

# CHAPTER 44



## Zoning

**Draft**

Adopted: XXXXXX, 2024

**THIS PAGE INTENTIONALLY LEFT BLANK**

# TABLE OF CONTENTS

<u>Section</u>	<u>Subject</u>	<u>Page</u>
<b>CHAPTER I - GENERAL PROVISIONS</b>		
Sec. 1.01	TITLE	1
Sec. 1.02	PURPOSE	1
Sec. 1.03	TERRITORY UNDER THE ZONING ORDINANCE	1
Sec. 1.04	APPLICABILITY AND COMPLIANCE	1
Sec. 1.05	TRANSITION RULES	2
Sec. 1.06	HOW TO USE THIS DOCUMENT	3
Sec. 1.07	INTERPRETATIONS	3
Sec. 1.08	INTERPRETATIONS OF TERMS OR WORDS	4
Sec. 1.09	ZONING MAP	4
Sec. 1.10	CONFLICT OF LAW	5
Sec. 1.11	SEVERABILITY CLAUSE	5
Sec. 1.12	REPEAL OF CONFLICTING ORDINANCE	5
Sec. 1.13	EFFECTIVE DATE	5
<b>CHAPTER II: ADMINISTRATION</b>		
Sec. 2.01	ENFORCEMENT	6
Sec. 2.02	PLANNING & ZONING COMMISSION	6
Sec. 2.03	COMMUNITY DEVELOPMENT DIRECTOR	9
Sec. 2.04	ZONING BOARD OF APPEALS	11
Sec. 2.05	HISTORIC PRESERVATION COMMISSION	12
Sec. 2.06	CITY COUNCIL	13
Sec. 2.07	TECHNICAL ADVISORY COMMITTEE	13
Sec. 2.08	PROCEDURES FOR CALLING AND CONDUCTING PUBLIC HEARINGS	14
<b>CHAPTER III: NONCONFORMITIES</b>		
Sec. 3.01	INTENT	17
Sec. 3.02	NONCONFORMING STATUS	17
Sec. 3.03	INCOMPATIBILITY OF A NONCONFORMING USE	17
Sec. 3.04	AVOIDANCE OF UNDUE HARDSHIP	17
Sec. 3.05	NONCONFORMING LOT OF RECORD	18
Sec. 3.06	NONCONFORMING USE OF LAND	18
Sec. 3.07	NONCONFORMING BUILDING OR STRUCTURE	18
Sec. 3.08	REPAIR AND MAINTENANCE	19
Sec. 3.09	RESTORATION OF A DESTROYED NONCONFORMING USE	20
Sec. 3.10	DETERMINATION OF A NONCONFORMING USE	20
Sec. 3.11	TRANSITIONAL USES IN MIXED-USE DISTRICTS	20
<b>CHAPTER IV: ZONING DISTRICTS</b>		
Sec. 4.01	ESTABLISHMENT OF DISTRICTS	22
Sec. 4.02	ZONING DISTRICT TRANSITION	22
Sec. 4.03	PERMITTED AND SPECIAL EXCEPTION USES	24
Sec. 4.04	LOT STANDARDS	30
Sec. 4.05	R-1 – SUBURBAN SINGLE-FAMILY RESIDENTIAL	36
Sec. 4.06	R-2 – URBAN SINGLE-FAMILY RESIDENTIAL	38
Sec. 4.07	R-3 – SINGLE-FAMILY HIGH DENSITY RESIDENTIAL	40
Sec. 4.08	TH – TOWNHOME RESIDENTIAL	46
Sec. 4.09	MF-1 – LOW-DENISTY MULTIFAMILY RESIDENTIAL	42
Sec. 4.10	MF-2 – MEDIUM-DENSITY MULTIFAMILY RESIDENTIAL	44
Sec. 4.11	TH – TOWNHOME RESIDENTIAL	46
Sec. 4.12	CBD – CENTRAL BUSINESS DISTRICT	48
Sec. 4.13	MXU – MIXED USE	50

# TABLE OF CONTENTS

<b>Section</b>	<b>Subject</b>	<b>Page</b>
Sec. 4.14	C-1 – LOW-DENSITY COMMERCIAL	52
Sec. 4.15	C-2 – MEDIUM-DENSITY COMMERCIAL	54
Sec. 4.16	OMI- OFFICE MEDICAL INSTITUTIONAL	56
Sec. 4.17	I-1 - LIGHT INDUSTRIAL	58
Sec. 4.18	I-2 - HEAVY INDUSTRIAL	60
<b>CHAPTER V: INFILL DEVELOPMENT STANDARDS</b>		
Sec. 5.01	INFILL DEVELOPMENT STANDARDS	63
Sec. 5.02	INFILL COMPATIBILITY EXAMPLES	67
<b>CHAPTER VI: PLANNED UNIT DEVELOPMENT</b>		
Sec. 6.01	PURPOSE	69
Sec. 6.02	PUD USES AND STANDARDS	69
Sec. 6.03	PROCEDURE SUMMARY	69
Sec. 6.04	PRE-SUBMITTAL CONFERENCE	70
Sec. 6.05	PUD DISTRICT ORDINANCE AND CONCEPT PLAN	70
Sec. 6.06	PRELIMINARY PLAT PROCEDURE	73
Sec. 6.07	FINAL PLAT	75
Sec. 6.08	ALTERNATIVE SUBMISSION FOR FINAL PLAT	77
Sec. 6.09	TIME LIMIT FOR APPROVED PUD MASTER PLAN	78
Sec. 6.10	PUD ABANDONMENT	79
Sec. 6.11	AMENDMENTS TO THE CONCEPT PLAN AND FINAL PLAT	79
Sec. 6.12	TRANSFERABILITY AND ENFORCEMENT OF STANDARDS	80
<b>CHAPTER VII: DEVELOPMENT STANDARDS</b>		
Sec. 7.01	INTRODUCTION AND APPLICATION	83
Sec. 7.02	OFF-STREET PARKING AND LOADING	84
Sec. 7.03	ENTRANCE/DRIVE STANDARDS	93
Sec. 7.04	SIGHT VISIBILITY	95
Sec. 7.05	LANDSCAPING STANDARDS	96
Sec. 7.06	TREE CONSERVATION	108
Sec. 7.07	REDEVELOPMENT SITES	116
Sec. 7.08	TREE CONSERVATION, BUFFERS, AND LANDSCAPE COMPLIANCE	116
Sec. 7.09	FENCES, WALLS, AND HEDGES	125
Sec. 7.10	HEIGHT STANDARDS	127
Sec. 7.11	WIRELESS COMMUNICATION FACILITIES	128
Sec. 7.12	OUTDOOR LIGHTING	131
Sec. 7.13	OPEN SPACE REQUIREMENT	138
Sec. 7.14	MULTIFAMILY AMENITIES REQUIRED	139
Sec. 7.15	MULTIFAMILY DENSITY BONUSES	140
Sec. 7.16	SINGLE-FAMILY DEVELOPMENT AMENITIES REQUIRED (R-1, R-2, R-3, PUD)	141
Sec. 7.17	MULTIFAMILY AND TOWNHOME LAYOUT AND SITE PLANNING	142
Sec. 7.18	COMMERCIAL AND INDUSTRIAL LAYOUT AND SITE PLANNING	143
<b>CHAPTER VIII: SUPPLEMENTARY STANDARDS FOR SPECIFIC USES</b>		
Sec. 8.01	GENERAL CONDITIONS	145
Sec. 8.02	ACCESSORY USE AND STRUCTURE STANDARDS	145
Sec. 8.03	TEMPORARY USE AND STRUCTURE STANDARDS	162
Sec. 8.04	SEXUALLY-ORIENTED BUSINESSES	165
Sec. 8.05	AMUSEMENT PARKS	166
Sec. 8.06	BED AND BREAKFAST ESTABLISHMENT	166
Sec. 8.07	CEMETERIES	167
Sec. 8.08	CHILDCARE	167

# TABLE OF CONTENTS

<u>Section</u>	<u>Subject</u>	<u>Page</u>
Sec. 8.09	DRIVE-IN ESTABLISHMENTS	168
Sec. 8.10	HOME-BASED BUSINESS	169
Sec. 8.11	NURSERIES AND GREENHOUSES	172
Sec. 8.12	OUTDOOR SALES, DISPLAY, AND STORAGE STANDARDS	172
Sec. 8.13	PERSONAL CARE HOMES	176
Sec. 8.14	PLACES OF WORSHIP	176
Sec. 8.15	SALVAGE OR JUNK YARDS	177
Sec. 8.16	STORAGE/MINI WAREHOUSE FACILITIES	178
Sec. 8.17	SWAP MEETS AND FLEA MARKETS	179
Sec. 8.18	TIRE SALES AND SERVICE	179
Sec. 8.19	VETERINARY CLINIC/ANIMAL CARE FACILITY	179
Sec. 8.20	MANUFACTURED HOMES	179
Sec. 8.21	CREMATORIES	180
Sec. 8.22	SMOKE SHOPS, TOBACCO STORES, AND MARIJUANA DISPENSARIES	180
Sec. 8.23	CULTIVATION OF MEDICAL MARIJUANA	181
Sec. 8.24	TRANSFER STATION/SOLID WASTE COLLECTION FACILITY	182
Sec. 8.25	RESTRICTIONS ON THE KEEPING OF FARM ANIMALS AND BEES	185
Sec. 8.26	FILM PRODUCTION	189
Sec. 8.27	LIQUOR STORES, PACKAGE STORES, AND LIQUOR OUTLETS	191
Sec. 8.28	SHIPPING CONTAINERS	191
Sec. 8.29	ROOFTOP DECKS/TERRACES	193
Sec. 8.30	ELECTRIC VEHICLE CHARGING STATIONS	195
<b>CHAPTER IX: DESIGN STANDARDS</b>		
Sec. 9.01	RESIDENTIAL DESIGN STANDARDS	199
Sec. 9.02	MULTIFAMILY AND TOWNHOME DESIGN STANDARDS RESIDENTIAL	204
Sec. 9.03	NON-RESIDENTIAL DESIGN STANDARDS	207
Sec. 9.04	COMMUNITY DESIGN CONSIDERATIONS	210
<b>CHAPTER X: HISTORIC PRESERVATION</b>		
Sec. 10.01	HISTORIC PRESERVATION	213
<b>CHAPTER XI: PETITIONS, PERMITS, AND PROCEDURES</b>		
Sec. 11.01	PURPOSE	223
Sec. 11.02	APPLICATION AND PERMIT TYPES	223
Sec. 11.03	DEVELOPMENT PLAN REVIEW AND APPROVAL	224
Sec. 11.04	WRITTEN COMMITMENTS	233
Sec. 11.05	ZONING AND FUTURE DEVELOPMENT MAP AND TEXT	233
Sec. 11.06	AMENDMENTS DEVELOPMENT STANDARDS VARIANCE	241
Sec. 11.07	ADMINISTRATIVE PLATS AND MINOR SUBDIVISIONS	239
Sec. 11.08	ADMINISTRATIVE ADJUSTMENTS	244
Sec. 11.09	SPECIAL EXCEPTION PROCEDURE	246
Sec. 11.10	PUBLIC NOTICE PROCEDURE	247
Sec. 11.11	ADMINISTRATIVE APPEALS PROCEDURE	248
Sec. 11.12	LAND DISTURBANCE PERMIT	249
Sec. 11.13	CERTIFICATE OF OCCUPANCY AND CERTIFICATE OF COMPLETION	251
Sec. 11.14	SIGN PERMIT	252
Sec. 11.15	SEXUALLY ORIENTED BUSINESS	254
Sec. 11.16	PERMIT FEES	258
Sec. 11.17	FOOD TRUCKS AND MOBILE FOOD VENDORS	258

# TABLE OF CONTENTS

<u>Section</u>	<u>Subject</u>	<u>Page</u>
<b>CHAPTER XII: VIOLATIONS AND ENFORCEMENT</b>		
Sec. 12.01	ENFORCEMENT	263
Sec. 12.02	ZONING VIOLATIONS	263
Sec. 12.03	CONSTRUCTION PROCESS VIOLATIONS	265
Sec. 12.04	IMMEDIATE PUBLIC RISK VIOLATIONS	266
Sec. 12.05	TRIAL FOR VIOLATIONS	266
Sec. 12.06	MONETARY FINE AND PENALTIES	267
<b>CHAPTER XIII: DEFINITIONS</b>		
Sec. 13.01	DEFINITIONS	269
<b>APPENDIX OF TABLES</b>		
Table 4.1	AGRICULTURAL AND RESIDENTIAL TRANSITIONAL DISTRICTS	21
Table 4.2	NON-RESIDENTIAL/NON-AGRICULTURAL TRANSITIONAL DISTRICTS	21
Table 4.3	PERMITTED AND CONDITIONAL USES	21
Table 4.4	RESIDENTIAL LOT STANDARDS	25
Table 4.5	NON-RESIDENTIAL LOT STANDARDS	34
Table 7.0	CHANGE OF USE CHART	83
Table 7.1	PARKING DIMENSIONS	85
Table 7.2	NUMBER OF LOADING SPACES	89
Table 7.3	PARKING FOR THE DISABLED	90
Table 7.4	MINIMUM PARKING SPACE REQUIREMENTS	91
Table 7.5	PARKING LOT ENTRANCE DRIVE LENGTH	94
Table 7.6	(RESERVED)	89
Table 7.7	INDIVIDUAL RESIDENTIAL LOT LANDSCAPE	103
Table 7.8	APPLICABLE BUFFER YARD TYPES	107
Table 7.9	BUFFER YARD TYPES DESCRIPTION	108
Table 7.10	UNIT VALUE OF LANDSCAPE MATERIAL	108
Table 7.11	TREE UNITS FOR EXISTING TREES	109
Table 7.12	TREE UNITS FOR NEW (REPLACEMENT) TREES	109
Table 7.13	TREES FOR PLANTING ON STREETS, HIGHWAYS, AND PARKING LOTS	119
Table 7.14	TREES . . . THAT MINIMIZE CONFLICTS WITH OVERHEAD UTILITIES	120
Table 7.15	ORNAMENTAL TREES FOR USE IN SITE INTERIOR OR BUFFER	120
Table 7.16	EVERGREEN TREES FOR USE IN SITE INTERIOR OR BUFFER	121
Table 7.17	VINES FOR WALLS AND FENCES	121
Table 7.18	SMALL SHRUBS APPROVED FOR SCREENS, HEDGES, AND SPECIMEN PLANTING	121
Table 7.19	LARGE SHRUBS APPROVED FOR SCREENS, HEDGES, AND SPECIMEN PLANTING	122
Table 7.20	SHRUBS APPROVED FOR BORDERS, PARKING ISLANDS, AND GROUNDCOVER	123
Table 7.21	NON-QUALIFYING TREES	124
Table 7.22	MAXIMUM PERMITTED FENCE HEIGHT	126
Table 7.23	LIGHT TRESPASS	131
Table 7.24	MINIMUM REQUIRED OPEN SPACE	139
Table 8.1	SPECIAL EVENTS PROCESS AND COMPONENTS	165
Table 8.2	STACKING SPACE SCHEDULE	169
Table 8.3	HOME BASED BUSINESS STANDARDS	172
Table 8.4	OPEN STORAGE BY DISTRICT AND LOCATION	173
Table 8.5	CULTIVATION LIMITS BASED ON CULTIVATION AREA	181
Table 8.6	CULTIVATION SETBACKS FROM PROPERTY LINES	182

**CHAPTER I – IN GENERAL****Sec. 1.01 – TITLE**

---

- 1) This Ordinance shall be known and may be cited and referred to as the “Unified Development Code” or “Zoning Ordinance of the City of Dallas, Georgia,” and shall be referred to as “this Ordinance.”

**Sec. 1.02 - PURPOSE**

---

- 1) The various use districts which are created by this Ordinance and the various sections of this Ordinance are adopted for the following purposes, among others:
  - a) To promote growth and development based on physical, social, and economic needs, environmental considerations, and public facilities and service.
  - b) To achieve such timing, density and distribution of land development and use as will prevent overloading public infrastructure systems for providing water supply, sewage disposal, drainage, sanitation, police protection, transportation and other public services;
  - c) To encourage such distribution and population, land development and use as will facilitate the efficient and adequate provision of public services and facilities;
  - d) To promote a diversified housing market. Encourage, promote and facilitate high quality design, construction and landscape measure for new developments in a variety of ways, including flexible zoning and development regulations, coherent development standards, and innovative planning ideas.
  - e) To achieve such density, design and distribution of housing as will protect and enhance residential property values;
  - f) To promote the health, safety, morals, convenience, order, prosperity and welfare of the present and future residents, and owners of property and those engaged in commerce in the City;
  - g) To preserve and enhance the City's natural beauty and encourage accessible and architecturally pleasing development;
  - h) Increase the viability of businesses in downtown Dallas.
  - i) To improve the quality of life through protection of the City's total environment including, but not limited to, the prevention of air, water and noise pollution, and;
  - j) To encourage and sustain the economic viability of the City.

**Sec. 1.03 - TERRITORY UNDER THE ZONING ORDINANCE**

---

- 1) This Ordinance shall be effective in the incorporated areas of the City of Dallas, Georgia. Upon annexation of territory into the City of Dallas, the County zoning regulations then in effect on that territory shall become null and void.

**Sec. 1.04 - APPLICABILITY AND COMPLIANCE**

---

- 1) All buildings erected hereafter, all uses of land or buildings established hereafter, all structural alterations, changes in site or site flow, and relocation of existing buildings occurring hereafter, and all enlargements of or additions to existing legally conforming uses exceeding thirty-five percent (35%) of the existing site or structure occurring hereafter as determined by the Community Development Director (“Director”) shall be subject to all the regulations of this Zoning Ordinance as they apply to the zoning districts in which such buildings or uses of land shall be located. A Site Plan is required for all changes of use except for uses within the CBD.
  - a) All changes of use proposed within existing structures on developed parcels shall be exempt from all supplementary regulations within this ordinance except parking, lighting and landscaping requirements.

- b) All changes of use proposed within new structures or structures expanded beyond 35% of the existing structure’s square footage on developed parcels shall be subject to all applicable regulations within this ordinance as set forth herein.
- c) All changes of use proposed within existing buildings, new buildings, or buildings expanded beyond thirty-five percent (35%) of the existing structure’s square footage, and located on underdeveloped or undeveloped lots shall be subject to all applicable regulations within this ordinance as set forth herein.

Table 1.1: Change of Use Chart

	Undeveloped Lot	Underdeveloped Lot	Developed Lot
Existing structure	All regulations	All regulations	Parking, Lighting and Landscaping Regulations
Expansions beyond 35% of a structure’s square footage	All regulations	All regulations	All regulations
New Structure	All regulations	All regulations	All regulations

- 2) This Ordinance shall not be construed as abating any action now pending under, or by virtue of, the prior existing zoning ordinance; or as discontinuing, abating, modifying, or altering any penalty accruing or about to accrue; or as affecting the liability of any person, firm, or corporation; or as waiving any right of the City of Dallas under any section or provision existing at the time of the effective date of this Ordinance; or as vacating or annulling any rights obtained by any person, firm, or corporation, by lawful action of the City, except as shall be expressly provided for in this Ordinance.
- 3) All variances and exceptions granted prior to the effective date of this Ordinance or any subsequent amendment thereto shall remain in full force and effect, and all terms, conditions and obligations imposed shall remain in effect and be binding. Prior ordinances shall remain in effect insofar as required for the initiation of any proceedings against these violations and for the prosecution of any violations heretofore commenced.
- 4) Nothing in this article shall require any change in the development or proposed use of properties which are legally under construction or for which a development plan or preliminary plat has been approved within 5 years of the effective date of this article and the development of which shall be commenced within one year after the effective date of the article. Actual construction is hereby defined to include the placing of construction materials in a permanent position and fastened in a permanent manner. Where excavation or demolition or removal of an existing building has been substantially begun preparatory to rebuilding, such excavation or demolition or removal shall be deemed to be actual construction, provided that work shall be carried on diligently.
- 5) See also *Chapter III: Nonconformities*.
- 6) Municipal, county, and state-owned properties shall be exempt from all use and use district regulations set forth within this ordinance. This section shall not be construed to exempt such uses and structures from following development or supplemental regulations found herein. Utility providers are subject to all regulations found within this ordinance unless otherwise indicated.

**Sec. 1.05 - TRANSITION RULES**

- 1) Any application that has been filed with the Planning & Zoning Commission or its designees and is full and complete, prior to the effective date of this Zoning Ordinance, shall be regulated by the terms and conditions of the Zoning Ordinance that was in place at the time of filing. However, all administrative procedures shall follow those set forth by this Zoning Ordinance.

**Sec. 1.06 - HOW TO USE THIS DOCUMENT**

- 1) STRUCTURE. The structure of the text of this Ordinance is as follows: Chapter (indicated by 1, etc.), Section (indicated by 1.1, etc.), and subsequent Subsections (indicated by a, i, etc.). Below is an example of this format:

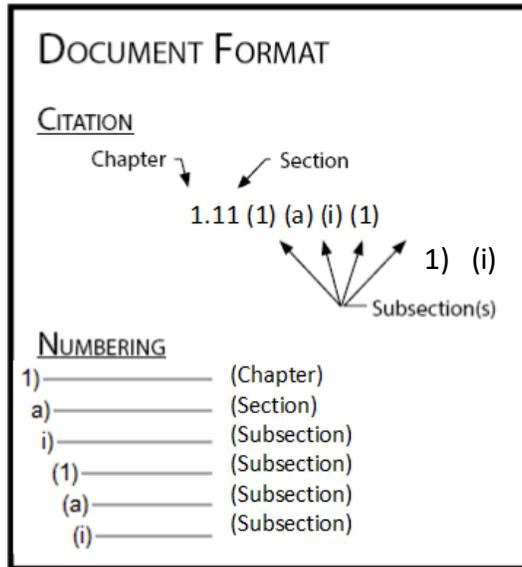

- 2) APPLICABLE DISTRICTS. Zoning district designation identifiers are located in various places throughout the document. If one of these identifiers appears within a section, then that section will apply to the corresponding zoning district. Samples of district identifiers follow:

R-1	• Low-Density Single-Family Residential
MF1	• Multi-Family Low Density
MXU	• Mixed Use
CBD	• Central Business District
C-1	• Neighborhood Commercial
I-1	• Light Industrial

**Sec. 1.07 – INTERPRETATIONS**

---

- 1) In their interpretation and application, the provisions of this Ordinance shall be held to be minimum or maximum requirements, adopted for the promotion of the public health, safety, and the general welfare.

**Sec. 1.08 - INTERPRETATION OF TERMS OR WORDS**

---

- 1) For the purpose of this Ordinance, certain terms or words are defined, and the words or terms used shall be interpreted as follows:
  - a) The word “person” includes a firm, association, organization, partnership, trust, company, corporation or other legal entity, as well as an individual;
  - b) The present tense includes the future tense, the singular number includes the plural, and the plural number includes the singular;
  - c) The word “shall” is a mandatory requirement, the word “may” is a permissive requirement, and the word “should” is a preferred requirement.
  - d) The words “used” or “occupied” include the words “intended, designed, constructed, converted, altered or arranged to be used or occupied”; and
  - e) The word “lot” includes the words “plot, tract, or parcel.”

**Sec. 1.09 - ZONING MAP**

---

- 1) OFFICIAL ZONING MAP. The city is divided into zones or districts as shown on the Official Zoning Map as amended, which, together with all explanatory matter, is adopted by reference and declared to be a part of this Ordinance. See also *Section 11.05 – Zoning Map and Text Amendments*.
- 2) LOCATION AND MAINTENANCE OF THE OFFICIAL ZONING MAP.
  - a) Regardless of the existence of copies of the official Zoning Map which, from time to time may be published, the Official Zoning Map shall be located in the office of the Community Development department. It shall be the final authority as to the current zoning status of land and water areas in the city. Current copies may be obtained from the Community Development department.
  - b) The official Zoning Map may be maintained in electronic form, and depicted in various formats and scales as appropriate to the need, under the direction of the Community Development Director.
  - c) No changes of any nature shall be made on the Official Zoning Map or shown except in conformity with the procedures set forth in this Ordinance. Any unauthorized change of any kind by a person or persons shall be considered a violation of this Ordinance and punishable as provided under *Chapter XII – Violations and Enforcement*.
- 3) REPLACEMENT OF THE OFFICIAL ZONING MAP. In the event that the official Zoning Map becomes damaged, destroyed, lost or difficult to interpret because of the nature or number of changes and additions or loss of electronic information, the Dallas City Council may, by Resolution, adopt a new Official Zoning Map which shall supersede the prior Official Zoning Map. The new Official Zoning Map may correct drafting or other errors or omissions in the prior Official Zoning Map, but no correction shall have the effect of amending the original Official Zoning Map or any subsequent amendment.
- 4) RULES FOR INTERPRETATION OF DISTRICT BOUNDARIES. Where uncertainty exists with respect to the boundaries of districts as shown on the Official Zoning Map, the following rules shall apply:
  - a) Boundaries indicated as approximately following the center lines of thoroughfares or highways, street lines or highway right-of-way lines, or alleys shall be construed to follow the centerlines;

- b) Boundaries indicated as approximately following platted lot lines shall be construed as following the lot line;
- c) Boundaries indicated as approximately following city limits shall be construed as following the City Limits;
- d) Boundaries indicated as following railroad lines shall be construed to be midway between the main tracks;
- e) Boundaries indicated as approximately following the centerlines of streams, rivers, canals, lakes or other bodies of water shall be construed to follow the centerlines;
- f) Boundaries indicated as approximately following floodplain lines shall be construed to follow the floodplain lines;
- g) Boundaries indicated as parallel to or extensions of features indicated in the subsections above shall be so controlled. Distances not specifically indicated on the Official Zoning Map shall be determined by the scale of the map by the Community Development Director;
- h) Where physical features existing on the ground are at variance with those shown as the Official Zoning Map, or in other circumstances not covered by the subsections above, the Community Development Director shall interpret the boundaries. The Dallas City Council shall hear appeals to the decision of the Community Development Director; and
- i) When a zoning district boundary line divides a lot or parcel, the Director shall determine the applicable zoning district. The Director may require a rezone or replat of the site if any portion of a construction or development proposal overlaps two (2) or more zoning districts. The petitioner shall be responsible for filing the appropriate forms and for paying the appropriate filing fees to rezone or replat the lot or parcel. If a portion of a lot or parcel is in an overlay district, the entire lot or parcel shall be deemed as being within the overlay district.

**Sec. 1.10 - CONFLICT OF LAW**

---

- 1) Whenever the regulations of this Ordinance require a greater width or size of setbacks or other open space, a lower height limit, greater percentage of lot to be left unoccupied, a lower density of development, a more restrictive use of land, or impose other higher standards than are required in any other lawfully adopted rules, regulations, ordinances, private deed restrictions or private covenants, these regulations shall govern.

**Sec. 1.11 - SEVERABILITY CLAUSE**

---

- 1) If any section, subsection, sentence, clause, phrase or portion of this Ordinance or any amendment thereto is for any reason held invalid or unconstitutional by any court of competent jurisdiction, such portion shall be deemed as a separate, distinct and independent provision and such holding shall not affect the validity of the remaining portions hereof.

**Sec. 1.12 - REPEAL OF CONFLICTING ORDINANCE**

---

- 1) All ordinances or parts of ordinances in conflict with this Zoning Ordinance or inconsistent with the provisions of this Ordinance are repealed to the extent necessary to give this Ordinance full force and effect.

**Sec. 1.13 - EFFECTIVE DATE**

---

- 1) This article shall be effective immediately upon its adoption by the Mayor and Council.

**CHAPTER II - ADMINISTRATION****Sec. 2.01 – ENFORCEMENT**

---

- 1) The Director of the Community Development department, or his/her designee, shall effect proper administration and enforcement of this Zoning Ordinance. *See also Chapter XII: Violations and Enforcement.*

**Sec. 2.02 – PLANNING & ZONING COMMISSION**

---

- 1) ESTABLISHMENT OF THE PLANNING & ZONING COMMISSION.
  - a) The Planning & Zoning Commission of Dallas shall be reconstituted and re-established in conformance with the Municipal Code. The Community Development Director, or his/her designee, shall serve as staff to the Commission.
    - i) Responsibilities. The Planning & Zoning Commission shall act in an advisory capacity to the City Council. In addition to any duties, responsibilities, or powers enumerated by the Council by resolution, ordinance, or the Municipal Code, the responsibilities of the Planning & Zoning Commission shall include:
      - 1) Conduct public hearings and makes recommendations on plan amendments, planned unit development, subdivisions, site plans as applicable, and zoning amendments;
      - 2) Recommend changes and amendments to the Zoning Map and the Code text;
      - 3) Conduct hearings and make recommendations on comprehensive plan amendments; and
      - 4) Make recommendations upon all other items referred to it by the City Council.
    - ii) Public Hearing Procedures
      - 1) Rules of Procedure. The Planning & Zoning Commission may adopt rules of procedure consistent with the provisions of this Code.
- 2) NOTICE OF MEETINGS.
  - a) Publication of the notice of public hearing and notification of affected property owners shall be done in conformance with *Section 11.05 – Zoning Map and Text Amendments* and *Section 2.08 – Procedure for Calling and Conducting Public Hearings* of this Code. The meeting agenda shall be posted in the City Clerk's Office prior to the scheduled meeting.
  - b) The posting of a written notice for at least 24 hours at the place of regular meetings and giving of written or oral notice at least 24 hours in advance of the meeting to the legal organ in which notices of sheriff's sales are published in the county where regular meetings are held is required. Alternative notice may be provided to a newspaper having a general circulation. O.C.G.A. § 50- 14-1(d).
  - c) The Agenda must provide for all matters expected to be considered O.C.G.A. § 50-14-1(e)(1).
  - d) Agenda shall be available upon request and posted at the meeting site, as far in advance of the meeting as reasonably possible, but not more than two weeks (14 days) prior. O.C.G.A. § 50-14-1(e)(1).
- 3) CONDUCT OF MEETINGS.
  - a) The planning commission shall adopt policies and procedures which govern the conduct of meetings and public hearings. The purpose of this section is to provide a limited time of equal duration for the proponents and opponents of recommendations brought before the commission. These procedures, to be available for distribution to the public, shall be as follows:

- i) The public hearing shall be called to order by the presiding officer;
  - ii) The presiding officer shall explain the procedures to be followed in the conduct of any public hearing on a proposed zoning decision;
  - iii) For each proposed zoning decision, if the subject of the public hearing is a rezoning request initiated by a petitioner other than the mayor and council, then the petitioner, or his representative, shall first present and explain the request for the rezoning. If the request for rezoning is initiated by the City of Dallas, or if the request is a zoning ordinance amendment, then the Dallas City Manager or his representative shall present and explain the request on behalf of the City of Dallas. Thereafter, all individuals that desire to speak in favor of the request shall be permitted to speak. The petitioner and those speaking in favor of the request shall be limited to 15 minutes total time for their presentation of data, evidence and opinion;
  - iv) For any proposed zoning decision, after all persons in favor of the request have spoken, then all individuals who desire to speak in opposition to the request, or amendment, shall have the opportunity to do so. All persons speaking in opposition to the application shall be limited to 15 minutes total time for their presentation of data, evidence and opinion;
  - v) When any person desires to speak, they shall first raise his/her hand and be recognized by the mayor or presiding officer, then stand and state his/her name and address and then shall make whatever comment that he/she has that is appropriate to the issue;
  - vi) Thereafter, the presiding officer shall declare the public hearing closed and either another public hearing shall be commenced for the next request, or the regular business session of the Dallas Planning Commission shall be convened.
    - 1) All meetings of the Planning & Zoning Commission shall be open to the public.
    - 2) The Planning Commission shall meet whenever any official business needs to be conducted or at such times as the chairperson may determine.
    - 3) Meetings shall be held at the city council room subject to the date and time as specified in the official meeting notice.
    - 4) A majority voting members of the Planning Commission shall constitute a quorum. A quorum shall be present before any business is conducted.
    - 5) All plans, reports, and recommendations of the planning commission shall be approved by at least a majority.
    - 6) A record of the vote of each member on each question shall be kept as a part of the minutes.
    - 7) All meetings of the planning commission at which official action is taken shall be open to the public.
    - 8) In the event of the absence of both the chairperson and vice-chairperson from a meeting, the members present may elect a temporary chairperson and proceed with the order of business.
- 4) MINUTES.
- a) The Planning & Zoning Commission shall keep minutes of its proceedings, showing the vote of each member upon each question, or, if absent or failing to vote, indicating such fact, and shall keep records of its deliberations and other official actions.
  - b) The minutes shall be filed in the office of the Community Development Director.
- 5) CONFLICT OF INTEREST.
- a) A member of the Commission shall inform the Commission before the commencement of the

public hearing, of any interest in the proposed action being reviewed by the Commission. The Commission Member shall not participate in any discussion or voting on any item for which the Commission Member or Commission Member's spouse, mother, father, children, siblings or in-laws has an interest.

6) EXPENSE REIMBURSEMENT.

- a) Members shall receive a payment per meeting to allow for expenses incurred in performing their duties; payment schedule maintained by the clerk in a separate schedule.

7) QUORUM.

- a) The Planning & Zoning Commission shall have a quorum present before considering any business. A quorum shall constitute a majority of the qualified members of the Commission. The affirmative vote of the majority of the members present shall be required before the Commission shall approve a recommendation, action or development request.

8) INVALIDITY OF A VOTE.

- a) If a Commission member votes on a recommendation in which the Commission member has a conflict of interest, the member's vote shall be voided.

9) MEMBERSHIP.

- a) The Planning & Zoning Commission of the City of Dallas shall be comprised of five (5) members who reside in the city limits of Dallas, Georgia. The members shall be appointed for two (2) year terms, as shown below and every two (2) years thereafter. If a member is appointed to fill a vacancy during a term, the replacement member shall serve the remaining balance of that term. All members shall continue to serve until their successor has been approved by the City Council. Terms are to begin January 1 of each calendar year.

- i) The current terms for all positions are as follows:

- 1) Position 1 – 01/01/2022 – 12/31/2025
- 2) Position 2 – 12/01/2022 – 12/31/2025
- 3) Position 3 – 01/01/2022 – 12/31/2025
- 4) Position 4 – 01/01/2023 – 12/31/2024
- 5) Position 5 – 01/01/2023 – 12/31/2024

- b) No member shall hold any elective public office within the City of Dallas. Unexpired terms shall be filled by the City Council. Members are removable for cause by the City Council upon written notice and after a public hearing.
- c) Failure to attend three (3) out of four consecutive meetings or more shall be considered automatic resignation from the Planning & Zoning Commission. Upon resignation by other means, or other vacancies occurring in office, the Chairman or Secretary (Zoning Administrator) shall inform the City Council of such occurrence as promptly as possible, so that the Council may appoint a replacement to fill the unexpired term.
- d) Officers, members and their duties.
  - i) Election of officers shall be held at the first official meeting of each year and those officers shall serve until reelected or successors are elected.
  - ii) Vacancies in the offices of the commission shall be filled at any official meeting.
  - iii) The offices of the planning commission shall consist of a chairperson, vice-chairperson and secretary. These officers shall be elected by the membership from its appointive members.
  - iv) The chairperson shall preside at meetings and hearings of the planning commission; have the privilege of discussing all matters before the planning commission and vote only in the case of a tie vote, and have the duties normally conferred by parliamentary procedure

on such officers.

- v) The vice-chairperson shall act for the chairperson in his absence and shall assume the duties of the chairperson upon vacancy of that office.
- vi) The secretary shall be responsible for official signatures on plats, reports, minutes, notices and other documents. All clerical duties of the secretary shall be performed by the city administrative department.
- vii) The city manager or his/her designee shall be a permanent nonvoting member of the planning commission and shall participate in any and all discussions.
- viii) The scope of duties of the planning commission shall be those contained in chapter 34, pertaining to zoning, and/or other ordinances of the city.

10) AUTHORITY.

- a) The Planning & Zoning Commission (“Commission”) is hereby authorized to perform those duties and functions specified in Georgia Planning Act (O.C.G.A. 45-12-200, et seq., and 50-8-1, et seq.) and other applicable sections of Georgia law and such other responsibilities as may be assigned to it from time to time by the Dallas City Council. For the purposes of this Zoning Ordinance, the duties of the Planning & Zoning Commission include:
  - i) Rules of Procedure. The Commission shall adopt written rules of procedure for the administration of the affairs of the Commission and its staff for filing, noticing and hearings. Refer to the Dallas Planning & Zoning Commission Rules of Procedures, as amended;
  - ii) Record Keeping. Maintain a complete record of all proceedings;
  - iii) Meeting Time and Records. Fix the time for holding regular meetings each month, or as necessary, keep minutes of all meetings, and maintain all minutes and records in the office of the Commission;
  - iv) Certification. Adopt a seal and certify all official acts;
  - v) Recommendations. Make recommendations to the participating legislative bodies concerning the adoption and amendment of the Comprehensive Plan, the Zoning Ordinance (including the Zoning Map), the Dallas Development Regulations, and Planned Unit Development district ordinances;
  - vi) Surety. Assume responsibility for the custody and preservation of all Commission documents and papers;
  - vii) Publications. Prepare, publish, and distribute reports, ordinances, and other material relating to the activities authorized by the Georgia Code;
  - viii) Modification. The Planning & Zoning Commission may initiate modifications to the standards of this Zoning Ordinance. Modifications recommended by the Planning & Zoning Commission shall be subject to the approval of the City Council as a text amendment to the Zoning Ordinance.
  - ix) Other Duties. All additional duties as established by Georgia Code.

11) AMENDMENTS.

- a) These bylaws may be amended by a two-thirds vote of the membership of the planning commission subject to an ordinance amendment by the mayor and council of the city.

**Sec. 2.03 - COMMUNITY DEVELOPMENT DIRECTOR**

---

- 1) ENFORCEMENT. The Director of the Community Development department (referred to as the “Director” for the purposes of this Ordinance), including his/her designee(s), will have the principal

responsibility for the administration and enforcement of this Ordinance. The authority to perform inspections, review applications, and issue permits may be delegated to other officials by the Director. In the performance of these functions, the Director and his/her appointed officials shall be responsible to the Planning & Zoning Commission, Zoning Board of Appeals, Historic Preservation Commission and the Dallas City Council (“boards/commissions”). The duties delegated by the City Council to the Director, or his/her designee shall include, but not be limited to the following.

2) BASIC DUTIES

- a) Interpretation. Provide interpretation of the “City of Dallas Zoning Ordinance” when necessary and provide such technical and clerical assistance as the Planning & Zoning Commission, Zoning Board of Appeals, Historic Preservation Commission and Dallas City Council may require.
- b) Maintenance. Provide and maintain a public information service relative to all matters of the commissions/boards and arising out of the “City of Dallas Zoning Ordinance.”
- c) Land Disturbance Permits. Reviewing, approving, or disapproving all Land Disturbance Permits and keeping permanent records of applications made and actions taken;
- d) Inspections. Conducting inspections of structures and properties to determine compliance with the requirements of this Ordinance and all approvals granted by the commissions/boards in the execution of its duties as established by this Ordinance and the Georgia Code;
- e) Record Keeping. Maintaining permanent and current records documenting the application of this Ordinance including, but not limited to, all maps, amendments, Special Exceptions, variances, and appeals;
- f) Board/Commission Applications. Receiving, processing, docketing, and referring to the appropriate board/commission all applications and other matters upon which it is authorized to act under this Ordinance and Georgia Code;
- g) Dallas City Council Applications. Receiving, processing, docketing, and referring to the Dallas City Council all rezoning and annexation requests;
- h) Clerical & Technical Assistance. Providing all such clerical and technical assistance as may be required by the Dallas City Council, Planning & Zoning Commission, Legislative Bodies, or other body in the execution of its duties as established by this Ordinance and Georgia Code.
- i) Provide Information. Provide information to the boards/commissions and maintain permanent and current records arising from the administration of the “City of Dallas Zoning Ordinance,” including but not limited to, all maps, amendments, Improvement Land Disturbance Permits, Certificates of Occupancy, Certificates of Completion, Certificates of Appropriateness, Variances, Special Exceptions and appeals, and applications thereof, and records of hearings thereon.
- j) Planning and Zoning Commission Recommendations. The Director, or his designee, shall report the actions and recommendations of the Planning and Zoning Commission to the City Council at the time those recommendations are made to the council.
- k) Research and Analysis. Conduct research and collect and analyze, on a continuing basis, all pertinent data on the growth and development of the city in order to provide a foundation for a planning program.

- i) Fee Basis. All fees shall be intended to reimburse the City for the time and cost of processing the required materials. In no instance shall a fee be used as a means of discouraging or encouraging any particular types of applications.
  - ii) Public Access. The fee schedule shall be made available to the public by the Director.
  - iii) Establishment and Revisions. The fee schedule shall be prepared by the Director and adopted by the Dallas City Council as applicable.
  - iv) Payment Required. Until all applicable fees have been paid in full, no action shall be taken on any application or petition.
  - v) Fines for Failing to Obtain a Permit. The Director may require any person who initiates construction of a structure or the alteration of land prior to obtaining any required permit to pay up to three (3) times the amount of the normal permit fee listed on the fee schedule as a penalty. In addition to any other enforcement action, the Director may recover a reasonable attorney fee incurred in the enforcement of any provision of this Ordinance.
- 3) APPEALING A DECISION OF THE DIRECTOR. Recourse from the decision of the Director shall be to the Zoning Board of Appeals on matters pertaining to zoning and shall be made in accordance with *Section 11.11 – Administrative Appeals Procedure* and the Zoning Board of Appeals Rules of Procedure. Recourse from the decision of the Zoning Board of Appeals shall be to the Dallas City Council. Recourse from the decision of the City Council shall be to the courts as provided by law.

#### Sec. 2.04 – ZONING BOARD OF APPEALS

---

- 1) ESTABLISHMENT AND PROCEDURES OF THE ZONING BOARD OF APPEALS
  - a) The intent of this Section is to establish the validity of the Zoning Board of Appeals (ZBA) and empower the ZBA as the body of adjudication on appeals of the Zoning Ordinance, process variances and special exceptions, and/or decisions of the Community Development Director on matters of zoning appeal.
- 2) DUTIES OF THE ZONING BOARD OF APPEALS
  - a) For the purpose of this Ordinance the Zoning Board of Appeals has the following specific responsibilities:
    - i) Development Standards Variances.

The Zoning Board of Appeals shall approve or deny variances from all individual standards found within the Zoning Ordinance in accordance with the Georgia Planning Act (O.C.G.A. 36-66-1, et seq.; 36-67-1, et seq.; and, 36-67A-1, et seq.). Variances shall not be granted from standardized procedural or administrative policies found within the Zoning Ordinance. A variance may be approved only upon a determination in writing that:

      - a) The approval will not be injurious to the public health, safety, morals, and general welfare of the community;
      - b) The use and value of the area adjacent to the property included in the variance will not be affected in a substantially adverse manner; and
      - c) The strict application of the terms of the Zoning Ordinance will result in practical difficulties in the use of the property.
    - 2) Variance procedures can be found in *Chapter XI: Petitions, Permits, and Procedures.*
  - ii) Appeals. The Zoning Board of Appeals shall hear and determine all appeals from any

decision or action in the administration or enforcement of the Zoning Ordinance. The Zoning Board of Appeals shall hear and determine all appeals from the refusal to issue permits. The board may decide appeals by reversing or affirming, wholly or in part, or by modifying such decision, action or refusal.

iii) Special Use Permits. Conduct hearings and make decisions on Special Use Permits.

3) SUPPLEMENTARY CONDITIONS OF APPROVAL

a) In granting any appeal or variance, the Zoning Board of Appeals may prescribe appropriate conditions of approval in conformity with this Ordinance. Violation of the conditions, when made a part of the terms under which the appeal or variance is granted, shall be deemed a violation of this Ordinance and punishable under *Chapter XII: Violations and Enforcement*.

**Sec. 2.05 – HISTORIC PRESERVATION COMMISSION**

---

1) ESTABLISHMENT OF THE HISTORIC PRESERVATION COMMISSION:

a) There is hereby created a commission whose title shall be the "DALLAS HISTORIC PRESERVATION COMMISSION" (hereinafter "commission").

b) Commission position within the City of Dallas: The commission shall be part of the planning functions of the city.

c) Commission members:

i) The commission shall consist of seven members appointed by the mayor and ratified by the city council. All members shall be residents of the city and shall be persons who have demonstrated special interest, experience, or education in history, architecture, or the preservation of historic resources.

ii) To the extent available in the city, at least three members shall be appointed from among professionals in the disciplines of architecture, history, architectural history, planning, archaeology, or related professions.

iii) Members shall serve three-year terms. Members shall receive a payment per meeting attended to allow for expenses incurred in performing their duties; such payment is maintained by the clerk in a separate schedule.

d) Statement of commission's powers:

(i) The commission shall be authorized to:

- 1) Prepare and maintain an inventory of all property within the city having the potential for designation as historic property;
- 2) Recommend to the city council specific districts, sites, buildings, structures, or objects to be designated by ordinance as historic properties or historic districts;
- 3) Review applications for certificates of appropriateness, and grant or deny the same in accordance with the provisions of this chapter;
- 4) Recommend to the city council that the designation of any district, site, building, structure, or object as a historic property or as a historic district be revoked or removed;
- 5) Restore or preserve any historic properties acquired by the city
- 6) Promote the acquisition by the city of facade easements and conservation easements, as appropriate, in accordance with the provisions of the Georgia Uniform Conservation Easement Act of 1992 (O.C.G.A., §§ 44-10.1 through 44-10.5);
- 7) Conduct educational programs on historic properties located within the city and on general historic preservation activities;
- 8) Make such investigations and studies of matters relating to historic preservation, including consultation with historic preservation experts, that the city council or the commission itself may, from time to time, deem necessary or appropriate for the purposes of preserving historic resources;
- 9) Seek out local, state, federal, or private funds for historic preservation, and make

- recommendations to the city council concerning the most appropriate uses of any funds acquired;
- 10) Submit to the Historic Preservation Division of the Department of Natural Resources a list of historic properties or historic districts designated;
  - 11) Perform historic preservation activities as the official agency of the city historic preservation program;
  - 12) Employ persons, if necessary, to carry out the responsibilities of the commission subject to city budget appropriations and city employee regulations;
  - 13) Receive donations, grants, funds, or gifts of historic property and acquire and sell historic properties. The commission shall not obligate the city without prior consent;
  - 14) Review and make comments to the Historic Preservation Division of the Department of Natural Resources concerning the nomination of properties within its jurisdiction to the National Register of Historic Places; and
  - 15) Participate in private, state, and federal historic preservation programs and with the consent of the city council, enter into agreements to do the same.
- 2) PROCEDURES
- a) Chapter X of this ordinance shall be known as the “Historic Preservation Ordinance” and govern all hearings, appeals, and procedures of this commission.

### Sec. 2.06 – CITY COUNCIL

---

- 1) DALLAS CITY COUNCIL ESTABLISHMENT AND PROCEDURES
  - a) Refer to O.C.G.A. 45-12-200, et seq. and the City of Dallas City Council Rules of Procedure, as amended, for regulations and rules. The intent of this Section is not to establish the validity of the City Council, but to empower the City Council as the body to decide all rezoning and annexation requests.
- 2) DUTIES OF THE DALLAS CITY COUNCIL
  - a) For the purpose of this Ordinance the Council has the following specific responsibilities:
    - i) Rezoning. To grant, approve or deny all petitions for rezoning as specified in each zoning district and under the procedures per Chapter XI: Petitions, Permits, and Procedures and the Dallas City Council Rules of Procedure.
    - ii) Annexation. Georgia’s Zoning Procedures Act (ZPA), O.C.G.A. 36-66, defines a "zoning decision" as, among other things, "The adoption of an amendment to a zoning ordinance by a municipal local government which zones property to be annexed into the municipality." Thus, adopting any zoning on an annexed property is subject to the ZPA.
    - iii) Comprehensive Plan Amendments. Amendments to the Comprehensive Plan can be initiated by the City Council as an annual update or for specific purposes, including the annexation of property into the city and modifications to the Future Development Map, under the procedures per Chapter XI: Petitions, Permits, and Procedures.
    - iv) Zoning Text Amendments. City staff, the Planning Commission, and the City Council can initiate a text amendment in whole or in part of the Dallas Zoning Ordinance. Procedures are subject to the requirements outlined in Chapter XI: Petitions, Permits, and subject the requirements of Georgia’s Zoning Procedures Act. O.C.G.A. 36-66, and are subject to the final approval of the City Council.

### Sec. 2.07 – TECHNICAL ADVISORY COMMITTEE

---

- 1) As directed by the City Council, the City shall convene a Technical Advisory Committee (“TAC”)

comprised of select representatives of key City departments and other agencies. At a minimum, the City Engineer, Community Development Director and Public Works Director shall be members of the TAC. The TAC shall meet with the project applicant as necessary to discuss key project issues and shall review technical matters as appropriate. The TAC shall provide the applicant with information regarding City policy, standards and guidelines in response to the proposed project. The TAC is advisory; the City shall have the authority to determine adequacy of all documents.

### Sec. 2.08 – PROCEDURES FOR CALLING AND CONDUCTING PUBLIC HEARINGS

- 1) *Applicability.* Public hearings held by the City Council as required by this ordinance with regard to rezoning requests (amendments to the official zoning map), applications for conditional uses, applications for variances, and appeals of any administrative decision shall be called and conducted in accordance with the procedures of this section. The City Clerk shall print and make available for distribution to the general public the procedures for the conduct of public hearings as well as the standards to be applied by the Council in making zoning decisions.
- 2) *Presiding officer.* The presiding officer shall preside over the public hearing. In the case of the City Council, the Mayor shall preside, or in the absence of the Mayor the Mayor Pro Tempore shall preside, or in the absence of both the Mayor and Mayor Pro Tempore another member of the City Council shall be designated to preside, over the public hearing.
- 3) *Opening of public hearing.* The presiding officer shall indicate that a public hearing has been called on one or more applications made pursuant to this ordinance shall summarize the processes required by this article (or call on the Community Development Director to summarize), and shall open the public hearing. Thereupon, the presiding officer shall call the first case and the City Council shall consider each application on an individual basis in succession as printed on the published agenda or as otherwise approved by the City Council; provided, however, that the presiding officer may at his discretion call and consider more than one application simultaneously when more than one application involves the same piece of property, and/or when proceedings would be efficiently completed by combining separately required public hearings and discussing more than one scheduled matter as a single group of applications.
- 4) *Report of Community Development Director.* Upon opening the public hearing, the presiding officer may recognize the Community Development Director, who may provide a summary of the application and present any recommendations or results of investigations. Any member of the City Council upon recognition by the presiding officer may ask questions of the Community Development Director or designee or other city or planning commission representative providing a report or recommendations. The Community Development Director may be represented at the public hearing by written report in lieu of oral testimony.
- 5) *Identification of speakers.* Prior to speaking, each speaker (including applicant, agent of applicant, and all others) must identify himself and state his current address for the record. The presiding officer may require a speaker to complete an information card supplying such information, prior to testifying.
- 6) *Applicant and those in favor of the application.* When an individual application comes up for hearing, the presiding officer may ask for a show of hands of those persons who wish to appear in support of the application. If it appears that the number of persons wishing to appear in support of the application is in

excess of those who may reasonably be heard, the presiding officer may request that a spokesperson for the group be chosen to make presentations. Following the report of the Community Development Director or designee, or planning commission spokesperson, if any, the presiding officer shall recognize the applicant or his agent, spokesperson, or each of them, who shall present and explain the application, followed by any other persons wishing to speak in favor of the application. It shall be the duty of the applicant to carry the burden of proof that approval of the proposed application will promote the public health, safety, or general welfare. There shall be a minimum time period of ten minutes per application at the public hearing for the applicant and/or agent and anyone in favor of the application to present data, evidence, and opinions. The City Council shall not be obligated to provide the full ten-minute period to the proponents if they elect not to use that much time, nor shall there be an obligation to provide a minimum of ten minutes per application in the event that more than one application involving the same property is heard simultaneously. A maximum of fifteen minutes shall be allotted. An applicant or agent may reserve any remaining unused time from the allotted time period for rebuttal. Upon the completion of testimony or remarks by the applicant and/or applicant's agent and those speaking in favor of the application, any member of the City Council upon recognition by the presiding officer may ask questions of the applicant or agent of the applicant, or both, or any person speaking in favor of the application.

- 7) *Questions and opposing public comments on the application.* At the conclusion of the applicant's presentation and any testimony by others in favor of the application, the presiding officer shall call for public comments from those who wish to ask questions, make comments or oppose the application. The presiding officer may ask for a show of hands of those persons who wish to ask questions, make comments, and/or speak in opposition to the application. If it appears that the number of persons wishing to ask questions, make comments, and/or speak in opposition to the application is in excess of those who may reasonably be heard, the presiding officer may request that a spokesperson for the group be chosen to make presentations, ask questions, or speak in opposition. There shall be a minimum time period of ten minutes per application at the public hearing for the opponents to present data, evidence, and opinions and ask questions. The City Council shall not be obligated to provide the full ten minutes per application to the opponents if they elect not to use that much time, nor shall there be an obligation to provide a minimum of ten minutes per application in the event that more than one application involving the same property is heard simultaneously. A maximum of fifteen minutes shall be allotted. Upon the completion of testimony or remarks by those asking questions and/or speaking in opposition to the application, any member of the City Council upon recognition by the presiding officer may ask questions of those speakers.
- 8) *Response to questions.* Upon the completion of testimony or remarks by those asking questions and/or speaking in opposition to the application, the presiding officer may ask the Community Development Director, if present, to answer questions posed by speakers; answer such questions himself; recognize a member of the City Council to make remarks or answer questions in response to such questions; or defer questions to the applicant to be answered during rebuttal.
- 9) *Content of remarks.* Each speaker shall speak only to the merits of the proposed application under consideration and shall address his remarks only to the City Council and not directly to the audience. Each speaker shall refrain from personal attacks on any other speaker or the discussion of facts or opinions irrelevant to the proposed application under consideration. The presiding officer may limit or refuse a speaker the right to continue, if the speaker, after first being cautioned, continues to violate this

procedure.

- 10) *Applicant's rebuttal.* Upon the conclusion of public testimony, if the ten minutes allotted to the applicant and those speaking in favor of the application has not been exhausted, the applicant or his agent, or both, shall be allowed the remaining time from the total ten minutes allotted to answer questions, rebut the testimony of speakers, and/or provide final comments and remarks. The time devoted to any such rebuttal shall be counted toward the total ten minutes allotted to the applicant if such a time limit is set by the presiding officer. Any member of the City Council upon recognition by the presiding officer may then ask questions of the applicant, his agent, or both.
- 11) *Equal time.* In no event shall this section be interpreted to, and in no case shall the presiding officer allow or permit, an unequal amount of time to proponents and opponents with respect to testimony regarding an individual application.
- 12) *Close of hearing.* After the foregoing procedures have been completed, the presiding officer will close the public hearing and indicate that the public hearing is closed. Upon the closing of the public hearing, the applicant or his agent and any member of the public shall no longer be permitted to address the City Council in any way, including hand waving or motions for attention; provided, however, that at any time considered appropriate the presiding officer may reopen the public hearing for a limited time and purpose.
- 13) *Decision.* After the public hearing is closed, the City Council may either vote upon the application or may delay its vote to a subsequent meeting, subject to the limitations of this article, provided that notice of the time, date and location when such application will be further considered shall be announced at the meeting during which the public hearing is held. After hearing evidence, in making a decision, the City Council will apply the evidence to the criteria specified in this article for the application in question and other considerations and recommendations as may be considered appropriate. If the City Council determines from the evidence presented by the applicant has shown that the proposed application promotes the health, safety, and general welfare under applicable criteria, then the application shall be granted, subject to those reasonable conditions as may be imposed by the City Council on its own initiative or as recommended by the Community Development Director. Otherwise, such application shall be denied.
- 14) *Judicial review.* Decisions by the City Council with regard to variances are final; provided, however, any person or persons, jointly or severally, aggrieved by any decision of the City Council with regard to a decision on a variance application under the terms of this section may take an appeal to or seek judicial review by the County Superior Court. Any person, persons or entities jointly or severally may appeal in accord with O.C.G.A. § 36-66-5.1(1). The City Clerk, on behalf of the Mayor and Council, shall have the authority to approve or issue any form or certificate necessary to perfect the petition for review of any lower judicatory bodies and shall have the authority to accept service of such petition on behalf of the lower judicatory board or agency. Any such certificate, form or service shall be delivered to Dallas City Hall during normal business hours.

**CHAPTER III - NONCONFORMITIES****Sec. 3.01- INTENT**

---

- 1) This Ordinance allows legally established nonconforming uses based on the fact that within the districts established by this Ordinance or amendments that may later be adopted there exist lots, uses of land, structures, and uses of structures and land in combination which were lawful before this Ordinance was passed and amended, but which would be prohibited, regulated, or restricted under the terms of this Ordinance or future amendments; and
- 2) It is the intent of this Ordinance to permit legally established nonconforming uses, buildings, sites, and structures to continue until they are removed, abandoned, or fully conform with this Ordinance, but not to encourage their survival in nonconforming status. It is further the intent of this Ordinance that legal nonconforming uses shall not be enlarged upon, expanded or extended, nor be used as grounds for adding other structures or uses prohibited elsewhere in the same district without approval from the Dallas City Council or Zoning Board of Appeals in accordance with *Section 2.04 – Zoning Board of Appeals* and *Dallas City Council*, in this Article.

**Sec. 3.02 - NONCONFORMING STATUS**

---

- 1) The determination of status of Illegal Nonconforming and Legal Nonconforming (“Grandfathered”) uses, buildings, structures, or lots shall be based on the definition for each type of nonconforming use as they appear in *Chapter XIII: Definitions*.
  - a) Illegal Nonconforming. An illegal nonconforming use, structure, or lot shall be subject to actions and penalties allowed by this Ordinance and shall be altered to conform with all applicable standards and regulations of this Ordinance and all other applicable City ordinances.
  - b) Legal Nonconforming (“Grandfathered”). Legal nonconforming differs from illegal nonconforming in that the reason for the nonconformance is caused by the enactment of a Zoning Ordinance or a change to a Zoning Ordinance (including the official Zoning Map). Legally established nonconforming use of structures and/or land may continue operation or use in conformance with this Chapter.

**Sec. 3.03 - INCOMPATIBILITY OF A NONCONFORMING USE**

---

- 1) Legally established nonconforming uses are declared by this Ordinance to be incompatible with permitted uses in the districts in which the use is located. A legally established nonconforming use of a structure, a nonconforming use of land, or a nonconforming use of a structure and land in combination shall not be extended, expanded or enlarged after passage of this Ordinance.

**Sec. 3.04 AVOIDANCE OF UNDUE HARDSHIP**

---

- 1) Nothing in this Ordinance shall be deemed to require a change in the plans, construction, or designated use of any building on which actual construction was lawfully begun prior to the effective date of adoption or amendment of this Ordinance and upon which actual building construction has been carried on diligently.

**Sec. 3.05 - NONCONFORMING LOT OF RECORD**

---

- 1) Any legally established lot, as defined by this Ordinance, having less than the required minimum lot area or minimum lot width and frontage required by the applicable zoning district regulations of this Ordinance, may be deemed to be an exception to such minimum lot area or minimum lot width and frontage. This provision may apply even though such lots fail to meet the requirements for area, width, frontage, or any combination required by the applicable zoning district regulations of this Ordinance.
- 2) All other development standards for the applicable zoning district must be met unless property is determined to be an infill development.

**Sec. 3.06 - NONCONFORMING USE OF LAND**

---

- 1) Where, at the time of adoption of this Ordinance, lawful uses of land exist which would not be permitted by the regulations imposed by this Ordinance, the uses may be continued so long as they remain otherwise lawful, provided:
  - a) a nonconforming use shall not be enlarged or increased, nor extended to occupy a greater area of land than was occupied at the effective date of adoption or amendment of this Ordinance;
  - b) a nonconforming use shall not be moved in whole or in part to any portion of the lot other than that occupied by the uses at the effective date of adoption or amendment of this Ordinance;
  - c) a nonconforming use may be extended throughout any parts of an existing structure which was plainly arranged or designed for such use at the effective date of this Ordinance or its subsequent amendments, but no such use shall be extended to occupy land outside of the structure;
  - d) if a nonconforming use of land is discontinued or abandoned for more than six (6) months, the subsequent use of the land shall conform to the regulations specified by this Ordinance for the zoning district in which the land is located; and
    - i) Nonconforming mobile homes units that have been discontinued or abandoned for more than one (1) year shall not be reestablished unless entirely conforming to the regulations within the applicable zoning district.
  - e) no additional building or structure not conforming to the requirements of this Ordinance shall be erected in connection with a nonconforming use of land.

**Sec. 3.07 - NONCONFORMING BUILDING OR STRUCTURE**

---

- 1) CONTINUANCE OF LEGAL NONCONFORMING USE/STRUCTURE. Where a lawful building or structure exists, at the effective date of adoption or amendment of this Ordinance, that could not be built under the terms of this Ordinance by reason of restrictions on area, lot coverage, height, yards, location on the lot, bulk, or other requirements concerning the building or structure, the building or structure may remain so long as it remains otherwise lawful, subject to the following provisions:
  - a) A nonconforming building or structure may not be enlarged or altered in a way which increases its nonconformity, but any building or structure may be altered to decrease its nonconformity;
  - b) Any nonconforming building or use which is damaged or destroyed, by fire, explosion, or Act of God, may be restored or replaced to the extent of its existence immediately prior to such damage or destruction, provided that required permits for such restoration or replacement are secured, work on restoration or replacement is initiated within a period of one year (12 months) from the date of the damage or destruction, and such restoration or replacement complies with any nuisance abatement requirements. In addition, with the exception of single-family detached dwellings, such restoration or replacement shall comply with current building, architectural, and zoning code

- structural and dimensional requirements; and
- c) If a nonconforming building or structure is altered or moved for any reason for any distance or replaced, it shall thereafter conform to the regulations for the zoning district in which it is located and the discontinued legal nonconforming features shall not be resumed.
- 2) EXCEPTION. A legal nonconforming single-family or two-family residence and/or its accessory structures which are located in a non-residential zoning district, but within an area that has developed primarily as a residential neighborhood, may be expanded and the expansion shall be for the purpose of continuing the residential use of the property. The residential structure shall comply with the current setbacks required in the zoning district which most resembles the existing residential development in the area.
- a) Any nonconforming structure or portion of a non-conforming structure may be altered to decrease its non-conformity, or in a way that neither increases nor decreases the non-conformity.

Figure 3.1: Additions to a Nonconforming Structure

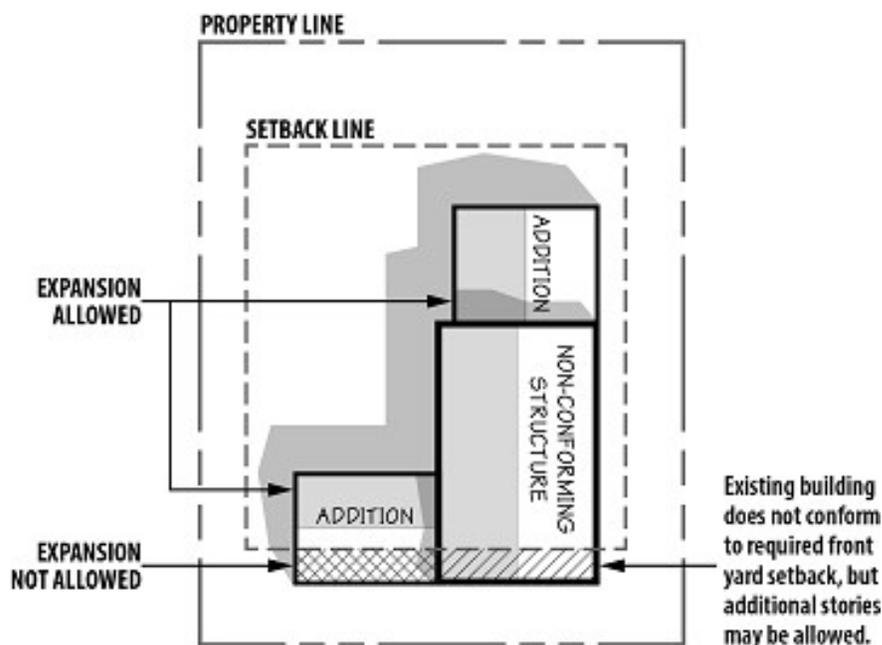

### Sec. 3.08 - REPAIR AND MAINTENANCE

- 1) On any legally established building or structure, or portion of a building or structure, or a building or structure containing a legally established nonconforming use, work may be done on ordinary repairs, or on repair or replacement of bearing and non-bearing walls, fixtures, wiring, or plumbing, provided that the cubic area existing when it became nonconforming shall not be increased. Nothing in this section shall be deemed to prevent the strengthening or restoring to a safe condition of any building or structure or portion of any building or structure declared to be unsafe by any official charged with protecting the public safety, upon order of such official.
- 2) If a legally established building or structure or portion of a building or structure or a building or structure containing a legally established nonconforming use becomes unsafe or unlawful by reason of physical condition and is razed, such building or structure shall not thereafter be rebuilt or used except in conformity with the regulations of the zoning district in which it is located.

**Sec. 3.09 – RESTORATION OF A DESTROYED NONCONFORMING USE**

---

- 1) A non-conforming building which has been damaged by accidental fire, explosion, or act of God to the extent of more than fifty percent (50%) of its reproduction value shall not be restored except in conformity with the regulations of the district in which it is located. When damaged by less than fifty percent (50%) of its reproduction value, a non-conforming building may be repaired or reconstructed and used as before the time of damage, provided that all portions of the structure being restored are not and were not on or over the property line, the non-conformity is not increased, and a Certificate of Occupancy is issued within one year of the date of the damage.

**Sec. 3.10 - DETERMINATION OF A NONCONFORMING USE**

---

- 1) In circumstances where there is question whether or not a legal nonconforming use exists, it shall be decided by the Community Development Director.

**Sec. 3.11 – TRANSITIONAL USES IN MIXED-USE DISTRICTS**

---

- 1) In the Mixed Use (MXU) zoning district, existing single-family residential structures may continue to function as legally nonconforming uses under *Chapter III - Nonconformities* of this ordinance, except where said structures have not been occupied or established as a vested right at the adoption of this ordinance.
  - a) At no time shall an established single-family residential structure be subdivided so as to increase the number of residential units in said structure.
- 2) Structures originally constructed for single-family residential use, may be converted to a neighborhood commercial use in *Table 4.3: Permitted and Conditional Uses*, subject to commercial building codes and off-street parking requirements for specific development types.
- 3) Structures originally developed as single-family residential uses, and converted to a commercial use, may be restored to a single-family residential use so long as applicable residential building codes have been met.
- 4) Structures developed for commercial use shall not be converted to a residential use, except for a commercial/residential mixed-use conversion, where residential living space is located above a commercial use at street-level.

CHAPTER IV – ZONING DISTRICTS

**Sec. 4.01 - ESTABLISHMENT OF DISTRICTS**

1) ZONING DISTRICTS ESTABLISHED. the following zoning districts are established:

a) Residential Districts

- i) "R-1" Low-Density Single-Family Residential District
- ii) "R-2" Medium-Density Single-Family Residential District
- iii) "R-3" High-Density Single-Family Residential District
- iv) "TH" Townhome Residential District
- v) "MF-1" Low-Density Multi-Family Residential District
- vi) "MF-2" Medium-Density Multi-Family Residential District

Table 4.1: Residential Transitional Districts	
Previously Established Zoning District	Newly Established Zoning District
R-1	R-1
R-2	R-1 R-2
R-3	R-2, R-3, TH, MF-1, MF-2
R-4	TH, MF1, MF2

b) Commercial Districts

- i) "CBD", Central Business District
- ii) "MXU" Mixed-Use District
- iii) "C-1" Low-Density Commercial District
- iv) "C-2" Medium-Density Commercial District
- v) "OMI" Office Medical Institutional

Table 4.2: Non-Residential/ Transitional Districts	
Previously Established Zoning District	Newly Established Zoning District
C-1	CBD
C-2	C-2
C-N	C-1
G	I-1
H-1	I-2
O-1	OMI
	MXU
	PUD

c) Industrial Districts

- i) "I-1" Light Industrial District
- ii) "I-2" Heavy Industrial District

d) PLANNED UNIT DEVELOPMENT (PUD) DISTRICT

ESTABLISHED. The PUD District is hereby established. This ordinance allows for any zoning district(s) to be rezoned for the creation of a PUD. All PUDs shall be consistent with the requirements of *Chapter VI: Planned Unit Developments*.

**Sec. 4.02 - ZONING DISTRICT TRANSITION**

1) The zoning districts, as established by this ordinance, differ from previously established zoning districts in the City of Dallas Zoning Ordinance dated 1975. Each of the districts has either been combined with other districts, removed, remains the same, or is a newly added district. *Table 4.1: Residential Transitional Districts* and *Table 4.2: Non-Residential/Transitional Districts* shall apply for all district interpretations regarding previously and newly established zoning districts. The New Town Overlay and Corridor Overlay Zones are hereby repealed.

**Sec. 4.03 – PERMITTED AND SPECIAL EXCEPTION USES**

---

- 1) Permitted and Special Exception Use Table
  - a) Within *Table 4.3: Permitted and Special Exception Land Uses*, specific uses located in the left column are designated as either Permitted Uses, Permitted with Conditions, and Permitted by Special Exception (Conditional Use). If there is no designation, the use is not permitted within that district.
  - b) A Development Plan may be required as per *Section 11.03 – Development Plan Review and Approval*.
- 2) USE CLASSIFICATIONS
  - a) Permitted uses. Permitted uses are those uses allowed without special permission of the Dallas City Council, given that they follow the standards and requirements set forth in this ordinance.
  - b) Special Exceptions. Special Exceptions are those uses that, because of potential incompatibility and negative impact on surrounding land uses, require additional review in order to determine compliance with City of Dallas standards and to determine their suitability in a given location. In order to achieve balance between the public benefit and the local impact, Special Exceptions are only permitted following a public hearing and approval by the Planning Commission, as per *Section 2.02 – Planning Commission* and *Section 11.09 – Special Exception Procedure*.
  - c) Unlisted or Questionable Land Uses. Any use listed within *Section 4.03 – Permitted and Special Exception* uses but not designated as either permitted or Special Exception within a specific zoning district on the table shall be not permitted within the specific zoning district. If a use is not listed on the table, the requirements of the most similar use may be imposed according to a determination by the Director. This determination may be appealed to the Zoning Board of Adjustment consistent with the provisions of *Section 11.11 – Administrative Appeals Procedure* for Administrative Appeal Applications.
- 3) USES PERMITTED PER LOT. Only one (1) principal use (whether a permitted or Special Exception use) of a lot shall be permitted. All other uses occurring on a lot shall be accessory to or a subordinate component of the principal use (e.g. a shopping center would be considered the principal use).
- 4) ACCESSORY USES. Accessory uses and structures shall be incidental to, and commonly associated with the operation of, the principal use of the lot. Accessory use standards and requirements are listed in *Sec. 8.02 – Accessory Structure and Use Standards*.

Table 4.3: Permitted and Conditional Land Uses <sup>1</sup>	ZONING DISTRICTS												
	RESIDENTIAL						COMMERCIAL					INDUSTRIAL	
	R-1	R-2	R-3	MF-1	MF-2	TH	CBD	MXU	C-1	C-2	OMI	I-1	I-2
<b>Agricultural</b>													
agricultural chemical sales, distribution & storage	-	-	-	-	-	-	-	-	-	-	-	-	●
farm equipment sales and service	-	-	-	-	-	-	-	-	-	●	-	-	-
farmer's market	-	-	-	-	-	-	Ⓢ	Ⓢ	-	-	-	-	-
winery	-	-	-	-	-	-	-	Ⓢ	●	●	-	-	-
<b>Residential</b>													
bed and breakfast establishments	Ⓢ	Ⓢ	Ⓢ	Ⓢ	Ⓢ	Ⓢ	-	Ⓢ	-	-	-	-	-
boarding house	-	-	-	-	-	-	-	-	-	-	-	-	-
day care home: small (1-6 enrollees)	Ⓢ	Ⓢ	Ⓢ	Ⓢ	Ⓢ	Ⓢ	-	-	-	-	-	-	-
day care home: large (7 or more enrollees)	-	-	-	-	Ⓢ	-	-	Ⓢ	Ⓢ	-	-	-	-
dwelling, accessory apartment	●	●	●	-	-	-	-	-	-	-	-	-	-
dwelling, multi-family <sup>3</sup>	-	-	-	●	●	●	-	Ⓢ	-	-	-	-	-
dwelling, part of mixed-use structure <sup>4</sup>	-	-	-	-	-	-	●	●	-	-	-	-	-
dwelling, single-family	●	●	●	-	-	-	-	-	-	-	-	-	-
dwelling, two-family	-	-	-	●	●	-	-	Ⓢ	-	-	-	-	-
personal care home, family (4-6 residents)	Ⓢ	Ⓢ	-	-	-	-	-	Ⓢ	-	-	-	-	-
personal care home, group (7-16 residents)	Ⓢ	Ⓢ	-	-	-	-	-	Ⓢ	-	-	●	-	-
personal care home, congregate (17+ residents)	-	-	-	-	-	-	-	-	-	-	●	-	-
home business	●	-	-	-	-	-	-	-	-	-	-	-	-
home occupation	●	●	●	●	●	●	-	Ⓢ	-	-	-	-	-
independent living facility for seniors	-	-	-	-	●	-	-	-	-	-	●	-	-
nursing home, assisted living, or retirement facility	-	-	-	Ⓢ	Ⓢ	-	-	-	-	-	●	-	-
<b>Communications/Utilities</b>													
essential services, minor	Ⓢ	Ⓢ	Ⓢ	Ⓢ	Ⓢ	Ⓢ	Ⓢ	●	●	●	●	●	●
essential services, major	Ⓢ	Ⓢ	Ⓢ	Ⓢ	Ⓢ	Ⓢ	Ⓢ	Ⓢ	●	●	●	●	●
solar farms and wind energy conversion systems, noncommercial	-	-	-	-	-	-	-	-	-	-	-	-	Ⓢ
wireless communications facilities	-	-	-	-	-	-	-	-	-	-	-	-	Ⓢ

<sup>1</sup> In addition to permitted uses listed here, any other use that supports the purpose of this Ordinance, as determined by the Community Development Director, is permitted.

<sup>2</sup> Special exception required if outside runs exist

<sup>3</sup> Special Exception required for townhouses, lofts, and condominiums in the MXU District.

<sup>4</sup> Residential units permitted on upper stories only.

Table 4.3: Permitted and Conditional Land Uses <sup>1</sup>	ZONING DISTRICTS												
	RESIDENTIAL						COMMERCIAL					INDUSTRIAL	
	R-1	R-2	R-3	MF-1	MF-2	TH	CBD	MXU	C-1	C-2	OMI	I-1	I-2
<b>Institutional</b>													
educational inst, excluding p-12, public	Ⓢ	Ⓢ	Ⓢ	-	-	Ⓢ	Ⓢ	-	-	●	-	-	-
educational inst, p-12 only, public	Ⓢ	Ⓢ	Ⓢ	-	-	Ⓢ	Ⓢ	-	-	●	-	-	-
educational inst, excluding p-12, private	Ⓢ	Ⓢ	Ⓢ	-	-	Ⓢ	Ⓢ	-	-	●	-	-	-
educational inst, p-12 only, private	Ⓢ	Ⓢ	Ⓢ	-	-	Ⓢ	Ⓢ	-	-	●	-	-	-
animal shelter	-	-	-	-	-	-	-	-	-	-	-	●	-
cemeteries	Ⓢ	Ⓢ	Ⓢ	-	-	Ⓢ	-	●	●	-	-	-	-
clinic	-	-	-	-	-	-	-	●	●	●	●	-	-
community center	Ⓢ	-	Ⓢ	-	-	Ⓢ	-	●	●	●	-	-	-
funeral home / mortuary / crematory	-	-	-	-	-	-	-	Ⓢ	Ⓢ	-	-	-	-
health care facilities, medical and emergency	-	-	-	-	-	-	-	Ⓢ	●	●	●	-	-
lodge or private club	Ⓢ	-	Ⓢ	-	-	Ⓢ	●	●	●	●	-	-	-
places of worship	-	-	Ⓢ	-	-	Ⓢ	-	Ⓢ	Ⓢ	-	-	-	-
publicly-owned buildings and facilities	-	-	Ⓢ	Ⓢ	-	Ⓢ	●	●	●	●	●	●	●
<b>Transportation</b>													
bus/train terminal	-	-	-	-	-	-	Ⓢ	-	-	●	●	-	-
parking lot or structure (as a primary use)	-	-	-	-	-	-	-	-	-	Ⓢ	Ⓢ	-	Ⓢ
<b>Parks &amp; Recreation</b>													
campground/ rv park	-	-	-	-	-	-	-	-	-	-	-	-	-
driving range (as a primary use)	Ⓢ	-	-	-	-	-	-	-	Ⓢ	Ⓢ	-	-	-
golf course	Ⓢ	Ⓢ	-	-	-	-	-	-	-	-	-	-	-
nature preserve	●	●	●	●	●	●	●	●	●	●	●	●	●
recreation (active)	Ⓢ	Ⓢ	Ⓢ	Ⓢ	Ⓢ	Ⓢ	-	-	-	-	-	-	-
recreation (passive)	●	●	●	●	●	●	●	●	-	-	●	-	-

<sup>1</sup> In addition to permitted uses listed here, any other use that supports the purpose of this Ordinance, as determined by the Community Development Director, is permitted.

Table 4.3: Permitted and Conditional Land Uses <sup>1</sup>	ZONING DISTRICTS													
	RESIDENTIAL						COMMERCIAL					INDUSTRIAL		
	R-1	R-2	R-3	MF-1	MF-2	TH	CBD	MXU	C-1	C-2	OMI	I-1	I-2	
● = Permitted Use Ⓢ = Special Exception Required														
<b>Commercial</b>														
<b>Adult Uses</b>														
sexually oriented businesses	-	-	-	-	-	-	-	-	-	-	-	-	-	Ⓢ
<b>Motor Vehicle Services</b>														
car wash	-	-	-	-	-	-	-	-	●	●	-	-	-	-
filling station	-	-	-	-	-	-	-	Ⓢ	●	●	-	●	-	-
impound facility	-	-	-	-	-	-	-	-	-	-	-	Ⓢ	●	-
motor vehicle parts sales (without on-site repair)	-	-	-	-	-	-	-	-	●	●	-	-	-	-
motor vehicle repair and service, major	-	-	-	-	-	-	-	-	Ⓢ	-	-	-	●	-
motor vehicle repair and service, minor	-	-	-	-	-	-	-	-	●	●	-	●	-	-
motor vehicle sales, small	-	-	-	-	-	-	-	-	●	Ⓢ	-	-	-	-
motor vehicle sales, large	-	-	-	-	-	-	-	-	-	●	-	-	-	-
storage, rv and boat	-	-	-	-	-	-	-	-	Ⓢ	-	-	●	-	-
truck stop / travel center	-	-	-	-	-	-	-	-	-	Ⓢ	-	-	-	Ⓢ
<b>Entertainment / Recreation</b>														
banquet or assembly hall	-	-	-	-	-	-	Ⓢ	-	●	●	-	Ⓢ	-	-
conference / convention center	-	-	-	-	-	-	-	-	-	●	●	-	-	-
entertainment, commercial outdoor	-	-	-	-	-	-	-	-	-	-	-	-	-	-
entertainment complex	-	-	-	-	-	-	-	-	Ⓢ	●	-	-	-	-
retreat center	-	-	-	-	-	-	-	-	●	-	●	-	-	-
<b>Services</b>														
commercial services	-	-	-	-	-	-	●	●	●	●	-	-	-	-
day care center (child / adult)	-	-	-	-	Ⓢ	-	-	●	●	●	●	-	-	-
fitness center	-	-	-	-	-	-	●	●	●	●	●	-	-	-
drug stores and pharmacies	-	-	-	-	-	-	●	●	●	●	●	-	-	-
hotels / motels	-	-	-	-	-	-	Ⓢ	Ⓢ	●	●	●	-	-	-
kennel	-	-	-	-	-	-	-	-	Ⓢ	Ⓢ	-	●	-	-
lawncare/landscaping business	-	-	-	-	-	-	-	-	●	-	-	-	-	-
storage, contractor	-	-	-	-	-	-	-	-	Ⓢ	-	-	●	●	-
storage, self-service	-	-	-	-	-	-	-	-	●	●	-	●	-	-
<b>Professional / Office</b>														
administrative/professional office (1 <sup>st</sup> Floor)	-	-	-	-	-	-	-	●	●	●	●	Ⓢ	-	-
administrative/professional office (upper floor)	-	-	-	-	-	-	●	●	●	●	●	Ⓢ	-	-
bank / financial / investment institution	-	-	-	-	-	-	Ⓢ	●	●	●	●	-	-	-
data processing / call center	-	-	-	-	-	-	-	-	●	●	●	-	-	-
medical and dental laboratories	-	-	-	-	-	-	-	-	●	●	●	●	-	-
veterinarian clinics and animal hospitals	-	-	-	-	-	-	-	● <sup>2</sup>	● <sup>2</sup>	●	-	-	-	-

<sup>1</sup> In addition to permitted uses listed here, any other use that supports the purpose of this Ordinance, as determined by the Community Development Director, is permitted.

<sup>2</sup> Special exception required if outside runs exist

Table 4.3: Permitted and Conditional Land Uses <sup>1</sup>	ZONING DISTRICTS												
	RESIDENTIAL						COMMERCIAL					INDUSTRIAL	
	R-1	R-2	R-3	MF-1	MF-2	TH	CBD	MXU	C-1	C-2	OMI	I-1	I-2
<b>Restaurant / Food Preparation</b>													
bar / tavern	-	-	-	-	-	-	●	●	●	●	-	-	-
coffee shop	-	-	-	-	-	-	●	●	●	●	●	Ⓢ	-
microbrewery / brew-pub	-	-	-	-	-	-	●	●	●	●	-	-	-
wine and craft beer boutique	-	-	-	-	-	-	●	●	●	●	-	-	-
restaurants	-	-	-	-	-	-	●	●	●	●	●	Ⓢ	-
restaurants, with drive-thru	-	-	-	-	-	-	-	Ⓢ	●	●	●	Ⓢ	-
<b>Retail</b>													
pawnshop	-	-	-	-	-	-	-	-	-	●	-	-	-
retail small-scale (less than 15,000sf)	-	-	-	-	-	-	●	●	●	●	●	-	-
retail medium-scale (greater than 15,000sf, less than 35,000sf)	-	-	-	-	-	-	-	Ⓢ	●	●	-	-	-
retail large-scale (greater than 35,000sf)	-	-	-	-	-	-	-	-	-	●	-	-	-
<b>Light and Heavy Industrial</b>													
agricultural products terminal	-	-	-	-	-	-	-	-	-	-	-	-	●
animal & animal products processing, packaging	-	-	-	-	-	-	-	-	-	-	-	-	●
auction facility (excluding livestock)	-	-	-	-	-	-	-	-	-	Ⓢ	-	●	-
bottle gas storage & distribution	-	-	-	-	-	-	-	-	Ⓢ	-	-	●	-
composting facility	-	-	-	-	-	-	-	-	-	-	-	-	●
concrete / asphalt production facility	-	-	-	-	-	-	-	-	-	-	-	-	●
explosive manufacturing and storage	-	-	-	-	-	-	-	-	-	-	-	-	●
food & beverage production	-	-	-	-	-	-	-	-	-	-	-	●	●
junk / scrap metal yard	-	-	-	-	-	-	-	-	-	-	-	-	●
lumber yard	-	-	-	-	-	-	-	-	-	-	-	Ⓢ	●
manufacturing (heavy)	-	-	-	-	-	-	-	-	-	-	-	-	●
manufacturing (light)	-	-	-	-	-	-	-	-	-	-	-	●	●
mineral extraction operations <sup>4</sup>	-	-	-	-	-	-	-	-	-	-	-	-	●
petroleum and chemical processing and storage	-	-	-	-	-	-	-	-	-	-	-	-	●
power generation facility (commercial)	-	-	-	-	-	-	-	-	-	-	-	-	●
printing / publishing facility	-	-	-	-	-	-	-	-	-	●	-	●	●
recycling center	-	-	-	-	-	-	-	-	-	-	-	Ⓢ	●
research and testing laboratories	-	-	-	-	-	-	-	-	-	-	-	●	-
salvage yard	-	-	-	-	-	-	-	-	-	-	-	-	Ⓢ
sanitary landfill	-	-	-	-	-	-	-	-	-	-	-	-	Ⓢ
solid waste transfer station	-	-	-	-	-	-	-	-	-	-	-	-	Ⓢ
tool and die shop	-	-	-	-	-	-	-	-	Ⓢ	-	-	●	-
truck freight terminal	-	-	-	-	-	-	-	-	-	-	-	-	●
warehouse & distribution facility	-	-	-	-	-	-	-	-	-	-	-	●	●
waste incinerator	-	-	-	-	-	-	-	-	-	-	-	-	Ⓢ

<sup>1</sup> In addition to permitted uses listed here, any other use that supports the purpose of this Ordinance, as determined by the Community Development Director, is permitted.

<sup>4</sup> In urban areas as defined by O.C.G.A Title 12 - Natural Resources

**THIS PAGE INTENTIONALLY LEFT BLANK**

**Sec. 4.04 – LOT STANDARDS**

---

- 1) Purpose. Lot Standards for each district dictate the minimum and/or maximum standards that apply to lots within certain zoning districts. These regulations for property developed within City of Dallas’s jurisdiction are shown on *Table 4.4: Residential Lot Standards* and *Table 4.5: Non-Residential Lot Standards*.
- 2) Interpreting the Lot Standards Tables. The following explanations of terms should be consulted when interpreting *Table 4.4: Residential Lot Standards* and *Table 4.5: Non-Residential Lot Standards*. For more information on the meaning of terms in this ordinance, see *Chapter XIII: Definitions*.
  - a) Minimum Lot Size. The smallest area established by this ordinance on which a use, structure or building may be located in a particular district and which does not include any street right-of-way.
  - b) Minimum Lot Width. This refers to the minimum width a lot must have in order to be considered developable by this ordinance. The minimum lot width is the minimum allowable horizontal distance between the side property lines of a lot along a straight line parallel to the front lot line at the front setback line. Lot width on cul-de-sac lots and other lots with curving frontages is measured as a line parallel to the frontage and at the front setback line.
  - c) Minimum Lot Frontage. The frontage of a lot shall be construed to be the portion nearest the street. For the purpose of determining setback requirements on corner lots and through lots, all sides of a lot adjacent to streets shall be considered frontages. The minimum length of a lot frontage shall be measured between side lot lines at the street right-of-way or private street easement. Lots that have more than one frontage may combine the width of both frontages to meet the minimum lot frontage standard.
  - d) Maximum Building Height. The maximum allowable vertical distance of a building or structure. Building height shall be defined as the vertical distance as measured from the average elevation of the proposed finished grade at the front of the building to the highest point of the roof for flat roofs, to the deck line of mansard roofs, and the mean height between eaves and ridge for gable, hip and gambrel roofs. Certain height exceptions are permitted according to the provisions of *Section 7.07 – Height Standards*.
    - i) Exceptions to height limits. The height limitations of this chapter shall not apply to church spires, belfries, cupolas and domes not intended for human occupancy, monuments, water towers, observation towers, transmission towers, chimneys, smokestacks, conveyors, flagpoles, masts and aerals.
  - e) Minimum Building Lines.
    - i) The minimum yards (setbacks) for all structures shall be established in *Chapter IV, Table 4.4 and Table 4.5* in the *Dallas Zoning Ordinance* subject to the following requirements:
    - ii) Permitted Encroachments into Yards. The following encroachments shall be allowed to the extent specified below.
    - iii) Non-residential. Canopies and awnings shall be allowed over walkways or driveways to within twelve (12) feet of the street right-of-way or the right-of-way based on the street's functional classification, whichever is farther from the street's centerline. Fuel pumps and pump islands, when permitted, shall be set back as stated in this paragraph for canopies.
    - iv) Single-family residential and townhouses used for single family on individual lots of record. Porches, decks or patios attached to the main dwelling may extend no more than ten feet into

a

- minimum front or rear yard. Outdoor fireplaces and outdoor uncovered kitchens, whether stand alone or constructed as a part of a patio, retaining wall or other structure, may only be located in the rear yard and may extend no more than ten (10) feet into the minimum rear yard. In no case shall an outdoor fireplace be located closer than ten (10) feet to a property line. Awnings may project to within five feet of a side lot line.
- v) All zoning districts. Architectural features such as cornices, eaves, steps, stoops, gutters, fire chases, chimneys which are a part of an exterior wall of the primary structure, and fire escapes may not encroach or project over more than thirty-six (36) inches (3 feet) into any minimum yard. Wheelchair ramps and associated walkways shall be exempt from these requirements.
  - vi) Adjoining railroads. There shall be no minimum rear yard requirement adjoining the siding for those uses which utilize a rail siding for loading and unloading.
  - vii) Building Lot Lines (setbacks).
    - (1) Front Setback. The horizontal space between the Front lot line and the Front Setback line, extending to the side lines of the lot, generally parallel with and measured from the front lot line, defining the area in which no building or structure may be located above ground, except as may be provided in this ordinance. The front setback applies to all frontages of a lot facing a street or right-of-way.
    - (2) Side Setback. The horizontal space between the side lot lines and the side setback lines, extending to the front and rear lot lines, generally parallel with and measured from each side lot line, defining the area in which no building or structure may be located above ground, except as may be provided in this ordinance. However, for corner and through lots, any side of a structure that faces a street shall meet front setback requirements.
    - (3) Rear Setback. The horizontal space between the rear lot line and the rear setback line, extending to the side lines of the lot, generally parallel with and measured from the rear lot line, defining the area in which no building or structure may be located above ground, except as may be provided in this ordinance. For through lots, the rear of the structure facing a street shall meet front setback requirements. Rear setbacks for corner lots will apply to the portion of the lot that is furthest in the opposite direction of the general orientation of the structure.
  - f) Front Setbacks and Roadway Classifications.
    - i) Front Yard Setbacks are intended to establish a visual buffer distinguishing the building line from the roadway. Based on the traffic volume and roadway width, whether in a rural or urban setting, building setbacks are varied according to the road classification, with greater setbacks on larger streets with higher volume traffic, and lesser setbacks on smaller less travelled streets.
    - ii) Roadways are grouped into functional classes according to the character of traffic they are intended to serve. They may also be further classified as rural or urban based on the population surrounding a particular roadway. There are three highway functional classifications: arterial, collector, and local roads, and these can be defined as:
      - (1) Arterial - Provides the next highest level of service at moderate to high speeds, with some degree of access control. Arterials are typically classified as major arterial and minor arterial.
      - (2) Collector - Provides a lower level of service at a lower speed for shorter distances by collecting traffic from local roads and connecting them with arterials. Collectors are also classified as major and minor collectors.

- (3) Local - Consists of all roads not defined as arterials or collectors; primarily provides access to land with little or minimal “through” movement.

Figure 4.1: City of Dallas Roadway Functional Classification

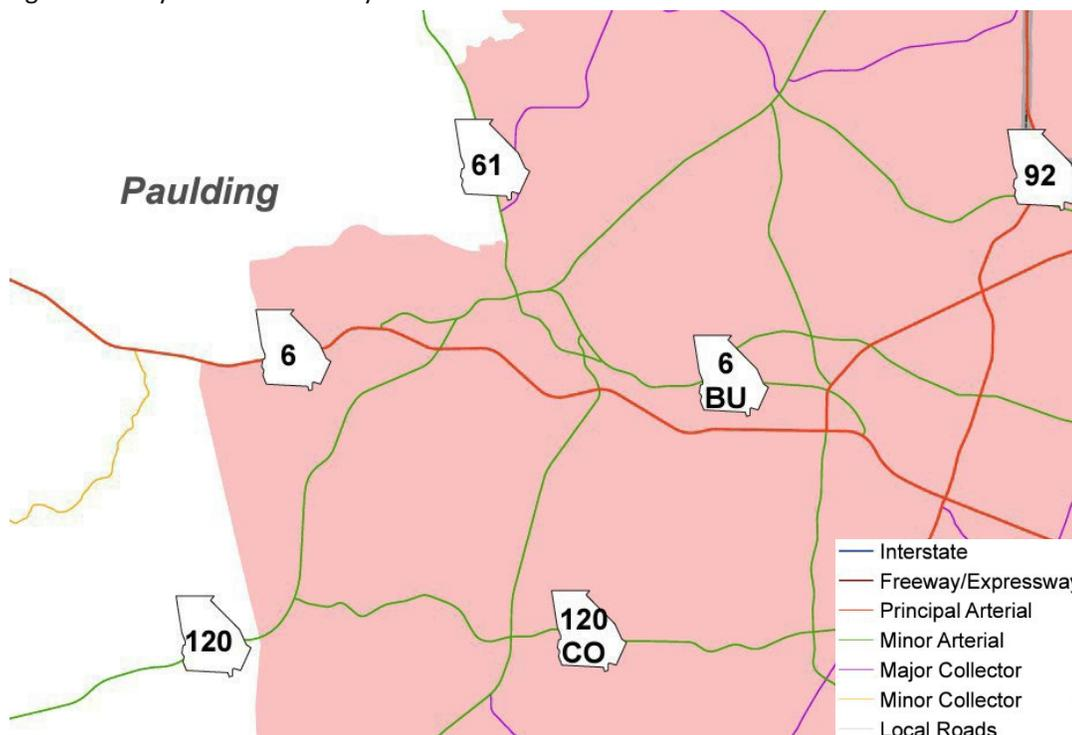

- g) Minimum Distance Between Structures on Same lot. This distance, measured between the points of shortest distance on the exterior facades of two (2) structures, shall determine the minimum separation of multiple structures within one (1) developed lot.
- h) Minimum Ground Floor Living Area (Per unit). The sum of the livable horizontal areas on the ground level of a building measured from the interior faces of the exterior walls, exclusive of basements, unfinished attics and attached garages. The minimum for a specific residential structure shall be dependent on the number of stories within the residential structure.
- i) Total Minimum Living Area (Per unit). The sum of the livable horizontal areas on all levels of a building measured from the interior faces of the exterior walls, exclusive of basements, unfinished attics and attached garages. Each residential dwelling unit shall have separate and individual kitchen and bathroom facilities.
- j) Minimum Living Area Facade Width. The minimum width required for the front facade of a residential structure, exclusive of garages, porches, decks, or terraces. This requirement may apply to a continuous facade for multi-family or single-family attached units.
- k) Maximum Lot Coverage (Structures and Buildings). The maximum amount of enclosed ground floor area of all buildings on a lot expressed as a percentage of the horizontally projected area representing the bulk and mass on the lot.
- l) Maximum Lot Coverage (All Impervious Surfaces). The maximum amount of ground floor area occupied by buildings, structures, parking lots, or other impervious surfaces on a lot expressed as a percentage of the horizontally projected area of the lot

- 3) Lot Standards Table. Lot Standards are listed in the following tables (*Tables 4.4 and 4.5*) under each district heading. Additional development standards including but not limited to parking, sign, and landscaping standards are set forth in *Chapter VII: Development Standards*.

Figure 4.2: Examples of Lot Types

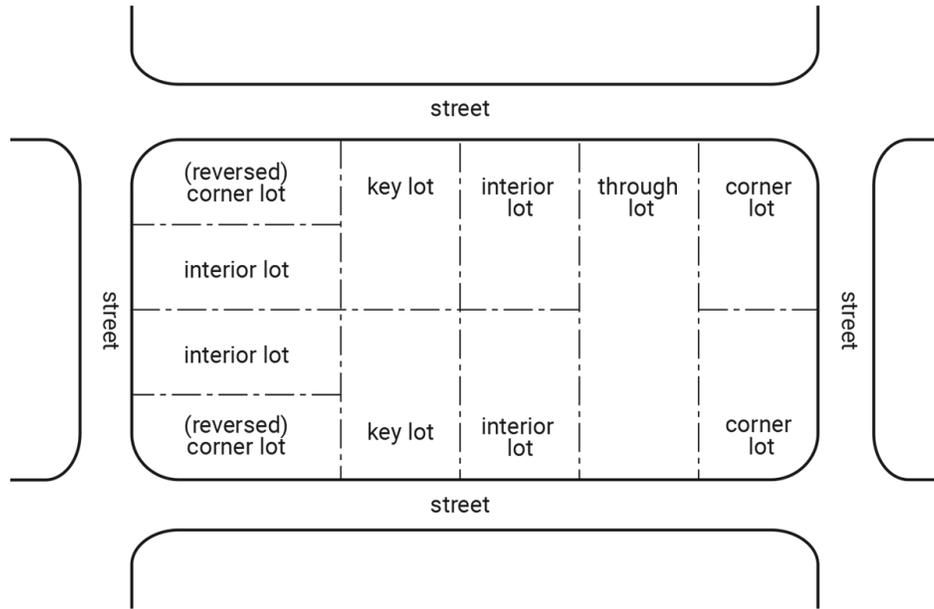
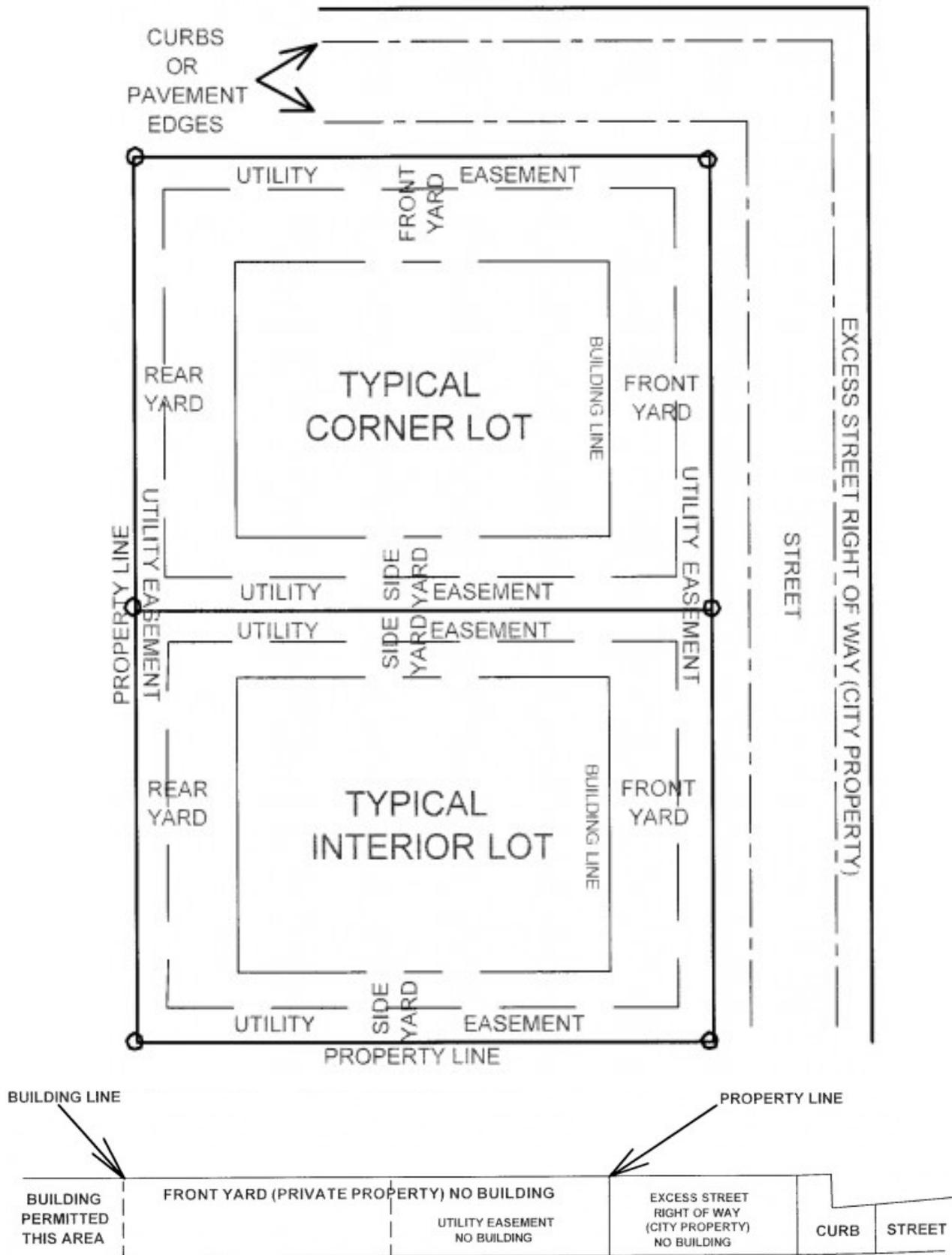

Figure 4.3: Typical Lot Cross Section



**Table 4.4: Residential Lot Standards**

Table 4.4: Residential Lot Standards	Residential											
	R-1 Single-Family Low Density		R-2 Single-Family Medium Density		R-3 Single-Family/High Density		MF-1 Multifamily Low-Density		MF-2 Multifamily Medium- Density		TH Townhome	
	Res	Other	Res	Other	Res	Other	Res	Other	Res	Other	Res	Other
Minimum Lot Size	15,000 sf.	1 ac.	8,500 sf.	1 ac.	6,000 sf.	1 ac.	1 ac.		5 ac.		1 ac.	
Minimum Lot Width	85 ft	100 ft.	50 ft.	100 ft	40 ft.	100 ft.	100 ft.		150 ft.		100 ft.	
Minimum Lot Frontage	50 ft.		50 ft.		40 ft.		50 ft.		50 ft.		50 ft.	
Maximum Building Height <sup>9</sup>	Principal	35 ft.	35 ft.	35 ft.	35 ft.	35 ft.	45 ft.		45 ft.		45 ft.	
	Accessory	24 ft.	24 ft.	24 ft.	24 ft.	24 ft.	24 ft.		24 ft.		24 ft.	
Front Setback <sup>1,10</sup>	35 ft.		25 ft.		25 ft.		30 ft.		30 ft.		25 ft.	
Side Setback <sup>2,3</sup>	Principal	8 ft.	6 ft.	6 ft.	6 ft.	6 ft.	40 ft.		40 ft.		40 ft.	
	Accessory	5 ft./10 ft. <sup>6</sup>	5 ft./10 ft. <sup>6</sup>	5 ft./10 ft. <sup>6</sup>	5 ft./10 ft. <sup>6</sup>	5 ft./10 ft. <sup>6</sup>	10 ft.		10 ft.		10 ft.	
Rear Setback <sup>2</sup>	Principal	15 ft.	15 ft.	15 ft.	15 ft.	15 ft.	40 ft.		40 ft.		40 ft.	
	Accessory	5 ft./10 ft. <sup>6</sup>	5 ft./10 ft. <sup>6</sup>	5 ft./10 ft. <sup>6</sup>	5 ft./10 ft. <sup>6</sup>	5 ft./10 ft. <sup>6</sup>	10 ft.		10 ft.		10 ft.	
Minimum Distance from Structures on Same Lot	5 ft.		5 ft.		5 ft.		20 ft		20 ft.		20 ft.	
Minimum Ground Floor Area (Per Unit)	1 story	1,500 sf.	1,500 sf.	1,500 sf.	1,500/ 1,250 sf.	1,500 sf.	950 sf. Average		950 sf. Average		1,040 sf. Average	
	2+ story	700 sf.	650 sf.	650 sf.	550 sf.	550 sf.	650 sf. avg.		650 sf. avg.		650 sf.	
Total Minimum Living Area (Per Unit)	1,500 sf./ 1,100 sf. <sup>3, 7</sup>		1,500 sf./ 1,100 sf. <sup>3, 7</sup>		1,500 sf./ 1,250 sf. <sup>3, 7</sup>		950 sf. Average		950 sf. Average		1040 sf./ 950 sf.	
Minimum Living Area Façade Width	24 ft.		24 ft.		24 ft.		24 ft.		24 ft.		24 ft.	
Maximum Lot Coverage (structures and buildings)	35% <sup>11</sup> Acc: 5% or 600 sf. (whichever is greater)		40% <sup>11</sup> Acc: 5% or 600 sf. (whichever is greater)		45% <sup>11</sup> Acc: 5% or 600 sf. (whichever is greater)		50% <sup>11</sup> Acc: 5% or 750 sf. (whichever is greater)		75% <sup>11</sup> Acc: 5% or 2,500 sf. (whichever is greater)		50% <sup>11</sup> Acc: 5% or 600 sf. (whichever is greater)	
Maximum Lot Coverage (all impervious surfaces)	50% <sup>12</sup>		50% <sup>12</sup>		50% <sup>12</sup>		50% <sup>12</sup>		75%		50% <sup>12</sup>	

Figure 4.4:  
Residential Zoning Districts and Maximum Densities (Excluding any applicable density bonuses.)

Zoning District	Purpose (Residential Density: Unit: Lot Size)
<b>R-1</b>	Low-Density Single-Family Residential (1:15,000sf)
<b>R-2</b>	Medium Density Single-Family Residential (1:8,500sf)
<b>R-3</b>	High Density Single-Family Residential (1:6,000sf)
<b>MF-1</b>	Multi-Family Residential (1:5,000sf - 1 AC Min Lot)
<b>MF-2</b>	Multi-Family Residential (1:2,250sf - 5 AC Min Lot)
<b>TH</b>	Single-Family Attached (1:2,500sf - 10,000sf Min Lot)
<b>CBD</b>	Central Business District (Over 1st Story Residential 3:1 FAR)
<b>MXU</b>	Mixed Use (2:1 FAR)

**Table 4.5: Non-Residential Lot Standards**

		Commercial				Industrial		
		CBD Central Business District	MXU Commercial Mixed Use	C-1 Commercial Low-Density	C-2 Commercial Medium- Density	OMI Office Medical Institutional	I-1 Industrial Low-Density	I-2 Industrial Medium Density
Minimum Lot Size		N/A	10,000 sf.	0.5 ac.	2.5 ac.	1 ac.	1 ac.	5 ac.
Minimum Lot Width		25 ft.	60 ft.	100 ft.	150 ft.	60 ft.	100 ft.	150 ft.
Minimum Lot Frontage		25 ft.	50 ft.	50 ft.	50 ft.	50 ft.	50 ft.	50 ft.
Maximum Building Height 9	Principal	35 ft.	35 ft.	45 ft.	60 ft.	60 ft.	45 ft.	60 ft.
	Accessory	24 ft.	24 ft.	26 ft.	26 ft.	26 ft.	26 ft.	40 ft.
Front Setback 1, 10, 15		0 ft./15 ft. 14	0 ft./15 ft. 14	30 ft.	35 ft.			
Side Setback 3	Principal	0 ft./5 ft. 13	0 ft./10 ft. 13	10 ft.	30 ft.	30 ft.	40 ft.	50 ft.
	Accessory	5 ft.	10 ft.	10 ft.	10 ft./30 ft. 4	10 ft./30 ft. 4	20 ft./40 ft. 4	30 ft./50 ft. 4
Rear Setback 2	Principal	0 ft./5 ft. 13	20 ft.	20 ft.	45 ft.	45 ft.	50 ft.	75 ft.
	Accessory	5 ft.	5 ft./10 ft. 6	15 ft.	15 ft./45 ft. 6	15 ft./45 ft. 6	20 ft./40 ft. 4	30 ft./50 ft. 4
Projection into setbacks: fire escapes, open stairways, balconies, soffits, canopies, and other similar architectural features may extend up to three (3) feet into a side or rear setback.								
Minimum Distance from Structures on Same Lot		10 ft.	10 ft.	10 ft.	10 ft.	10 ft.	10 ft.	10 ft.
Minimum Ground Floor Area (Per Unit)	1 story	N/A	N/A	N/A	N/A	N/A	N/A	N/A
	2+ story	N/A	N/A	N/A	N/A	N/A	N/A	N/A
Total Minimum Living Area (Per Unit)		750 sf. Avg.	750 sf. Avg.	750 sf. Avg.	N/A	N/A	N/A	N/A
Minimum Living Area Façade Width		N/A	N/A	N/A	N/A	N/A	N/A	N/A
Maximum Lot Coverage (structures and buildings)		N/A	60%	50%	50%	40%	50%	60%
Maximum Lot Coverage (all impervious surfaces)		N/A	75%	75%	80%	60%	75%	80%

- 1) See accessory structure location restrictions *Section 8.02 – Accessory Uses and Structure Standards*
- 2) Check buffer yard standards *Section 7.05 – Landscaping Standards* and/or apply any applicable easement widths
- 3) On corner lots, the side yard setback of the secondary roadway frontage, based on the orientation of the façade with the primary entrance, shall be fifteen (15) feet in single-family residential zoning districts (R-1, R-2, R-3)
- 4) When adjoining the same or a more intense district /when adjoining a less intense district
- 5) For residential uses / all other uses adjoining the same or a more intense district / all other uses when adjoining a less intense district
- 6) Structures 200 sf. or less / structures greater than 200 sf.
- 7) Single-family residential / two-family residential
- 8) Minimum size of multi-tenant development = 5 acres
- 9) See height exemptions per *Section 7.10 – Height Standards*
- 10) The front building setback may be reduced to a minimum of twenty-five (25) feet for single-family residential subdivision streets within major plats, minor plats, and horizontal property regimes
- 11) Permitted non-residential uses shall not exceed 50%
- 12) Permitted non-residential uses shall not exceed 60%
- 13) When attached to another unit, the setback shall be 0 ft. for the shared wall.
- 14) Zero (0) front lot line on attached buildings with same setback.
- 15) The front building setback may be reduced to a minimum of twenty (20) feet along Merchants Drive within the C-1 Zone.

**THIS PAGE INTENTIONALLY LEFT BLANK**

# R-1

		R-1 Single-Family Low Density	
		Res	Other
Minimum Lot Size		15,000 sf.	1 ac.
Minimum Lot Width		85 ft	100 ft.
Minimum Lot Frontage		50 ft.	
Maximum Building Height <sup>9</sup>	Principal	35 ft.	
	Accessory	24 ft.	
Front Setback <sup>1,10</sup>		35'	
Side Setback <sup>2,3</sup>	Principal	8 ft.	
	Accessory	5 ft./10 ft. <sup>6</sup>	
Rear Setback <sup>2</sup>	Principal	15 ft.	
	Accessory	5 ft./10 ft. <sup>6</sup>	
Minimum Distance from Structures on Same Lot		5 ft.	
Minimum Ground Floor Area (Per Unit)	1 story	1,500 sf.	
	2+ story	700 sf.	
Total Minimum Living Area (Per Unit)		1,500 sf./ 1,100 sf. <sup>7</sup>	
Minimum Living Area Façade Width		24 ft.	
Maximum Lot Coverage (structures and buildings)		35% <sup>11</sup> Acc: 5% or 600 sf. (whichever is greater)	
Maximum Lot Coverage (all impervious surfaces)		50% <sup>12</sup>	

## R1 – Single Family Residential

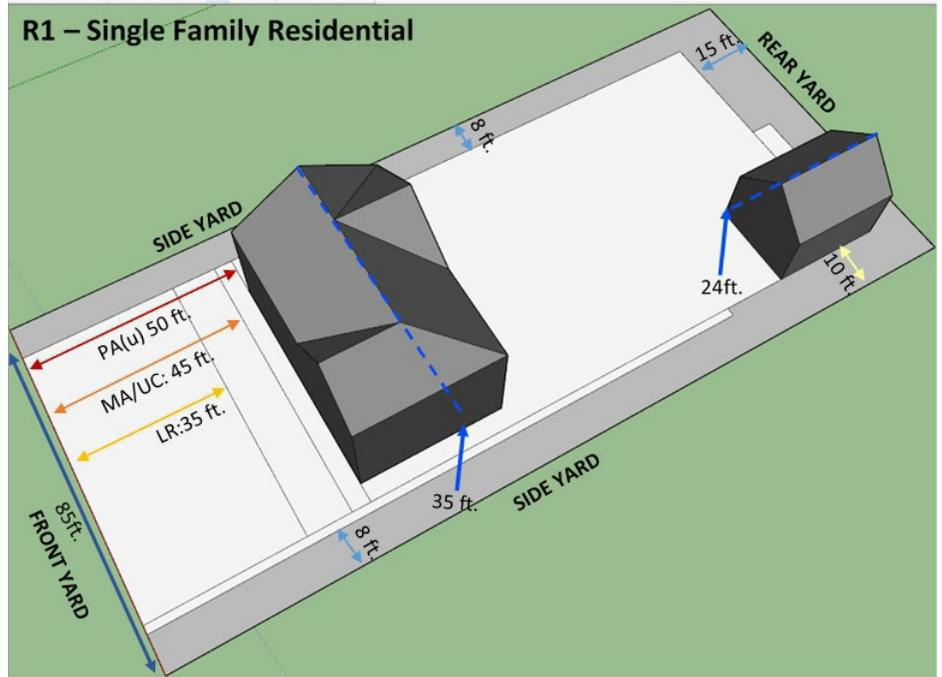

The plan shown does not reflect all requirements contained in this ordinance.



- <sup>1</sup> See accessory structure location restrictions *Section 8.02 – Accessory Uses and Structure Standards*
- <sup>2</sup> Check buffer yard standards *Section 7.05 – Landscaping Standards* and/or apply any applicable easement widths
- <sup>3</sup> On corner lots, the side yard setback of the secondary roadway frontage, based on the orientation of the façade with the primary entrance, shall be fifteen (15) feet in single-family residential zoning
- <sup>6</sup> Structures 200 sf. or less / structures greater than 200 sf.
- <sup>7</sup> Single-family residential / two-family residential (ADU)
- <sup>9</sup> See height exemptions per *Section 7.10 – Height Standards*
- <sup>10</sup> The front building setback may be reduced to a minimum of twenty-five (25) feet for single-family residential subdivision streets within major plats, minor plats, and horizontal property regimes
- <sup>11</sup> Permitted non-residential uses shall not exceed 50%
- <sup>12</sup> Permitted non-residential uses shall not exceed 60%

**District Intent**

The intent of the Single-Family Low Density (R-1) District is to permit the establishment of single-family land uses developed in suburban-style subdivisions. These areas should be located adjacent to existing developed areas and connected to centralized sewer and water facilities. R-1 developments are intended to include pedestrian and community amenities – except for single-lot infill development in existing R-1 zoning districts.

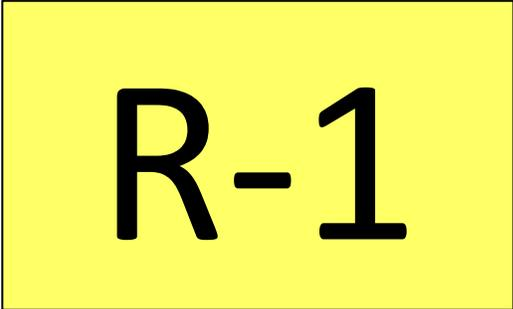

- Special Exception Required**
- 1) Residential
    - a) bed and breakfast
    - b) day care home: small (1-6 enrollees)
    - c) personal care home, family (4-6 residents)
    - d) personal care home, group (7 -16 residents)
    - e) nursing home, assisted living, or retirement facility
  - 2) Communications / Utilities
    - a) essential services, minor
    - b) essential services, major
  - 3) Institutional
    - a) lodge or private club
    - b) educational institution, excluding p-12, public
    - c) educational institution, p-12 only, public
    - d) educational institution, excluding p-12, private
    - e) educational institution, p-12 only, private
    - f) cemeteries
    - g) community center
    - h) lodge or private club
    - i) places of worship
    - j) publicly-owned buildings and facilities
  - 4) Parks & Recreation
    - a) driving range (as a primary use)
    - b) golf course
    - c) recreation (active)

- Permissible Uses**
- 1) Residential
    - a) dwelling, accessory apartment
    - b) dwelling, single-family
    - c) home occupation
    - d) home business
  - 2) Parks & Recreation
    - a) nature preserve
    - b) recreation (passive)



# R-2

		R-2 Single-Family Medium Density	
		Res	Other
Minimum Lot Size		8,500 sf.	1 ac.
Minimum Lot Width		50 ft.	100 ft
Minimum Lot Frontage		50 ft.	
Maximum Building Height <sup>9</sup>	Principal	35 ft.	
	Accessory	24 ft.	
Front Setback <sup>1,10</sup>		25'	
Side Setback <sup>2,3</sup>	Principal	6 ft.	
	Accessory	5 ft./10 ft. <sup>6</sup>	
Rear Setback <sup>2</sup>	Principal	15 ft.	
	Accessory	5 ft./10 ft. <sup>6</sup>	
Minimum Distance from Structures on Same Lot		5 ft.	
Minimum Ground Floor Area (Per Unit)	1 story	1,500 sf.	
	2+ story	650 sf.	
Total Minimum Living Area (Per Unit)		1,500 sf./ 1,100 sf. <sup>3, 7</sup>	
Minimum Living Area Façade Width		24 ft.	
Maximum Lot Coverage (structures and buildings)		40% <sup>11</sup> Acc: 5% or 600 sf. (whichever is greater)	
Maximum Lot Coverage (all impervious surfaces)		50% <sup>12</sup>	

## R2 – Single Family Residential

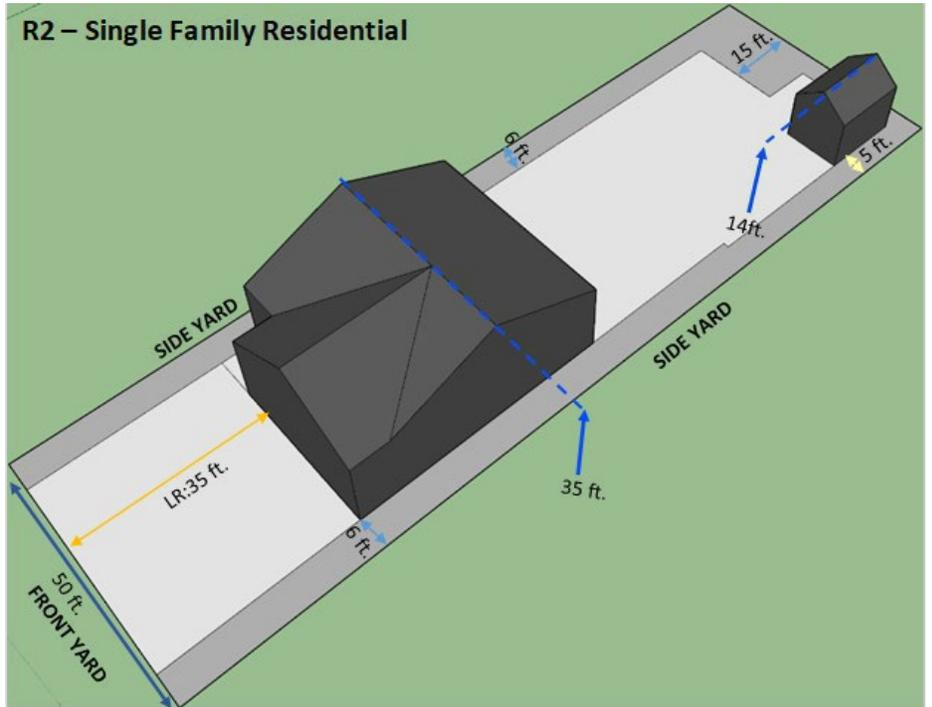

The plan shown does not reflect all requirements contained in this ordinance.



- <sup>1</sup> See accessory structure location restrictions *Section 8.02 – Accessory Uses and Structure Standards*
- <sup>2</sup> Check buffer yard standards *Section 7.05 – Landscaping Standards* and/or apply any applicable easement widths
- <sup>3</sup> On corner lots, the side yard setback of the secondary roadway frontage, based on the orientation of the façade with the primary entrance, shall be fifteen (15) feet in single-family residential zoning
- <sup>6</sup> Structures 200 sf. or less / structures greater than 200 sf.
- <sup>7</sup> Single-family residential / two-family residential (ADU)
- <sup>9</sup> See height exemptions per *Section 7.10 – Height Standards*
- <sup>10</sup> The front building setback may be reduced to a minimum of twenty-five (25) feet for single-family residential subdivision streets within major plats, minor plats, and horizontal property regimes
- <sup>11</sup> Permitted non-residential uses shall not exceed 50%
- <sup>12</sup> Permitted non-residential uses shall not exceed 60%

**District Intent**

The Single-Family Medium Density (R-2) District is intended to provide for moderate density single-family development on smaller lots than are permitted in the R-1 residential district. This district may also accommodate neo-traditional subdivisions and the pattern of development that may occur in the town centers, where a compact urban form with smaller setbacks, and alley access to rear yards and rear-loading garages. This district is designed for areas close to urban development. All lots shall be connected to centralized sewer and water facilities.

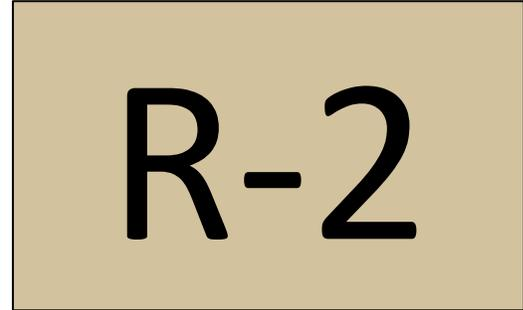

**Special Exception Required**

- 2) Residential
  - a) bed and breakfast
  - b) day care home: small (1-6 enrollees)
  - c) personal care home, family (4-6 residents)
  - d) personal care home, group (7 -16 residents)
- 3) Communications / Utilities
  - a) essential services, minor
  - b) essential services, major
- 4) Institutional
  - a) educational institution, excluding p-12, public
  - b) educational institution, p-12 only, public
  - c) educational institution, excluding p-12, private
  - d) educational institution, p-12 only, private
  - e) cemeteries
  - f) community center
  - g) lodge or private club
  - h) places of worship
  - i) publicly-owned buildings and facilities
- 5) Parks & Recreation
  - a) golf course
  - b) recreation (active)

**Permitted Uses**

- 1) Residential
  - a) dwelling, accessory apartment
  - b) dwelling, single-family
  - c) home occupation
- 2) Parks & Recreation
  - a) nature preserve
  - b) recreation (passive)



# R-3

		R-3 Single-Family High Density	
		Res	Other
Minimum Lot Size		6,000 sf.	1 ac.
Minimum Lot Width		40 ft.	100'
Minimum Lot Frontage		40 ft.	
Maximum Building Height <sup>9</sup>	Principal	35 ft.	
	Accessory	24 ft.	
Front Setback <sup>1,10</sup>		25'	
Side Setback <sup>2</sup>	Principal	6 ft.	
	Accessory	5 ft./10 ft. <sup>7</sup>	
Rear Setback <sup>2</sup>	Principal	15 ft.	
	Accessory	5 ft./10 ft. <sup>7</sup>	
Minimum Distance from Structures on Same Lot		5 ft.	
Minimum Ground Floor Area (Per Unit)	1 story	1,250 sf.	
	2+ story	550 sf.	
Total Minimum Living Area (Per Unit)		1,250 sf./ 1,100 sf. <sup>7</sup>	
Minimum Living Area Façade Width		24 ft.	
Maximum Lot Coverage (structures and buildings)		45% <sup>11</sup> Acc: 5% or 600 sf. (whichever is greater)	
Maximum Lot Coverage (all impervious surfaces)		50% <sup>12</sup>	

## R-3 Single Family Residential

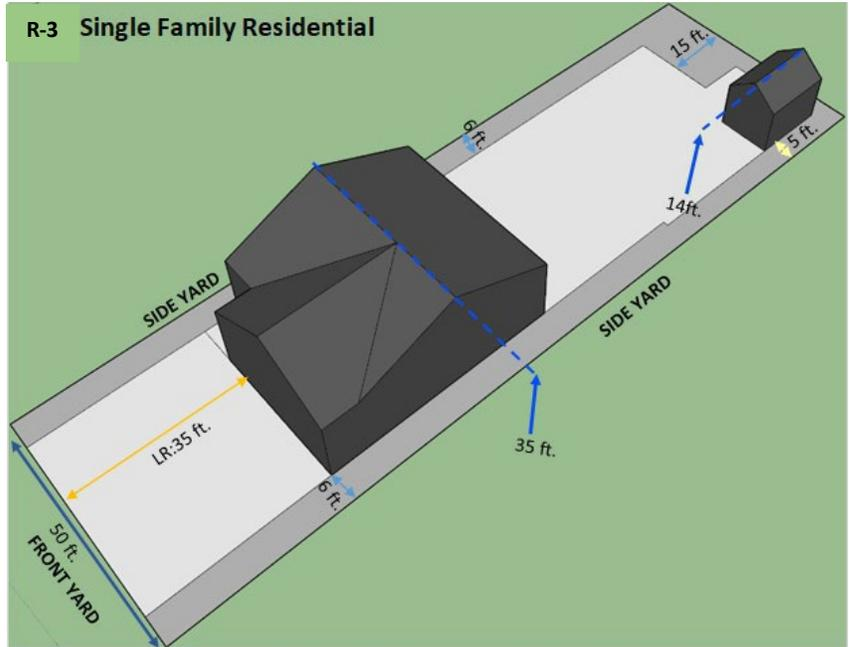

The plan shown does not reflect all requirements contained in this ordinance.



- <sup>1</sup> See accessory structure location restrictions *Section 8.02 – Accessory Uses and Structure Standards*
- <sup>2</sup> Check buffer yard standards *Section 7.05 – Landscaping Standards* and/or apply any applicable easement widths
- <sup>3</sup> On corner lots, the side yard setback of the secondary roadway frontage, based on the orientation of the façade with the primary entrance, shall be fifteen (15) feet in single-family residential zoning
- <sup>6</sup> Structures 200 sf. or less / structures greater than 200 sf.
- <sup>7</sup> Single-family residential / two-family residential (ADU)
- <sup>9</sup> See height exemptions per *Section 7.10 – Height Standards*
- <sup>10</sup> The front building setback may be reduced to a minimum of twenty-five (25) feet for single-family residential subdivision streets within major plats, minor plats, and horizontal property regimes
- <sup>11</sup> Permitted non-residential uses shall not exceed 50%
- <sup>12</sup> Permitted non-residential uses shall not exceed 60%

**District Intent**

The intent of the Single-Family High Density (R-3) District is to maintain and create an environment which meets the community needs for higher quality smaller single-family and single-family dwellings with small accessory apartments (ADU), by reducing the minimum lot sizes, dwelling size and front yard setback. All lots shall be connected to centralized sewer and water facilities and an urbanized roadway network.

# R-3

**Special Exception Required**

- 1) Residential
  - a) bed and breakfast
  - b) day care home: small (1-6 enrollees)
- 2) Communications / Utilities
  - a) essential services, minor
  - b) essential services, major
- 3) Institutional
  - a) educational institution, excluding p-12, public
  - b) educational institution, p-12 only, public
  - c) educational institution, excluding p-12, private
  - d) educational institution, p-12 only, private
  - e) cemeteries
  - f) community center
  - g) lodge or private club
  - h) places of worship
  - i) publicly-owned buildings and facilities
- 4) Parks & Recreation
  - a) recreation (active)

**Permitted Uses**

- 1) Residential
  - a) dwelling, accessory apartment
  - b) dwelling, single-family
  - c) home occupation
- 2) Parks & Recreation
  - a) nature preserve
  - b) recreation (passive)



# MF-1

		MF-1 Multi-Family Low-Density
Minimum Lot Size		1 ac.
Minimum Lot Width		100 ft
Minimum Lot Frontage		50 ft.
Maximum Building Height <sup>9</sup>	Principal	45 ft.
	Accessory	24 ft.
Front Setback <sup>1,10</sup>		30'
Side Setback <sup>2</sup>	Principal	40 ft.
	Accessory	10 ft.
Rear Setback <sup>2</sup>	Principal	40 ft.
	Accessory	10 ft.
Minimum Distance from Structures on Same Lot		20 ft
Minimum Ground Floor Area (Per Unit)	1 story	950 sf. Average
	2+ story	650 sf. avg.
Total Minimum Living Area (Per Unit)		950 sf. Average
Minimum Living Area Façade Width		24 ft.
Maximum Lot Coverage (structures and buildings)		50% <sup>11</sup> Acc: 5% or 750 sf. (whichever is greater)
Maximum Lot Coverage (all impervious surfaces)		50% <sup>12</sup>

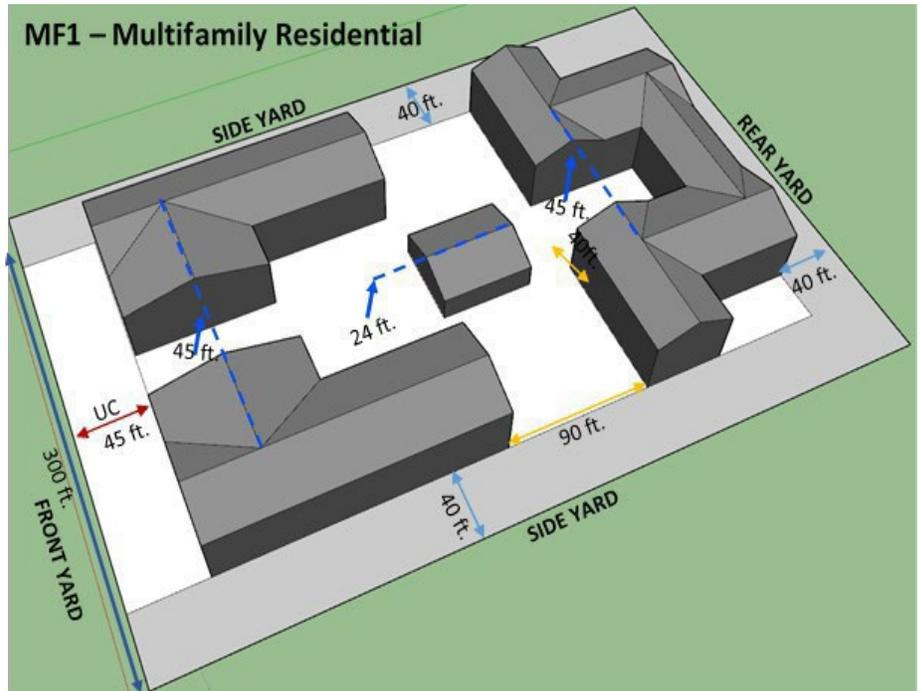

The plan shown does not reflect all requirements contained in this ordinance.



- <sup>1</sup> See accessory structure location restrictions *Section 8.02 – Accessory Uses and Structure Standards*
- <sup>2</sup> Check buffer yard standards *Section 7.05 – Landscaping Standards* and/or apply any applicable easement widths
- <sup>9</sup> See height exemptions per *Section 7.10 – Height Standards*
- <sup>10</sup> The front building setback may be reduced to a minimum of twenty-five (25) feet for single-family residential subdivision streets within major plats, minor plats, and horizontal property regimes
- <sup>11</sup> Permitted non-residential uses shall not exceed 50%
- <sup>12</sup> Permitted non-residential uses shall not exceed 60%

**District Intent**

**Special Exception Required**

- 1) Residential
  - a) bed and breakfast
  - b) day care home, small (1-6 enrollees)
  - c) nursing home, assisted living, or retirement facility
- 2) Communications / Utilities
  - a) essential services, minor
  - b) essential services, major
- 3) Institutional
  - a) publicly-owned buildings and facilities
- 4) Parks & Recreation
  - a) recreation (active)

The Multifamily Residential (MF-1) District is intended to provide areas for lower-density multifamily developments for a variety of housing and ownership types such as duplex/triplex, townhomes, apartment homes, and condominiums. These lower density communities should be located in areas with access to compatible infrastructure (streets and utilities), commercial, and recreational development.



**Permitted Uses**

- 1) Residential
  - a) Dwelling, two-family
  - b) dwelling, multifamily
  - c) home occupation
- 2) Parks & Recreation
  - a) nature preserve
  - b) recreation (passive)



# MF-2

		MF-2 Multifamily Medium-Density
Minimum Lot Size		5 ac.
Minimum Lot Width		150 ft.
Minimum Lot Frontage		50 ft.
Maximum Building Height <sup>9</sup>	Principal	65 ft.
	Accessory	24 ft.
Front Setback <sup>1,10</sup>		30'
Side Setback <sup>2</sup>	Principal	40 ft.
	Accessory	10 ft.
Rear Setback <sup>2</sup>	Principal	40 ft.
	Accessory	10 ft.
Minimum Distance from Structures on Same Lot		20 ft.
Minimum Ground Floor Area (Per Unit)	1 story	950 sf. Average
	2+ story	650 sf. avg.
Total Minimum Living Area (Per Unit)		950 sf. Average
Minimum Living Area Façade Width		24 ft.
Maximum Lot Coverage (structures and buildings)		75% <sup>11</sup> Acc: 5% or 2,500 sf. (whichever is greater)
Maximum Lot Coverage (all impervious surfaces)		75%

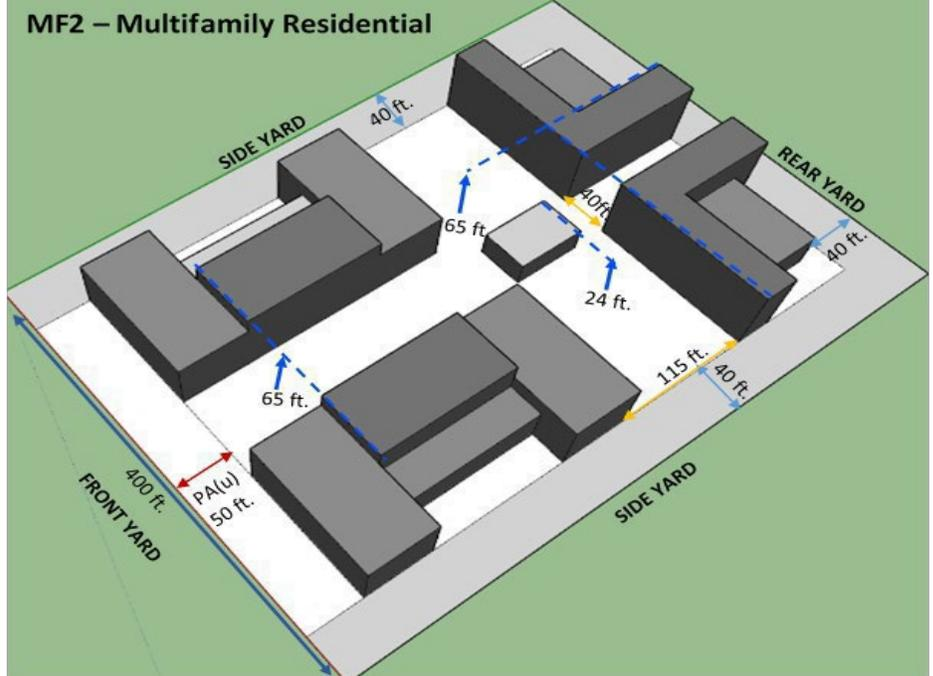

The plan shown does not reflect all requirements contained in this ordinance.



- <sup>1</sup> See accessory structure location restrictions *Section 8.02 – Accessory Uses and Structure Standards*
- <sup>2</sup> Check buffer yard standards *Section 7.05 – Landscaping Standards* and/or apply any applicable easement widths
- <sup>9</sup> See height exemptions per *Section 7.10 – Height Standards*
- <sup>10</sup> The front building setback may be reduced to a minimum of twenty-five (25) feet for single-family residential subdivision streets within major plats, minor plats, and horizontal property regimes
- <sup>11</sup> Permitted non-residential uses shall not exceed 50%

**District Intent**

The Multifamily Residential (MF-2) District is intended to provide areas for medium-density multifamily developments for a variety of housing and ownership types such as apartment homes and condominiums. These higher density communities should be located in areas with access to compatible infrastructure (streets and utilities), commercial, and recreational development.

# MF-2

**Special Exception Required**

- 1) Residential
  - a) bed and breakfast
  - b) day care home, small (1-6 enrollees)
  - c) day care home, large (7 or more enrollees)
  - d) childcare center (adult/child)
  - e) nursing home, assisted living, or retirement facility
- 2) Communications / Utilities
  - a) essential services, minor
  - b) essential services, major
  - c) publicly-owned buildings and facilities
- 3) Parks & Recreation
  - a) recreation (active)

**Permitted Uses**

- 1) Residential
  - a) dwelling, multifamily
  - b) home occupation
- 2) Parks & Recreation
  - a) nature preserve
  - b) recreation (passive)



# TH

		TH Townhome
Minimum Lot Size		1 ac.
Minimum Lot Width		100 ft.
Minimum Lot Frontage		50 ft.
Maximum Building Height <sup>9</sup>	Principal	40 ft.
	Accessory	24 ft.
Front Setback <sup>1,10</sup>		25'
Side Setback <sup>2</sup>	Principal	40 ft.
	Accessory	10 ft.
Rear Setback <sup>2</sup>	Principal	40 ft.
	Accessory	10 ft.
Minimum Distance from Structures on Same Lot		20 ft.
Minimum Ground Floor Area (Per Unit)	1 story	1,040 sf.
	2+ story	650 sf.
Total Minimum Living Area (Per Unit)		1040 sf./ 950 sf.
Minimum Living Area Façade Width		24 ft.
Maximum Lot Coverage (structures and buildings)		50% <sup>11</sup> Acc: 5% or 600 sf. (whichever is greater)
Maximum Lot Coverage (all impervious surfaces)		50% <sup>12</sup>

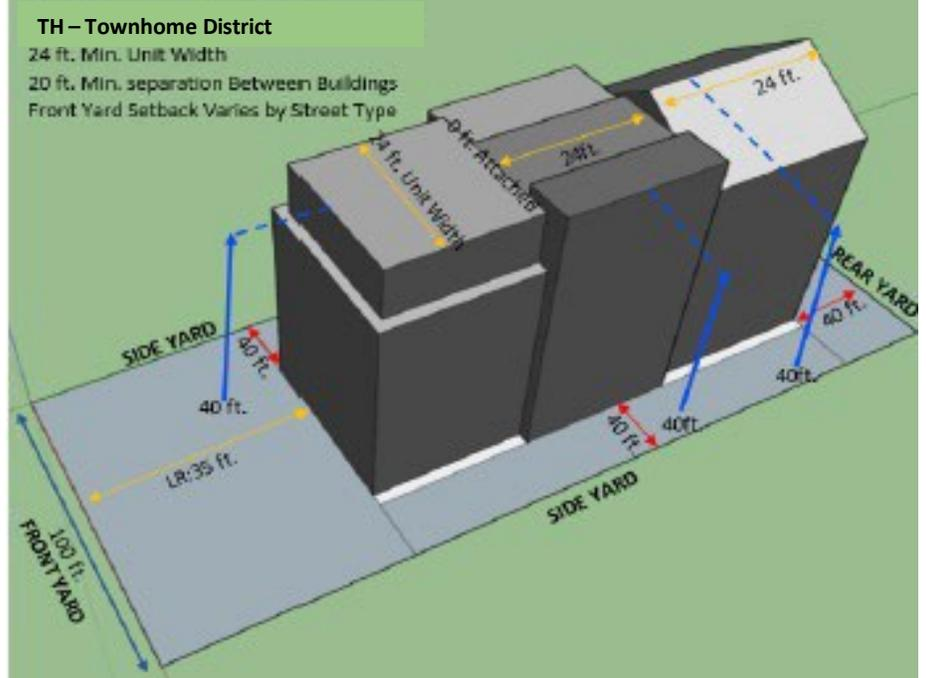

The plan shown does not reflect all requirements contained in this ordinance.



- <sup>1</sup> See accessory structure location restrictions *Section 8.02 – Accessory Uses and Structure Standards*
- <sup>2</sup> Check buffer yard standards *Section 7.05 – Landscaping Standards* and/or apply any applicable easement widths
- <sup>6</sup> Structures 200 sf. or less / structures greater than 200 sf.
- <sup>9</sup> See height exemptions per *Section 7.10 – Height Standards*
- <sup>10</sup> The front building setback may be reduced to a minimum of twenty-five (25) feet for single-family residential subdivision streets within major plats, minor plats, and horizontal property regimes
- <sup>11</sup> Permitted non-residential uses shall not exceed 50%
- <sup>12</sup> Permitted non-residential uses shall not exceed 60%

**District Intent**

The intent of the Townhome (TH) District is to maintain and create an environment which meets the community needs for attached single-family dwellings and single-family dwellings with small accessory apartments (ADU), by restricting other uses within the district and by establishing a minimum lot size. All lots shall be connected to centralized sewer and water facilities and an urbanized roadway network.



**Special Exception Required**

- 1) Residential
  - a) day care home: small (1-6 enrollees)
  - b) nursing home, assisted living, or retirement facility
- 2) Communications / Utilities
  - a) essential services, minor
  - b) essential services, major
- 3) Institutional
  - a) publicly-owned buildings and facilities
- 4) Parks & Recreation
  - a) recreation (active)

**Permitted Uses**

- 1) Residential
  - a) dwelling, multifamily
  - b) dwelling, two-family
  - c) home occupation
- 2) Parks & Recreation
  - a) nature preserve
  - b) recreation (passive)



# CBD

		CBD Central Business District
Minimum Lot Size		N/A
Minimum Lot Width		25 ft.
Minimum Lot Frontage		25 ft.
Maximum Building Height <sup>9</sup>	Principal	35 ft.
	Accessory	24 ft.
Front Setback <sup>1,10</sup>		0 ft./15 ft. <sup>14</sup>
Side Setback <sup>2</sup>	Principal	0 ft./5 ft. <sup>13</sup>
	Accessory	5 ft.
Rear Setback <sup>2</sup>	Principal	0 ft./5 ft. <sup>13</sup>
	Accessory	5 ft.
Minimum Distance from Structures on Same Lot		10 ft.
Minimum Ground Floor Area (Per Unit)	1 story	N/A
	2+ story	N/A
Total Minimum Living Area (Per Unit)		750 sf. Avg.
Minimum Living Area Façade Width		N/A
Maximum Lot Coverage (structures and buildings)		N/A
Maximum Lot Coverage (all impervious surfaces)		N/A

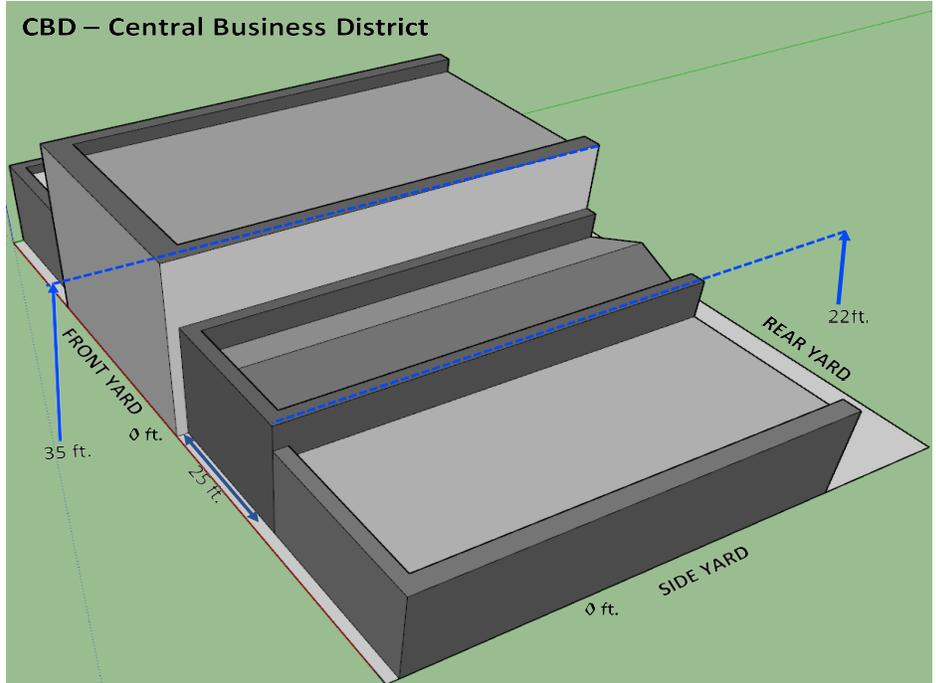

The plan shown does not reflect all requirements contained in this ordinance.



- <sup>1</sup> See accessory structure location restrictions *Section 8.02 – Accessory Uses and Structure Standards*
- <sup>2</sup> Check buffer yard standards *Section 7.05 – Landscaping Standards* and/or apply any applicable easement widths
- <sup>9</sup> See height exemptions per *Section 7.10 – Height Standards*
- <sup>11</sup> Permitted non-residential uses shall not exceed 50%
- <sup>13</sup> When attached to another unit, the setback shall be 0 ft. for the shared wall.
- <sup>14</sup> Zero (0) front lot line on attached buildings with same setback.

**District Intent**

The intent of the Central Business District (CBD) is to provide a commercial core to the downtown that allows a wide range of retail, service, municipal and tourism-related uses that includes residential uses that do not occupy street level, street fronting space. The high volume of pedestrian movement generated within this district will be facilitated as much as possible by the separation of pedestrian and vehicular traffic.

- Special Exception Required**
- 1) Agricultural
    - a) farmers market
  - 2) Communications / Utilities
    - a) essential services, minor
    - b) essential services, major
  - 3) Institutional
    - a) bus/train terminal
    - b) educational institution, excluding p-12, public
    - c) educational institution, p-12 only, public
    - d) educational institution, excluding p-12, private
    - e) educational institution, p-12 only, private
  - 4) Commercial
    - a) banquet or assembly hall
    - b) hotel/motel
    - c) bank/financial/investment institution



- Permitted Uses**
- 1) Residential
    - a) dwelling, part of mixed-use structure
  - 2) Institutional
    - a) lodge or private club
    - b) publicly-owned buildings and facilities
  - 3) Parks & Recreation
    - a) nature preserve
    - b) recreation (passive)
  - 4) Commercial
    - a) commercial services
    - b) fitness center
    - c) drug stores and pharmacies
    - d) administrative/professional office (upper floors only)
    - e) bar/tavern
    - f) coffee shop
    - g) microbrewery/brew-pub
    - h) wine and craft beer boutiques
    - i) restaurants
    - j) retail, small scale (less than 15,000 sf.)



<h1>MXU</h1>		
		<b>MXU</b> Mixed Use
Minimum Lot Size		10,000 sf.
Minimum Lot Width		60 ft
Minimum Lot Frontage		50 ft.
Maximum Building Height <sup>9</sup>	Principal	35 ft.
	Accessory	24 ft.
Front Setback <sup>1,10</sup>		0 ft./15 ft. <sup>14</sup>
Side Setback <sup>2</sup>	Principal	0 ft./10 ft. <sup>13</sup>
	Accessory	10 ft.
Rear Setback <sup>2</sup>	Principal	20 ft.
	Accessory	5 ft./10 ft. <sup>6</sup>
Minimum Distance from Structures on Same Lot		10 ft.
Minimum Ground Floor Area (Per Unit)	1 story	N/A
	2+ story	N/A
Total Minimum Living Area (Per Unit)		750 sf. Avg.
Minimum Living Area Façade Width		N/A
Maximum Lot Coverage (structures and buildings)		60%
Maximum Lot Coverage (all impervious surfaces)		75%

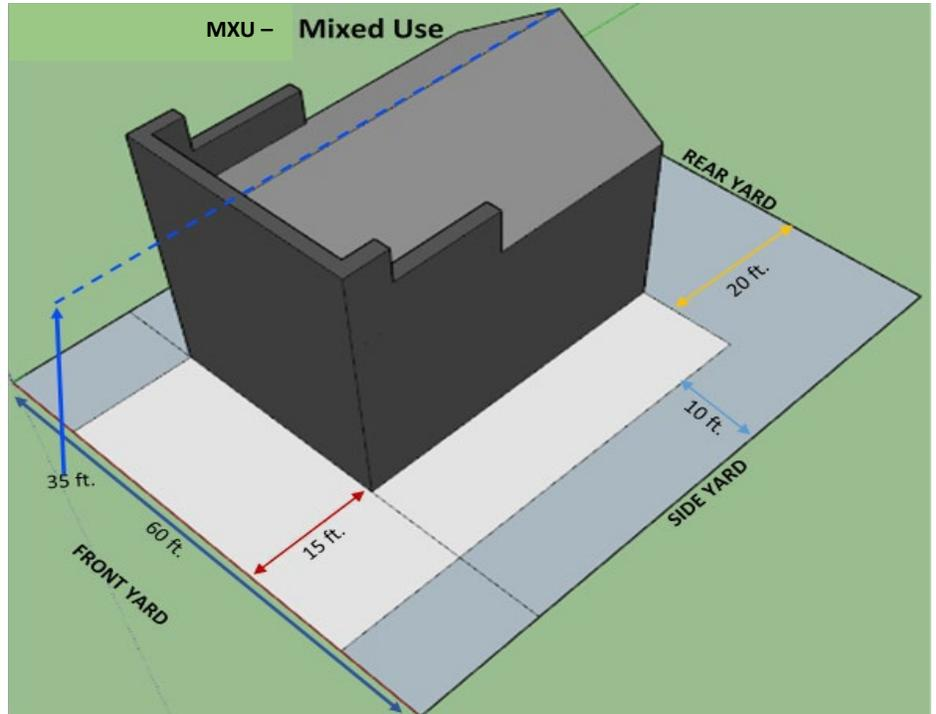

The plan shown does not reflect all requirements contained in this ordinance.



- <sup>1</sup> See accessory structure location restrictions *Section 8.02 – Accessory Uses and Structure Standards*
- <sup>2</sup> Check buffer yard standards *Section 7.05 – Landscaping Standards* and/or apply any applicable easement widths
- <sup>6</sup> Structures 200 sf. or less / structures greater than 200 sf.
- <sup>9</sup> See height exemptions per *Section 7.10 – Height Standards*
- <sup>13</sup> When attached to another unit, the setback shall be 0 ft. for the shared wall.
- <sup>14</sup> Zero (0) front lot line on attached buildings with same setback.

**District Intent**

The purpose of the Mixed-Use (MXU) District is to encourage the development of a range of convenience retail uses, personal, professional and business services required to meet the needs of the immediate neighborhood. This district could permit mixed-use development. This district should be protected from non-neighborhood serving land uses such as “big box” retail uses or other non-compatible commercial or industrial uses.

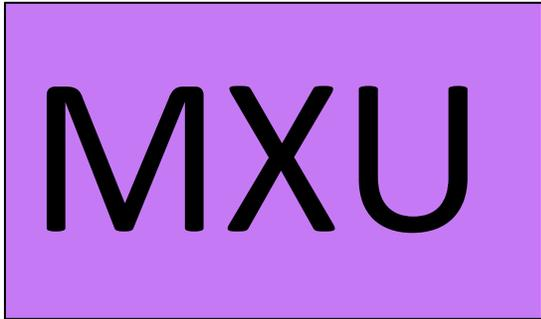

- Special Exception Required**
- 1) Agricultural
    - a) farmers market
    - b) winery
  - 2) Residential
    - a) apartments, townhouses, lofts, and condominiums
    - b) bed and breakfast establishments
    - c) daycare home, large (7 or more enrollees)
    - d) dwelling, two-family
    - e) personal care home, family (4-6 residents)
    - f) personal care home, group (7-16 residents)
    - g) home occupation
  - 3) Communications / Utilities
    - a) essential services, major
  - 4) Institutional
    - a) bus/train terminal
    - b) funeral home/mortuary/crematory
    - c) healthcare facilities, medical and emergency
    - d) places of worship
  - 5) Commercial
    - a) filling station
    - b) hotels/motels
    - c) restaurant, with drive-thru
    - d) retail, medium scale (greater than 15,000sf, less than 30,000sf)

- Permitted Uses**
- 1) Residential
    - a) dwelling, part of mixed-use structure
  - 2) Communications / Utilities
    - a) essential services, minor
  - 3) Institutional
    - a) cemeteries
    - b) clinics
    - c) community center
    - d) lodge or private club
    - e) publicly-owned buildings and facilities
  - 4) Parks & Recreation
    - a) nature preserve
    - b) recreation (passive)
  - 5) Commercial
    - a) commercial services
    - b) day care (child/adult)
    - c) fitness center
    - d) drug stores and pharmacies
    - e) administrative/professional office (1<sup>st</sup> and/or upper floor)
    - f) bank/financial/investment institution
    - g) veterinarian clinic/animal hospital
    - h) bar/tavern
    - i) coffee shop
    - j) microbrewery/brew-pub
    - k) wine and craft beer boutiques
    - l) restaurants
    - m) retail, small scale (less than 15,000 sf.)



C-1		
		<b>C1</b> Commercial Low-Density
Minimum Lot Size		1 ac.
Minimum Lot Width		100 ft.
Minimum Lot Frontage		50 ft.
Maximum Building Height <sup>9</sup>	Principal	45 ft.
	Accessory	26 ft.
Front Setback <sup>1,10,15</sup>		30 ft.
Side Setback <sup>2</sup>	Principal	10 ft.
	Accessory	10 ft.
Rear Setback <sup>2</sup>	Principal	20 ft.
	Accessory	15 ft.
Minimum Distance from Structures on Same Lot		10 ft.
Minimum Ground Floor Area (Per Unit)	1 story	N/A
	2+ story	N/A
Total Minimum Living Area (Per Unit)		750 sf. Avg.
Minimum Living Area Façade Width		N/A
Maximum Lot Coverage (structures and buildings)		50%
Maximum Lot Coverage (all impervious surfaces)		75%

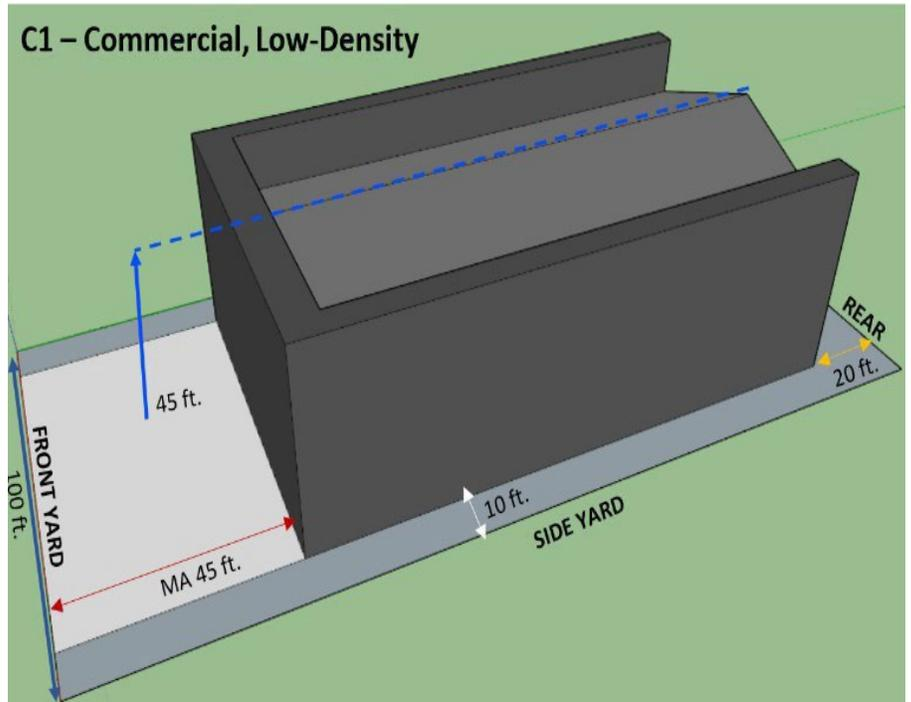

The plan shown does not reflect all requirements contained in this ordinance.



- <sup>1</sup> See accessory structure location restrictions *Section 8.02 – Accessory Uses and Structure Standards*
- <sup>2</sup> Check buffer yard standards *Section 7.05 – Landscaping Standards* and/or apply any applicable easement widths
- <sup>9</sup> See height exemptions per *Section 7.10 – Height Standards*
- <sup>10</sup> The front building setback may be reduced to a minimum of twenty-five (20) feet along Merchants Drive.
- <sup>15</sup> The front building setback may be reduced to a minimum of twenty (20) feet along Merchants Drive within the C-1 Zone.

**District Intent**

The purpose of the Commercial, Low-Density (C1) District is to encourage well-planned commercial uses (retail, service, office, personal and professional services) on visually prominent and high use corridors to meet the needs of a community market area. These developments should provide unified design, safe ingress and egress, adequate and properly located parking and service facilities and convenient and safe pedestrian

# C-1

**Special Exception Required**

- 1) Residential
  - a) daycare home: large (7 or more enrollees)
- 2) Communications / Utilities
  - a) essential services, major
- 3) Institutional
  - a) funeral home/mortuary/crematory
  - b) places of worship
- 4) Commercial
  - a) motor vehicle repair and service, major
  - b) storage, rv and boat
  - c) entertainment complex
  - d) storage, contractor
  - e) kennel, inside runs
- 5) Light and Heavy Industrial
  - a) bottle gas storage & distribution
  - b) tool & die shop
- 6) Parks & Recreation
  - a) driving range (as a primary use)

**Permitted Uses**

- 1) Agricultural
  - a) winery
- 2) Communications / Utilities
  - a) essential services, minor
  - b) essential services, major
- 3) Institutional
  - a) cemeteries
  - b) clinic
  - c) community center
  - d) healthcare facilities, medical and emergency
  - e) lodge or private club
  - f) publicly owned buildings or facilities
- 4) Parks & Recreation
  - a) golf course
  - b) nature preserve

**Permitted Uses (Cont.)**

- 5) Commercial
  - a) car wash
  - b) filing station
  - c) motor vehicle parts sales (without on-site repair)
  - d) motor vehicle repair and service, minor
  - e) motor vehicle sales, small
  - f) banquet or assembly hall
  - g) retreat center
  - h) commercial services
  - i) daycare center (child/ adult)
  - j) fitness center
  - k) drug stores and pharmacies
  - l) hotels/motels
  - m) Pet groomers
  - n) lawncare/landscape business
  - o) storage, self-service
  - p) administrative/professional office (1<sup>st</sup> and/or upper floor)
  - q) bank/financial/investment institution
  - r) data processing/call center
  - s) medical/dental laboratories
  - t) veterinarian clinic and animal hospitals
  - u) bar/tavern
  - v) coffee shop
  - j) microbrewery/brew-pub
  - k) wine and craft beer boutiques
  - v) restaurants
  - w) restaurants, with drive-thru
  - x) retail, small scale (less than 15,000 sf.)
  - y) retail, medium-scale (greater than 15,000 sf, less than 35,000 sf)

# C-2

		C2 Commercial Medium-Density
Minimum Lot Size		2.5 ac.
Minimum Lot Width		150 ft.
Minimum Lot Frontage		50 ft.
Maximum Building Height <sup>9</sup>	Principal	60 ft.
	Accessory	26 ft.
Front Setback <sup>1,10</sup>		35 ft.
Side Setback <sup>2</sup>	Principal	30 ft.
	Accessory	10 ft./30 ft. <sup>4</sup>
Rear Setback <sup>2</sup>	Principal	45 ft.
	Accessory	15 ft./45 ft. <sup>6</sup>
Minimum Distance from Structures on Same Lot		10 ft.
Minimum Ground Floor Area (Per Unit)	1 story	N/A
	2+ story	N/A
Total Minimum Living Area (Per Unit)		N/A
Minimum Living Area Façade Width		N/A
Maximum Lot Coverage (structures and buildings)		50%
Maximum Lot Coverage (all impervious surfaces)		80%

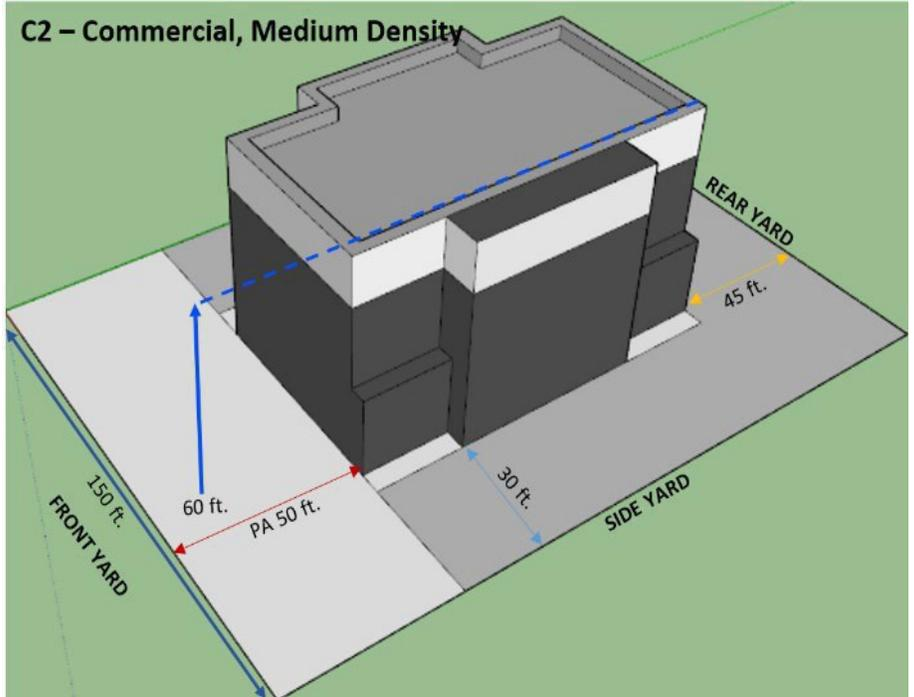

The plan shown does not reflect all requirements contained in this ordinance.



- <sup>1</sup> See accessory structure location restrictions *Section 8.02 – Accessory Uses and Structure Standards*
- <sup>2</sup> Check buffer yard standards *Section 7.05 – Landscaping Standards* and/or apply any applicable easement widths
- <sup>4</sup> When adjoining the same or a more intense district /when adjoining a less intense district
- <sup>6</sup> Structures 200 sf. or less / structures greater than 200 sf.
- <sup>9</sup> See height exemptions per *Section 7.10 – Height Standards*

**District Intent**

The intent of the Commercial, Medium-Density (C2) District is to encourage the establishment of business and institutional uses that serve a regional market and require convenient access to high-volume transportation routes such as interstate highways or major arterial. In addition to the permitted uses identified in C1, C2 includes:

- Special Exception Required**
- 1) Commercial
    - a) motor vehicle sales, small
    - b) truck stop/travel center
    - c) parking lot or structure (as a primary use)
  - 2) Light and Heavy Industrial
    - a) Auction facility (excluding livestock)
  - 3) Parks & Recreation
    - a) driving range (as a primary use)

- Permitted Uses**
- 1) Agricultural
    - a) farm equipment sales and service
    - b) winery
  - 2) Communications / Utilities
    - a) essential services, minor
    - b) essential services, major
  - 3) Institutional
    - a) educational institution, excluding p-12, public
    - b) educational institution, p-12 only, public
    - c) educational institution, excluding p-12, private
    - d) educational institution, p-12 only, private
    - e) bus/train terminal
    - f) clinic
    - g) community center
    - h) healthcare facilities, medical and emergency
    - i) lodge or private club
    - j) publicly owned buildings or facilities
  - 4) Parks & Recreation
    - a) nature preserve

- Permitted Uses (Cont.)**
- 5) Commercial
    - a) car wash
    - b) filling station
    - c) motor vehicle parts sales (without on-site repair)
    - d) motor vehicle repair and service, minor
    - e) motor vehicle sales, large
    - f) banquet or assembly hall
    - g) conference/convention center
    - h) entertainment complex
    - i) commercial services
    - j) daycare center (child/ adult)
    - k) fitness center
    - l) drug stores and pharmacies
    - m) motels/hotels
    - n) kennel, inside runs/groomers
    - o) storage, self-service
    - p) administrative/professional office (1<sup>st</sup> and/or upper floors)
    - q) bank/financial/ investment institution
    - r) data processing/call center
    - s) medical/dental laboratories
    - t) veterinarian clinics and animal hospitals
    - u) bar/tavern
    - v) coffee shop
    - w) microbrewery/brew-pub
    - x) wine and craft beer boutique
    - y) restaurants
    - z) restaurants, with drive-thru
    - aa) retail, small scale (less than 15,000 sf.)
    - bb) retail, medium-scale (greater than 15,000 sf, less than 35,000 sf)
    - dd) retail, large-scale, (greater than 35,000sf)

# OMI

		OMI Office Medical Institutional
Minimum Lot Size		1 ac.
Minimum Lot Width		60 ft
Minimum Lot Frontage		50 ft.
Maximum Building Height <sup>9</sup>	Principal	60 ft.
	Accessory	26 ft.
Front Setback <sup>1,10</sup>		35 ft.
Side Setback <sup>2</sup>	Principal	30 ft.
	Accessory	10 ft./30 ft. <sup>4</sup>
Rear Setback <sup>2</sup>	Principal	45 ft.
	Accessory	15 ft./45 ft. <sup>6</sup>
Minimum Distance from Structures on Same Lot		10 ft.
Minimum Ground Floor Area (Per Unit)	1 story	N/A
	2+ story	N/A
Total Minimum Living Area (Per Unit)		N/A
Minimum Living Area Façade Width		N/A
Maximum Lot Coverage (structures and buildings)		40%
Maximum Lot Coverage (all impervious surfaces)		60%

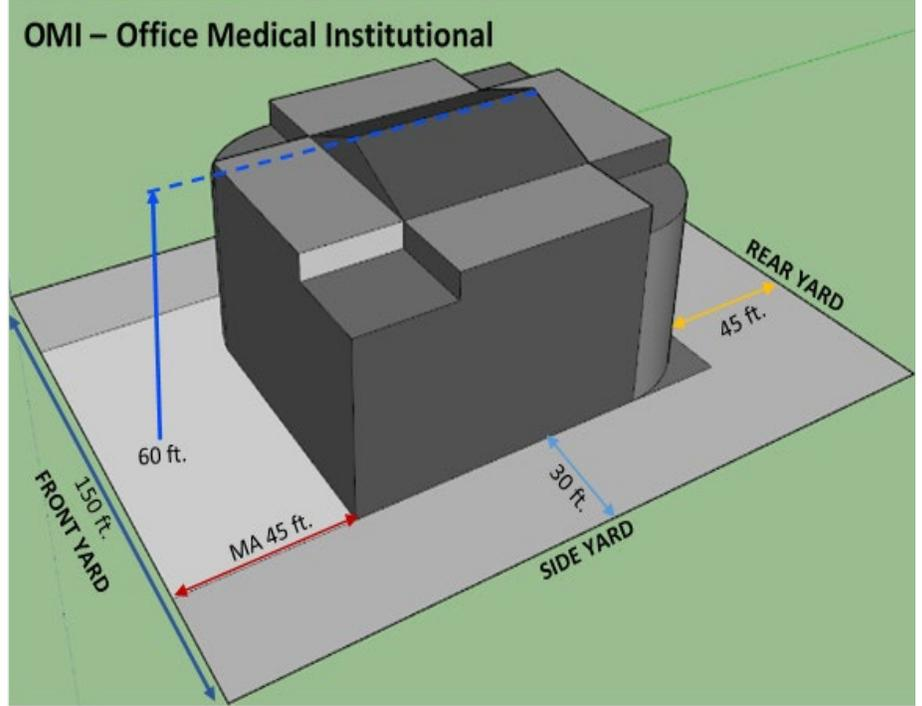

The plan shown does not reflect all requirements contained in this ordinance.



- <sup>1</sup> See accessory structure location restrictions *Section 8.02 – Accessory Uses and Structure Standards*
- <sup>2</sup> Check buffer yard standards *Section 7.05 – Landscaping Standards* and/or apply any applicable easement widths
- <sup>4</sup> When adjoining the same or a more intense district /when adjoining a less intense district
- <sup>6</sup> Structures 200 sf. or less / structures greater than 200 sf.
- <sup>9</sup> See height exemptions per *Section 7.10 – Height Standards*
- <sup>10</sup> The front building setback may be reduced to a minimum of twenty-five (25) feet for single-family residential subdivision streets within major plats, minor plats, and horizontal property regimes

**District Intent**

The purpose of the Office Medical Institutional (OMI) District is to encourage the establishment of campus-style areas for professional offices and services, non-retail in nature, including research facilities, testing laboratories, and administrative facilities that are office-like in physical appearance and service requirements. The district may also provide limited service and retail uses to meet the needs of the district’s employees. The OMI district layout should encourage well-planned office communities with cohesive design elements, vehicular and pedestrian access, and parking facilities. This district can be used as a transitional use or buffer between commercial and more intense industrial uses.

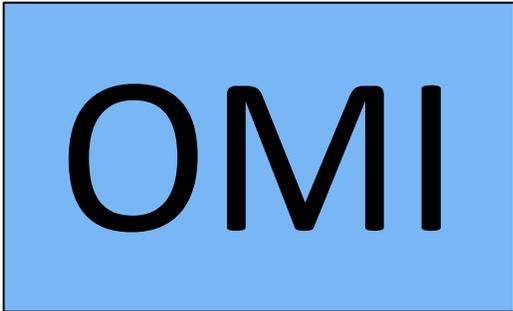

**Permitted Uses (Cont.)**

- 5) Commercial
  - a) conference/convention center
  - b) retreat center
  - c) daycare center (child/ adult)
  - d) fitness center
  - e) drug stores and pharmacies
  - f) hotels/motels
  - g) conference/convention center
  - h) retreat center
  - i) daycare center (child/ adult)
  - j) fitness center
  - k) hotels/motels
  - l) administrative/professional office (1<sup>st</sup> and/or upper floor)
  - m) bank/financial/investment institution
  - n) data processing/call center
  - o) medical and dental laboratories
  - p) coffee shop
  - q) restaurants
  - r) restaurants, fast food
  - s) retail, small scale (less than 15,000 sf.)
- 6) Light and Heavy Industrial
  - a) printing/publishing facility
  - b) research and testing laboratories

**Special Exception Required**

- 1) Transportation
  - a) parking lot or structure (as a primary use)

**Permitted Uses**

- 1) Residential
  - a) Personal care home, group (7-16 residents)
  - b) Personal care home, congregate (17+ residents)
  - c) nursing home, assisted living, or retirement facility
  - d) independent living facility for seniors
  - e) multifamily residential, for elderly and/or disabled
- 2) Communications / Utilities
  - a) essential services, minor
  - b) essential services, major
- 3) Institutional
  - a) bus/train terminal
  - b) clinic
  - c) community center
  - d) healthcare facilities, medical and emergency
  - e) publicly owned buildings and facilities
- 4) Parks & Recreation
  - a) nature preserve

# I-1

		I-1 Industrial Low-Density
Minimum Lot Size		1 ac.
Minimum Lot Width		100 ft.
Minimum Lot Frontage		50 ft.
Maximum Building Height <sup>9</sup>	Principal	45 ft.
	Accessory	26 ft.
Front Setback <sup>1,10</sup>		35 ft.
Side Setback <sup>2</sup>	Principal	40 ft.
	Accessory	20 ft./40 ft. <sup>4</sup>
Rear Setback <sup>2</sup>	Principal	50 ft.
	Accessory	20 ft./40 ft. <sup>4</sup>
Minimum Distance from Structures on Same Lot		10 ft.
Minimum Ground Floor Area (Per Unit)	1 story	N/A
	2+ story	N/A
Total Minimum Living Area (Per Unit)		N/A
Minimum Living Area Façade Width		N/A
Maximum Lot Coverage (structures and buildings)		50%
Maximum Lot Coverage (all impervious surfaces)		75%

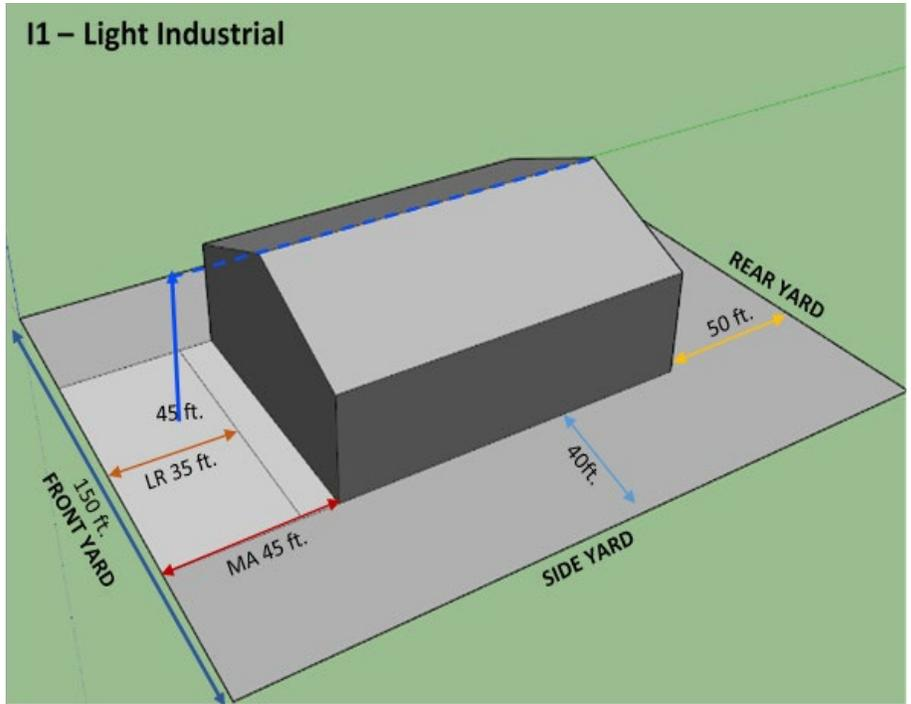

The plan shown does not reflect all requirements contained in this ordinance.



- <sup>1</sup> See accessory structure location restrictions *Section 8.02 – Accessory Uses and Structure Standards*
- <sup>2</sup> Check buffer yard standards *Section 7.05 – Landscaping Standards* and/or apply any applicable easement widths
- <sup>4</sup> When adjoining the same or a more intense district /when adjoining a less intense district
- <sup>9</sup> See height exemptions per *Section 7.10 – Height Standards*

**District Intent**

The purpose of the Industrial, Low-Density (I-1) District is to provide locations for production, small-scale manufacturing, assembly, warehousing, research and development facilities, and similar land uses. This district is intended to accommodate only industrial uses that do not involve the release of potential environmental pollutants or other objectionable elements such as noise, odor, dust, smoke, glare or traffic. This district is designed as a transitional use between heavy manufacturing uses and other less intense business uses.

**Special Exception Required**

- 1) Commercial
  - a) impound facility
  - b) banquet hall or assembly hall
  - c) administrative/professional office (1<sup>st</sup> and/or upper floor)
  - d) coffee shop
  - e) restaurants
  - f) restaurants, fast food
- 2) Light and Heavy Industrial
  - a) lumber yard
  - b) recycling center



I-1

**Permitted Uses**

- 1) Communications / Utilities
  - a) essential services, minor
  - b) essential services, major
- 2) Institutional
  - a) animal shelter
  - b) publicly owned buildings and facilities
- 3) Parks & Recreation
  - a) nature preserve
- 4) Commercial
  - a) filling station
  - b) motor vehicle repair and service, minor
  - c) storage, RV and boat
  - d) kennel/groomer
  - e) storage, contractor
  - f) storage, self-service
  - g) medical and dental laboratories
- 5) Light and Heavy Industrial
  - a) auction facility (excluding livestock)
  - b) bottle gas storage & distribution
  - c) food & beverage production
  - d) manufacturing (light)
  - e) printing/publishing facility
  - f) research and testing laboratories
  - g) tool and die shop
  - h) warehouse and distribution facility

# I-2

		I-2 Industrial Medium-Density
Minimum Lot Size		5 ac.
Minimum Lot Width		150 ft.
Minimum Lot Frontage		50 ft.
Maximum Building Height <sup>9</sup>	Principal	60 ft.
	Accessory	40 ft.
Front Setback <sup>1,10</sup>		35 ft.
Side Setback <sup>2</sup>	Principal	50 ft.
	Accessory	30 ft./50 ft. <sup>4</sup>
Rear Setback <sup>2</sup>	Principal	75 ft.
	Accessory	30 ft./50 ft. <sup>4</sup>
Minimum Distance from Structures on Same Lot		10 ft.
Minimum Ground Floor Area (Per Unit)	1 story	N/A
	2+ story	N/A
Total Minimum Living Area (Per Unit)		N/A
Minimum Living Area Façade Width		N/A
Maximum Lot Coverage (structures and buildings)		60%
Maximum Lot Coverage (all impervious surfaces)		80%

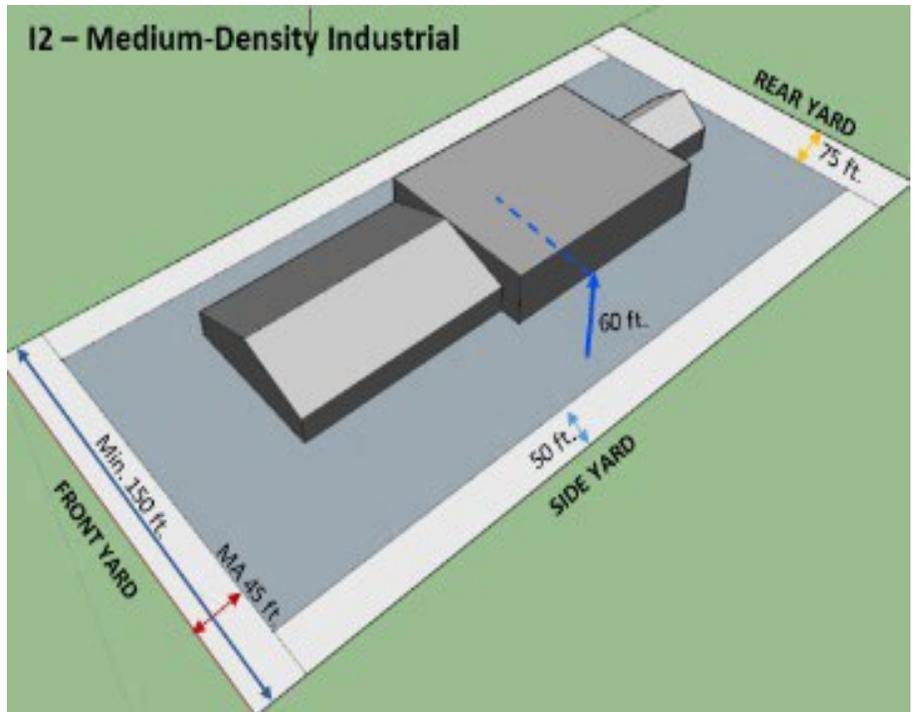

The plan shown does not reflect all requirements contained in this ordinance.



- <sup>1</sup> See accessory structure location restrictions *Section 8.02 – Accessory Uses and Structure Standards*
- <sup>2</sup> Check buffer yard standards *Section 7.05 – Landscaping Standards* and/or apply any applicable easement widths
- <sup>4</sup> When adjoining the same or a more intense district /when adjoining a less intense district
- <sup>9</sup> See height exemptions per *Section 7.10 – Height Standards*

**District Intent**

The purpose of the Industrial, Medium-Density (I-2) District is to encourage the development of manufacturing and wholesale business establishments accommodating a broad range of heavier industrial activities diverse in products, operational techniques and size, which are in locations and under conditions that minimize land, use conflicts. The I-2 district is intended to be located in areas with good access to major thoroughfares and where large shipping truck traffic does not disrupt local streets. In addition to the permitted uses in I-1, I-2 includes:

**Special Exception Required**

- 1) Communications/Utilities
  - a) Solar farms and wind energy conversion systems, noncommercial
  - b) wireless communications facilities
- 2) Transportation
  - a) parking lot or structure (as a primary use)
- 3) Commercial
  - a) sexually oriented businesses
  - b) truck stop / travel center
- 4) Light and Heavy Industrial
  - a) composting facility
  - b) explosive manufacturing and storage
  - c) junk/scrap metal yard
  - d) mineral extraction operations
  - e) salvage yard
  - f) sanitary landfill
  - g) solid waste transfer station
  - h) waste incinerator

# I-2

**Permitted Uses**

- 1) Agricultural
  - a) agricultural chemical sales, distribution & storage
- 2) Communications / Utilities
  - a) essential services, minor
  - b) essential services, major
- 3) Institutional
  - a) publicly owned buildings and facilities
- 4) Parks & Recreation
  - a) nature preserve
- 5) Commercial
  - a) impound facility
  - b) motor vehicle repair and service, major
  - c) storage, contractor
- 6) Light and Heavy Industrial
  - a) agricultural products terminal
  - b) animal & animal products processing, packaging
  - c) concrete/asphalt production facility
  - d) food & beverage production
  - e) lumber yard
  - f) manufacturing (heavy)
  - g) manufacturing (light)
  - h) Petroleum and chemical processing and storage
  - i) Power generation facility, commercial
  - j) printing/publishing facility
  - k) recycling center
  - l) truck freight terminal
  - m) warehouse and distribution facility



**THIS PAGE INTENTIONALLY LEFT BLANK**

**CHAPTER V – INFILL DEVELOPMENT STANDARDS****Sec. 5.01 – INFILL DEVELOPMENT STANDARDS**

---

## 1) INTENT

- a) Infill development shall be considered to be new development, redevelopment, or expansion of existing legally conforming uses that occurs in an area where at least sixty-six percent (66%) of all lots on both sides of the same street block as the subject lot have been developed into residential or commercial uses, and where infrastructure is already in place. It is the general intent of this Section to:
  - i) Accommodate growth in Dallas by encouraging and facilitating new development on vacant, bypassed and underutilized land.
  - ii) Accommodate development in older established residential neighborhoods.
  - iii) Encourage efficient use of land and public services in the context of existing communities.
  - iv) Stimulate economic investment and development in older established communities.
  - v) Provide developers and property owners flexibility so that they can achieve high quality design and develop infill projects that strengthen existing communities.
  - vi) Create a high-quality community environment that is enhanced by a balanced compact mix of development and building types that is pedestrian-scaled and, if applicable, transit-oriented.
  - vii) Improve approval certainty for infill development by providing clear development standards.

## 2) GENERAL REQUIREMENTS

- a) A Development Plan, plat, or certified plot plan shall be required for infill/redevelopment where applicable.
- b) The Development Plan / plat shall incorporate the following elements to enhance compatibility with the surrounding community:
  - i) Sidewalks that connect to the adjacent sidewalk system;
  - ii) Public streets that connect to the adjacent street pattern;
  - iii) Preservation of architecturally significant structures whenever feasible; and
  - iv) Setbacks, building envelopes, use and parking compatible with surrounding community.
- c) All new buildings (except accessory structures) shall have the primary entrance oriented to the street or public walkway, with direct, accessible, and convenient pedestrian connections.

## 3) PERMITTED USES. Permitted uses shall be determined by the following subsections:

- a) Residential Areas. Areas that are made up of predominantly residential uses but no longer permit residential uses may fall under the provisions of *Subsection 3.11..*
  - i) One accessory apartment dwelling unit per lot may be allowed in addition to the principal dwelling unit. Accessory apartment dwelling standards can be found in *Section 8.02 – Accessory Use and Structure Standards*.
  - ii) Home occupations and home-based businesses are allowed in accordance with *Section 8.11 – Home-Based Business*.

- b) Commercial and Mixed-Use Areas. Areas that are made up of predominantly commercial or commercial/residential mixed uses may include uses other than what is permitted in the underlying zoning district by right, subject to consistency with uses that are identified as permitted or Special Exception within the Mixed Use (MXU) zoning district, or the Central Business District (CBD).
  - i) Commercial uses may be mixed vertically or horizontally with residential uses. First floor space shall be restricted to non-residential use in areas of predominantly commercial or mixed-use.
  - ii) Mixed-use should be planned for in the context of existing walkable amenities in the neighborhood or set the standard for future redevelopment.
- 4) LOT AND DEVELOPMENT STANDARDS. Density, design, materials, use and scale should reflect local style, heritage and materials unique to those existing in the surrounding area.
  - a) Lot Size. Lot areas shall be dependent on proposed densities, floor area ratios, setbacks, building heights and community compatibility.
    - i) Existing Small Lot Amnesty. A legal lot of record that existed prior to the date of record of this Ordinance, and is being used for infill or redevelopment may use the minimum lot standards that follow.
  - b) Building Height.
    - i) Buildings shall conform to:
      - (1) maximum heights allowed in the zoning district in accordance with *Table 4.4: Residential Lot Standards* or *Table 4.5: Non-Residential Lot Standards*; or
      - (2) a height that is equal to or the average of adjacent building heights.
    - ii) If the proposed building height(s) is greater than the allowed maximum, the proposed building or structure must meet the following criteria for community compatibility:
      - (1) Neighborhood scale
      - (2) Privacy
      - (3) Light and shadow
      - (4) Views
      - (5) Architectural compatibility
  - c) Setbacks. Minimum setbacks shall be:
    - i) as required in the zoning district; or
    - ii) the average of the established front and side setbacks on properties within the block or six-hundred (600) feet on both sides of the lot parallel to its side lot lines.
  - b) Bulk and Scale. Bulk and scale shall be similar to and consistent with the surrounding neighborhood as evaluated by the bulk of buildings adjacent, abutting and surrounding the

proposed development. Larger buildings should be designed to adhere to the existing architectural pattern of the surrounding neighborhood.

- d) **Flexible Standards.** Flexible development standards to reduce lot area, width, setbacks, height, and other standards may be permitted for infill and redevelopment at the discretion of the Director, subject to proof of good cause and benefit to the development and community, to encourage a variety of land uses, and to address difficult sites which incorporate infill and redevelopment or rehabilitation. Building height and coverage may vary so long as the project average height is consistent with the neighborhood scale and architectural rhythm and does not constitute a disruptive condition in the identity of the area as described here or in *Subsection 5.01(5)*.
- 5) **COMPATIBILITY STANDARDS.** Infill and redevelopment should provide exemplary site design, architectural design and high-quality materials that are compatible with, and does not negatively alter the character of, the existing neighborhood. The applicant should refer to *Chapter IX: Design Standards*.
- a) All infill and redevelopment uses shall meet the intent of this chapter and shall be compatible with existing or proposed uses, as identified in the Comprehensive Plan, in the general vicinity of the proposed development. The following requirements shall apply:
- i) **Building Size, Height, Bulk, Mass, Scale.** Similar in height and size or articulated and subdivided into massing that is more or less proportional to other structures in the area, and maintains the existing architectural rhythm.
  - ii) **Building Orientation.** Primary facades and entries face the adjacent street with a connecting walkway that does not require pedestrians to walk through parking lots or across driveways.
  - iii) **Privacy.** Optimize privacy of residents and minimize infringement on the privacy of adjoining land uses by considering the placement of windows and door entrances. Create opportunities for interactions among neighbors in common pedestrian circulation areas of the project.
  - iv) **Building Materials** shall be similar to materials of the surrounding neighborhood or use other characteristics such as scale, form, architectural detailing, etc. to establish compatibility.

Figure 5.1: Infill Scale and Orientation Example

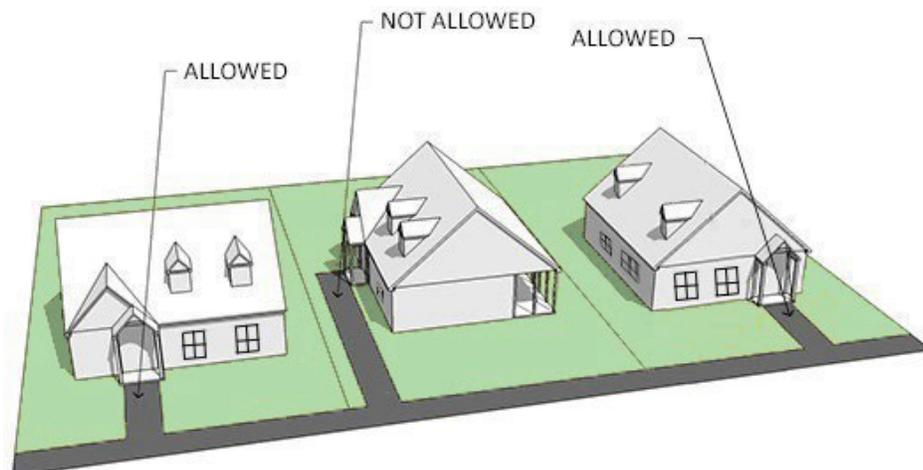

- b) All planned uses, building types, and landscaping shall be included on the Development Plan or plat and shall demonstrate the relationship of the proposed development with existing off-site development in the context of the adjacent community. Compliance with these requirements shall in and of itself be deemed to create a presumption of compatibility.
- 6) OPEN SPACE AND LANDSCAPING. All open space, recreational amenities, and landscaped areas shall meet the requirements of *Section 7.05 – Landscaping Standards* and *Section 7.13 – Open Space Requirements* unless modified per this subsection, and shall be shown on the Development Plan / Plat.
- a) Open Space. Non-residential infill development shall provide common public open space, if planned. An open space credit may be granted if a project is connected to, and located within one-fourth (1/4) mile of, an improved public park or common area by a continuous public sidewalk.
  - b) Landscaping. Natural vegetative features and existing trees shall be incorporated into the site design if practicable. Landscaping, buffering, and other plant material requirements may be reduced at the discretion of the Director. However, the intent of the landscaping to enhance and create a hierarchy of space shall remain. Buffering and screening of incompatible uses shall be maintained.
- 7) PUBLIC FACILITIES AND UTILITIES. Existing and planned public facilities should be shown on the Development Plan / Plat.
- a) All public streets, walkways and alleyways shall be shown on the Development Plan / plat. All through streets and walkways shall be public. The local street and walkway system shall be safe, efficient, convenient, attractive and shall accommodate use by all segments of the population.
    - i) The street and walkway system shall provide multiple, direct and continuous intra- and inter-neighborhood connections between destinations.
    - ii) The street network shall include sidewalks on both sides of the street.
- 8) PARKING. Flexibility for the number of parking spaces required by *Section 7.02 – Off-Street Parking and Loading* may be considered if the project is pedestrian-oriented and serviced within six-hundred (600) feet by public parking.
- a) The parking plan may provide a combination of off-street and on-street spaces. On-street parking is encouraged.
  - b) Shared parking is encouraged and shall comply with *Subsection 7.02(20)*.
  - c) As is practicable, at-grade off-street parking areas should be located at the rear of dwellings in mixed-use or residential areas, with alley access.
  - d) Bicycle spaces shall be provided per *Subsection 7.02(22)*.
  - e) Infill development on properties zoned CBD shall be exempt from *Section 7.02 – Off-Street Parking and Loading Requirements*.

**Sec. 5.02 – INFILL COMPATIBILITY EXAMPLES**

- 1) **HEIGHT.** Buildings in town centers or established neighborhoods share a similar height. Infill construction should respect this. A new facade that is too high or low can interrupt this consistent quality.

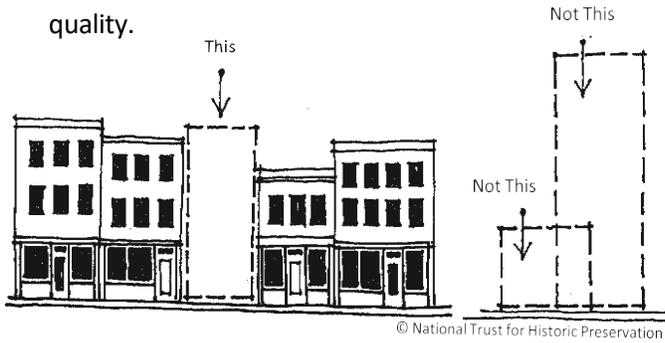

- 2) **PROPORTION.** The characteristic proportion (the relationship between height and width) of existing facades should be respected.

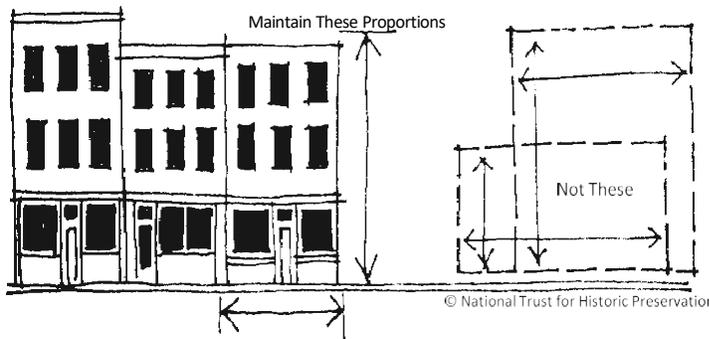

- 3) **RELATIONSHIP TO STREET.** The new facade’s relationship to the street (setback) should be consistent with that of its neighboring buildings.

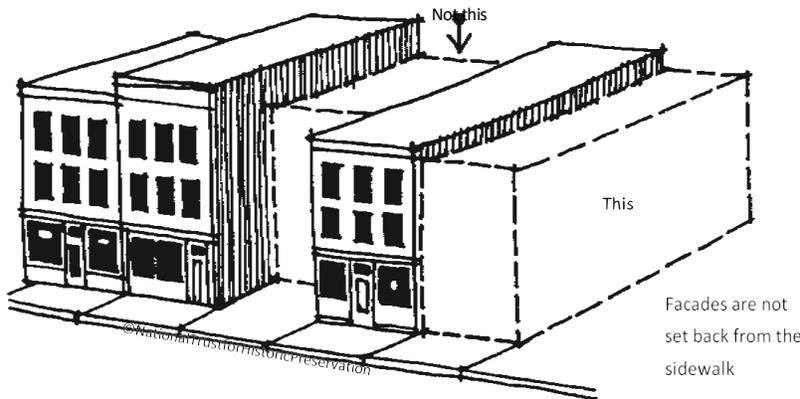

- 4) **RESIDENTIAL NEIGHBORHOOD COMPATIBILITY.** Infill development should be compatible with the established character of the existing neighborhood by utilizing a similar setback and building orientation.

**THIS PAGE INTENTIONALLY LEFT BLANK**

**Sec. 6.01 – PURPOSE**

---

- 1) This chapter is intended to permit the creation of Planned Unit Development (PUD) Districts in accordance with Georgia Code. PUD districts are intended for a parcel of land planned as a single unit which allows for mixed uses and mixed densities under one zoning classification. This Ordinance allows any zoning district to be rezoned for the creation of a PUD district. PUD Districts create neighborhoods that can benefit from innovations in community development, provide greater efficiency in public utilities and services, and preserve open space. All Planned Unit Developments shall be served by centralized sewer and water.

**Sec. 6.02 – PUD USES AND STANDARDS**

---

- 1) USES. All land use classifications that are allowed in this Ordinance may be permitted within a PUD, unless otherwise omitted. All uses are subject to the discretion and approval of the City Council. Once uses are approved by the Council, they are granted by right. All land uses proposed in a Planned Unit Development must be compatible with the intent of the Comprehensive Plan and the characteristics of surrounding land uses and zoning districts.
- 2) STANDARDS. The development and design standards established in this Ordinance shall apply unless alternate development or design standards are proposed by the petitioner. The alternate development standards deemed appropriate by the Planning & Zoning Commission and City Council in order to accomplish the intent of the Planned Unit Development shall be specified in the PUD District Ordinance that is certified by the Planning & Zoning Commission and adopted by the City Council. Any lessening of the required development and design standards of this Ordinance or applicable design guideline documents shall be directly linked to the intent of the Planned Unit Development to:
  - a) Provide a mixed-use development; or
  - b) Provide a creative and unique design; or
  - c) Address unusual physical conditions on site.

**Sec. 6.03 – PROCEDURE SUMMARY**

---

- 1) The section establishes procedures for the review, approval and development of a Planned Unit Development District. There are four basic steps in the PUD process which are illustrated in sequence in the flow charts on the following pages and which are described below:
  - a) Pre-Submittal Conference. The applicant is encouraged to engage in informal consultations with the Dallas Community Development staff prior to preparing plans. The purpose of this meeting is to discuss expectations, schedule, concept and standards contained herein. It shall be understood that no statement or representations by a member of Staff shall be binding upon either the Council or upon any zoning body.
  - b) PUD District Ordinance and Concept Plan. Providing details to the city of the proposed PUD in the form of a “PUD Booklet” that includes a Concept Plan, elevation drawings, a letter of intent, a PUD Ordinance, and other details as required by the Community Development Director, is the second step in the process for establishing a Planned Unit Development. During this step, the petitioner’s proposed development requirements for the Planned Unit Development are reviewed by the Planning & Zoning Commission and the City Council.

The approved standards are codified in a PUD District Ordinance that has the effect of rezoning the subject property to a Planned Unit Development zoning district, and establishing the development requirements that will be applied in all subsequent reviews. A Concept Plan, sample elevations and a letter of intent which accompanies the ordinance provides the Planning & Zoning Commission and City Council with a general vision for the development of the site. The PUD Booklet shall be required to furnish appropriate detail for open space, amenities, densities, number of units, square footage of commercial space, street layout, height, architectural details and other information as requested.

- c) Preliminary Plat. The Detailed Development Plan is the third step in the process. In this step, the applicant prepares an overall plan for the site which will be reviewed by staff, the Technical Advisory Committee. For a Planned Unit Development that is going to be subdivided, this step also serves as the Preliminary Plat.
- d) Final Plat. The Final Plat is the final step in establishing a Planned Unit Development. During this step, the petitioner's specific plan for the entire site or a portion of the site is reviewed by the members of the Technical Advisory Committee. For a Planned Unit Development that is going to be subdivided, this step also serves as the Final Plat.
  - i) Options.
    - (1) Submission of a Preliminary Plat, processed in the manner described in this Chapter, and the subsequent submission of a Final Plat for any portion of the approved Preliminary Plat the applicant wishes to develop. The Final Plat submitted according to this option shall be processed in the manner described in this Chapter.
    - (2) Submission of a Final Plat without a Preliminary Plat, processed in the manner described in this Chapter.

#### Sec. 6.04 – PRE-SUBMITTAL CONFERENCE

- 1) Prior to submitting a Planned Unit Development application, the petitioner shall meet with the Dallas Community Development staff to review the zoning classification of the site, review the regulatory ordinances and materials, review the procedures and examine the proposed use and development of the property. Department staff shall aid and advise the applicant in preparing the application and supportive documents as necessary.

#### Sec. 6.05 – PUD DISTRICT ORDINANCE AND CONCEPT PLAN

- 1) ORIGINATION OF PROPOSALS. Any applicant may propose a Planned Unit Development district in accordance with the procedures established in this chapter. The applicant shall submit an application and fee for a Planned Unit Development in accordance with this section, *Section 6.03 – Procedure Summary*, and the established procedure of the Community Development department. The applicant shall refer to the application packet to determine the format and number of copies of the plans to be delivered.
- 2) AREA REQUIREMENTS. The minimum land area required for a Planned Unit Development shall be five (5) acres. However, a development of less than five (5) acres may be considered by the Planning & Zoning Commission for infill projects.
- 3) PROJECT OWNERSHIP. The project may be owned, leased, or controlled either by a single person or

corporation, or by a group of individuals, or homeowner’s association. Such ownership may be a public or private corporation. However, if not under single ownership, the multiple owners must have a contractual agreement (1) not to develop the parcels separately, but in accordance with a single, unified plan, and (2) in which the separate owners have given their express intentions to enter into such private agreements and to assure its completion as planned and to the satisfaction of the Planning & Zoning Commission. The City Council may grant an extension of such time for such a period as it deems in the public interest.

- 4) DEVELOPMENT STANDARDS. In addition to the applicable provisions of this Ordinance, the PUD Ordinance must comply with the following requirements unless specifically waived by the City Council:
  - a) The Planned Unit Development must be substantially completed within the period of time specified in the schedule of development submitted by the developer.
  - b) The Planned Unit Development will address the public health, safety, and general welfare.
  - c) All uses are subject to the discretion and approval of the City Council.
  - d) The PUD Ordinance shall address the impact on traffic and public services and facilities, such as schools, fire and police protection. A Fiscal Impact Analysis shall be required for developments of one-hundred fifty (150) or more residential units. The Planning & Zoning Commission may also request a Fiscal Impact Analysis or a traffic study for projects under one-hundred fifty (150) units at their discretion. These studies shall address the impact of the proposed Planned Unit Development on all adjacent streets and intersections.
  - e) The PUD Ordinance shall contain such proposed covenants, easements and other provisions relating to the proposed development standards, as reasonably are required for public health, safety and general welfare. A Home Owners Association or other active management is required for all residential developments.
  - f) Gross residential density shall be calculated by dividing the gross acreage of the total development area by the size of the recommended lots to determine total dwelling units per acre in the proposed project.
  - g) Open Space shall be required in accordance with *Section 7.13 –Open Space Requirements*.
  - h) The preliminary and final plat shall be substantially similar to the PUD Booklet and Concept Plan in, number of units, commercial/industrial square footage, street layout, density, and height of structures, parking layout, and pedestrianism pursuant to *Section 6.11 – Amendments to the Concept Plan and Final Plat*.
- 5) PUD BOOKLET REQUIREMENTS
  - a) The PUD Booklet shall address all of the development standards contained within, and may defer to, the City of Dallas Zoning Ordinance. Should the PUD Ordinance not address specific development standards and subsections as set forth within Section 7 and Section 9 of this ordinance, then those standards shall apply. At a minimum, the following requirements should be addressed:

- |  |  |
|--|--|
| i) Location, size, orientation and shape of buildings;     | xii) Minimum lot area;   |
| ii) Building materials and appurtenances;                  | xiii) Minimum lot frontage;                                    |
| iii) Parking;  | xiv) Minimum lot width;  |
| iv) Signage;   | xv) Minimum front setback;                                     |
| v) Exterior renovation or altering of existing structures; | xvi) Minimum side setback;                                     |
| vi) Demolition of existing structures;                     | xvii) Minimum rear setback;                                    |
| vii) Landscaping;  | xviii) Maximum height of structures (principal and accessory); |
| viii) Environmental and natural resource protection;       | xix) Maximum lot coverage;                                     |
| ix) Erosion and sedimentation control;                     | xx) Minimum floor area;  |
| x) Vehicular and pedestrian circulation;                   | xxi) Site access;  |
| xi) Outdoor lighting;                                      | xxii) Site screening and buffering;                            |
|  | xxiii) Location of dumpsters; and                              |
|  | xxiv) Location of open spaces.                                 |

6) REVIEW

- a) The Community Development department shall determine that the PUD District Ordinance and Concept Plan application are a complete submittal. The Department shall:
  - i) Docket Number. Assign the item a docket number;
  - ii) Planning & Zoning Commission. Place the item on an agenda of the Planning & Zoning Commission for public hearing; and
  - iii) Notification. Inform the petitioner of the time, date, and place of the hearing.
  - iv) Record. The Department shall maintain records of all applications, plans, and permits filed for a PUD District Ordinance and Concept Plan.

7) PLANNING & ZONING COMMISSION

- a) Public Notice. The Community Development department shall be responsible for posting public notice pursuant to the Planning & Zoning Commission Rules of Procedure.
- b) Public Hearing. A public hearing shall be held in accordance with the Planning & Zoning Commission Rules of Procedure and the Ordinance draft, concept plan and testimony of the applicant and other attendees shall be considered.
- c) Decision. The Planning & Zoning Commission shall:
  - i) Certify and forward the petition to the City Council with:
    - (1) A favorable recommendation;
    - (2) A negative recommendation;
    - (3) No recommendation; or
    - (4) Continue the petition to a definite future meeting date.

- d) Commitments. In conjunction with its recommendation to the City Council regarding a PUD District Ordinance and Concept Plan, the Planning & Zoning Commission may recommend that the City Council permit the petitioner to make written commitments and may recommend that the Council impose conditions of approval concerning the use or development of the parcel.
  - e) Revisions. Following Planning & Zoning Commission approval, the petitioner shall submit revised copies of the PUD District Ordinance and the Concept Plan that address the comments and concerns of the Planning & Zoning Commission.
- 8) CITY COUNCIL
- a) Decision. The City Council shall:
    - i) Adopt the PUD District Ordinance and Concept Plan;
    - ii) Adopt the PUD District Ordinance and Concept Plan with conditions and/or commitments;
    - iii) Return the PUD District Ordinance and Concept Plan to the Planning & Zoning Commission with proposed amendments; or
    - iv) Deny the PUD District Ordinance and Concept Plan.
  - b) Meaning of Approval. Approval of the PUD District Ordinance by the City Council shall act as a zoning map amendment and an overall guide for the Planned Unit Development, setting forth concepts that shall be consistent in the Preliminary Plat and Final Plat.
  - c) Commitments. The applicant shall prepare the commitment instrument in a form approved by the City Attorney. The petitioner and the Mayor and City Council shall sign the commitment instrument.
- 9) Recording. The petitioner shall record the commitment instrument in the County Recorder's office within thirty (30) days of the approval of the PUD District Ordinance and Concept Plan. The petitioner shall deliver a copy of the recorded commitment instrument to the Community Development department before filing a Preliminary Plat petition. This commitment shall be transferrable per Section 6.12 *Transferability*.
- 10) Modification or Termination. A commitment or conditions of approval made under this section may be modified or terminated only by a decision of the City Council at a public hearing.
- 11) Enforcement. The City may enforce any commitment or condition of approval as if the commitment were a standard of the Dallas Zoning Ordinance.

#### Sec. 6.06 – PRELIMINARY PLAT PROCEDURE

---

- 1) **PURPOSE**. The purpose of a Detailed Development Plan is to divide land into lots, blocks and common area.
- 2) **APPLICATION**. An application for Preliminary Plat shall be filed with the Community Development Director by the owner, or his/her designee, of property for which the Planned Unit Development is proposed. The applicant shall refer to the application packet to determine the format and number of copies of the plans to be delivered and the application shall be in accordance with the established procedures of the Community Development department indicated in Chapter 34 *Subdivisions* of the Dallas Code of Ordinances and shall contain, at a minimum, the following information:
  - a) Name, address, and phone number of applicant;
  - b) Name, address, and phone number of registered surveyor or registered engineer assisting in the

- preparation of the Preliminary Plat;
- c) A survey of the tract that is to be developed;
  - d) Description of existing use;
  - e) Identification of the existing zoning district;
  - f) A vicinity map at a scale approved by the Technical Advisory Committee, showing existing property lines, streets, existing and proposed zoning, and such other items as the Technical Advisory Committee may require to show the relationship of the Planned Unit Development to the Comprehensive Plan and to existing developments, schools and other community facilities and services;
  - g) A Preliminary Plat at a scale approved by the Technical Advisory Committee showing topography at two (2) foot intervals; the approximate location and type of residential, commercial and industrial land uses; layout, dimensions, and names of existing and proposed streets, rights-of-way, utility easements, parks and open spaces; layout and dimensions of lots and building setback lines, areas of proposed buffering; preliminary improvement drawings showing: points of ingress/egress, water, sewer, drainage, electricity, telephone, and such other characteristics as the Technical Advisory Committee deems necessary;
  - h) Proposed schedule for the development of the site, identifying phasing where applicable;
  - i) Evidence that the applicant has sufficient control over the land in question to initiate the proposed development plan within five (5) years; including a statement of all the ownership and beneficial interests in the tract of land and the proposed development;
  - j) In the case of a residential planned unit development, the proposed density to which the Development shall be limited; and
  - k) In the case of office, commercial, industrial, or mixed-use planned unit development, a statement identifying the principal type of office, business, industrial, and/or other uses that are to be included in the proposed development.
- 3) TECHNICAL ADVISORY COMMITTEE. Once the Department has determined that it has received a submittal that is sufficiently complete for Technical Advisory Committee (TAC) review, the Department shall inform the petitioner of the time, date, and place of the meeting. Following TAC review, the applicant shall submit revised copies of the plans that address the comments and concerns of the TAC.
- 4) TECHNICAL ADVISORY COMMITTEE REVIEW AND APPROVAL
- a) After receipt of the Preliminary Plat, the Technical Advisory Committee shall hold a meeting within a reasonable period of time.
  - b) The Technical Advisory Committee shall review the preliminary plan to determine if the Proposed Planned Unit Development is:
    - i) Consistent with the intent and purpose of this Ordinance;
    - ii) Whether the proposed development advances the general welfare of the community and neighborhood; and
    - iii) Whether the benefits, combination of various land uses, and the interrelationship with the land uses in the surrounding area justify the deviation from standard district regulations.
  - c) The Technical Advisory Committee's approval in principle of the primary development shall be necessary before an applicant may submit a Final Plat. Approval in principle shall not be

construed to endorse the following:

- i) A precise location of uses;
  - ii) Configuration of parcels;
  - iii) Engineering feasibility.
- 5) EXPIRATION. The Preliminary Plat approval shall expire in five (5) years unless final approval of all or part of the development is complete.

#### **Sec. 6.07 – FINAL PLAT**

---

- 1) PURPOSE. The purpose of a Final Plat is to provide the details for the construction of individual portions of the PUD. Typical construction plans are submitted and final plats are recorded.
- 2) SUBMISSION. After approval of the Preliminary Plat, the developer shall submit a Final Plat in accordance with established procedures of the Community Development department. The Final Plat shall be in general conformance with the Preliminary Plat as approved by the City Council. The Final Plat shall be certified by a registered engineer or land surveyor.
- 3) APPLICATION. An application for approval of the Final Plat shall be filed with the Community Development Director by all owners, or their designee, of the property for which the Planned Unit Development is proposed. Each application shall be signed by the owner, attesting to the truth and exactness of all information supplied on the application for Final Plat. Approval shall expire and may be revoked if construction on the project has not begun within two (2) years from the date of issuance of the approval and such requirement shall be clearly stated on the application. At a minimum, the application shall contain the following information:
  - a) Any changes necessary to the survey of the proposed development site, showing the dimensions and bearing of the property lines, area in acres, topography, existing features of the development site, including major wooded areas, structures, streets, easements, utility lines and land uses;
  - b) All information required on the Preliminary Plat, the location and sizes of lots, location and proposed density of dwelling units, nonresidential building intensity, and land use considered suitable for adjacent properties;
  - c) A schedule for the development of units to be constructed in progression and a description of the design principles for buildings and streetscapes, tabulation of the number of acres in the proposed project for various uses, the number of housing units proposed by the type, estimated residential population by type housing. Estimated nonresidential population, anticipated timing for each unit, and standards for height, open space, building density, parking areas, population density and public improvements proposed for each unit of the development, whenever the applicant proposes an exception from standard zoning districts or other Ordinances governing development;
  - d) Engineering feasibility studies and plans showing, as necessary, water, sewer, drainage, electricity, and telephone, waste disposal facilities, street improvements, and nature and extent of earth work required for site preparation and development;
  - e) Development plan, showing buildings, various functional use areas, circulation, and their relationship;
  - f) Preliminary building plans, including floor plans and exterior elevations; Landscaping plans;
  - g) When a Planned Unit Development is to be constructed in stages or units, a schedule for the development of such stages or units shall be submitted. When a Planned Unit Development provides for common open space, the total area of common open space provided at any stage

of development shall, at a minimum, bear the same relationship to the total open space to be provided in the entire Planned Unit Development as the stages or units completed or under development bear to the entire Planned Unit Development;

- h) When a Planned Unit Development includes provisions for common open space or recreational facilities, a statement describing the provision that shall be made for the care and maintenance of such open space or recreational facilities. If it is proposed that such open space be owned and/or maintained by any entity other than a governmental authority, copies of the proposed Chapters of incorporation and bylaws of such entity shall be submitted;
  - i) Deed restrictions, and restrictive/protective covenants, and other legal statements or devices to be used to control the use, development and maintenance of the land, and the improvements thereon, including those areas which are to be commonly owned and maintained;
  - j) Evidence that the applicant has sufficient control over the land in question to initiate the proposed development plan within five (5) years; including a statement of all the ownership and beneficial interests in the tract of land and the proposed development; and
  - k) One (1) copy of the Preliminary Plat.
- 4) REVIEW
- a) Review. The Technical Advisory Committee shall review Final Plats at a regular meeting. This shall not be a public hearing.
  - b) TAC Review Criteria. Before taking action, TAC shall find that the facts submitted with the application and presented at the public hearing establish that:
    - i) The proposed development can be initiated within two (2) years of the date of approval;
    - ii) Each individual unit of the development, as well as the total development, can exist as an independent unit capable of creating an environment of sustained desirability and stability or that adequate assurance will be provided that such objective will be attained, the uses proposed will not be detrimental to present and potential surrounding uses, but will have a trespass
    - iii) Beneficial effect which could not be achieved under standard district regulations;
    - iv) The streets as proposed are suitable and adequate to carry anticipated traffic, and increased densities will not generate traffic in such amounts as to overload the street network outside the Planned Unit Development;
    - v) The streets as proposed are suitable and adequate to carry anticipated traffic, and increased densities will not generate traffic in such amounts as to overload the street network outside the Planned Unit Development;
    - vi) Any proposed commercial development can be justified at the locations proposed;
    - vii) Any exception from standard district requirements is warranted by the design and other amenities incorporated in the Final Plat, in accordance with the Planned Unit Development;
    - viii) The area surrounding the development can be planned and zoned in coordination and substantial compatibility with the proposed development;
    - ix) The Planned Unit Development is in general conformance with the Comprehensive Plan

- of the City;
- x) The existing and proposed utility services are adequate for the commercial uses provided; and
  - xi) The proposed open spaces are adequate and appropriate as identified in this Chapter.
- c) Action.
- i) The Technical Advisory Committee shall take action to:
    - (1) approve as presented;
    - (2) approve with supplementary conditions; or
    - (3) disapprove.
  - ii) Following Technical Advisory Committee review, the applicant shall submit revised copies of the plans that address the comments and concerns of the Technical Advisory Committee. The applicant shall refer to the application packet to determine the format and number of copies of the plans to be delivered.
- 5) APPEAL OF A DECISION OF THE DIRECTOR OF THE COMMUNITY DEVELOPMENT DEPARTMENT. The decision of the Community Development Director can be appealed by the Dallas City Council in accordance with *Section. 11.11 - Administrative Appeals Procedure.*
- 6) COMMERCIAL PROJECTS. For a Planned Unit Development that is being subdivided, approval of the Final Plat shall be considered to be the Secondary Plat for recording purposes. Subdivision plat procedures/approval may coincide with, and be approved at the same time as, the Preliminary Plat and the Final Plat.
- 7) COMMENCEMENT OF CONSTRUCTION. No construction or site grading shall begin prior to the issuance of a Land Disturbance Permit. No Zoning Certificate shall be issued for any property for which a Planned Unit Development classification is requested and no construction shall begin until an approved Final Plat is in effect for that phase or property, whichever of the above options is chosen by the applicant. No improvement location permit shall be issued for any structure in any portion of a Planned Unit Development unless and until the final subdivision plat for that portion has been approved by the proper planning authority and recorded in the public record of the City. This requirement may be waived by the Director when it is deemed that a subdivision plat is not required.

#### Sec. 6.08 – ALTERNATIVE SUBMISSION FOR FINAL PLAT

- 1) APPLICATION. The applicant need not file a Preliminary Plat if filing a Final Plat for the entire site, incorporating all requirements of both the Preliminary and Final Plats as described in this Section. The Final Plat shall be filed with the Community Development Director by at least one (1) owner, or his/her designee, of the property for which the Planned Unit Development is proposed. Each application shall be signed by the owner, attesting to the truth and exactness of all information supplied on the application for Final Plat. At a minimum, the application shall contain the following information:
- a) A survey of the tract that is to be developed showing existing features of the property including streets, alleys, easements, utility lines, existing land use, general topography and physical features;
  - b) A development plan showing the location and arrangement of all existing and proposed structures, the proposed traffic circulation pattern within the development, the areas to be developed for parking, the points of ingress and egress including streets where required the relationship of abutting land uses and zoning districts, proposed lots and

- blocks, if any, and proposed public or common open space, if any, including parks, playgrounds, school sites and recreational facilities, screening, and areas to be left in their natural state;
- c) A statement of the proposed total gross floor area, and the percentage of the development which is to be occupied by structures;
  - d) Floor plans of the proposed structures; Landscaping plans;
  - e) When a Planned Unit Development is to be constructed in stages or units, a schedule for the development of such stages or units shall be submitted. When a Planned Unit Development provides for common open space, the total area of common open space provided at any stage of development shall, at a minimum, bear the same relationship to the total open space to be provided in the entire Planned Unit Development as the stages or units completed or under development bear to the entire Planned Unit Development;
  - f) Evidence that the applicant has sufficient control over the tract to affect the proposed plan, including a statement of all the ownership and beneficial interests in the tract of land and the proposed Development;
  - g) In the case of a residential planned unit development, the proposed density to which the Development shall be limited;
  - h) In the case of Office, Commercial, or Industrial, a statement identifying the principal type of office, business and/or industrial uses that are to be included in the proposed Development;
  - i) When a Planned Unit Development includes provisions for common open space or recreational facilities, a statement describing the provision that is to be made for the care and maintenance of such open space or recreational facilities. If it is proposed that such open space be owned and/or maintained by any entity other than a governmental authority, copies of the proposed Chapters of incorporation and bylaws of such entity shall be submitted; and
  - j) Copies of any restrictive covenants that are to be recorded with respect to property included in the Planned Development District.
- 2) EXPIRATION. Approval shall expire and may be revoked if construction on the project has not begun within two (2) years from the date of issuance of the approval and such requirement shall be clearly stated on the application.

#### **Sec. 6.09– TIME LIMIT FOR APPROVED PUD MASTER PLAN**

---

- 1) In the event that a PUD Master Plan is given approval, and the landowner(s):
  - a) Fail to obtain approval for improvement plans or a development order for all infrastructure improvements to include utilities, roads and similar improvements required by the approved PUD Master Plan or other development orders for at least fifteen (15 %) percent of the gross land area of the PUD site every five (5) years of the date of approval by the Dallas City Council; and/or
  - b) Fail to receive final local development orders for at least fifteen (15%) percent of the total number of approved dwelling units in the PUD, or in the case of PUD's consisting of non-residential uses, thirty (30%) percent of the total approved gross leasable floor area within the PUD every six (6) years of the date of approval by the Dallas City Council.
- 2) The project developer shall submit to the Community Development Director a status report on the progress of development annually commencing on the fifth anniversary date of the PUD approval by the City Council. The singular purpose of the report will be to evaluate whether or not the project has commenced in earnest in accordance with the criteria set forth above.

- 3) Should the Director determine that the development has commenced in earnest, then upon review and consideration of the report provided by the owner and any supplemental information that may be provided, the City Council shall elect one of the following:
  - a) To extend the current PUD approval for a maximum period of two (2) years; at the end of which time, the owner will again submit to the procedure as defined herein.
  - b) Require the owner to submit an amended PUD in which the unimproved portions of the original PUD shall be consistent with the Comprehensive Plan. The existing PUD shall remain in effect until subsequent action by the Council of the submitted amendment of the PUD.
  - c) If the owner fails to submit an amended PUD within six (6) months of Council action to require such an amended submittal, then the Council may initiate proceedings to rezone the unimproved portions of the original PUD to an appropriate zoning classification consistent with the procedures in *Section 11.05 – Zoning Map and Text Amendments*.

#### **Sec. 6.10 – PUD ABANDONMENT**

---

- 1) In the event of the abandonment of a Planned Unit Development authorized under this section, the City Council may initiate an amendment to the Zoning Ordinance so that the land will be zoned into a category or categories which approximates its existing use or such other zoning category or categories which it deems appropriate.
- 2) Abandonment shall be deemed to have occurred when no improvements have been made pursuant to the approved Final Plat for twenty-four (24) consecutive months. The twenty-four (24) month time limitation may be extended at the discretion of the City Council.

#### **Sec. 6.11 – AMENDMENTS TO THE CONCEPT PLAN AND FINAL PLAT**

---

- 1) No changes shall be made in the approved Concept Plan or plats unless in conformance with the following requirements. The term "minor changes" as used in this section is considered to represent changes that do not alter the overall characteristics of the total plan and that create no adverse impacts on adjacent uses or public services and facilities. Some examples of what can be considered as minor changes are:
  - a) Minor Change. The Community Development Director may authorize minor changes under the following conditions:
    - i) Changes in location and type of landscaping and/or screening so long as the approved character and intent is maintained;
    - ii) Changes in the orientation of portions of parking areas so long as the effectiveness of the overall site circulation and parking is maintained; parking areas shall be relocated not closer than twenty (20) feet to any residential structure or ten (10) feet to any street or right-of-way lines; and the number of parking spaces shall not be reduced by the relocation;
    - iii) Changes in the location of sidewalks and pathways, provided that continuity of pedestrian circulation remains;
    - iv) The reorientation, but not complete relocation of structures;
    - v) Changes that will not impact properties or uses outside of and adjacent to the PD; or
    - vi) Redesign of open space that does not decrease the recreational, buffering, or environmental benefits of the open space.
  - b) Prohibitions. No minor change authorized by this section may cause any of the following:
    - i) Change in the permitted uses or of development character;
    - ii) increased overall coverage of structures;
    - iii) increased density or intensity of use;
    - iv) increased demand for traffic circulation and public utilities;
    - v) decrease in public or private open space;

- vi) decrease in pavement and sidewalk widths; or
- vii) increased numbers of dwellings.
- c) Major Change. All other changes to the approved Concept Plan or plats shall be deemed "major" and shall be approved only by the Council after review of a revised Final Development Plan and/or Map. No amendments may be made in the approved Final Development Plan unless the applicant establishes that such amendments are required as a result of:
  - i) changes in conditions that occurred after Final Development Plan approval;
  - ii) changes in the development policy of the community; or
  - iii) conditions that were reasonably unforeseen at the time of Final Development Plan approval.
- 2) Recording of Changes and Amendments. Any changes that are approved for the Final Development Plan and/or Final Plat shall be recorded as amendments to the previously recorded Plan and/or Map.

#### **Sec. 6.12 – TRANSFERABILITY AND ENFORCEMENT OF STANDARDS**

---

- 1) All commitments, conditions, stipulations, ordinance requirements, PUD Booklets, Concept Plans, and PUD Ordinances are shall be entered into the legal record by filing in the County Recorder's Office.
- 2) All future developers, owners, builders, applicants, successors and assigns shall be bound by all commitments, conditions, ordinance requirements, PUD Booklets, Concept Plans, Plats, and PUD Ordinances from any annexation, rezoning, variance or special exception unless relief is granted by the City Council.
- 3) Applicant/Developer/Owner agrees and acknowledges that all conditions or stipulations of re-zoning shall bind applicant/developer/owner's successors and assigns.

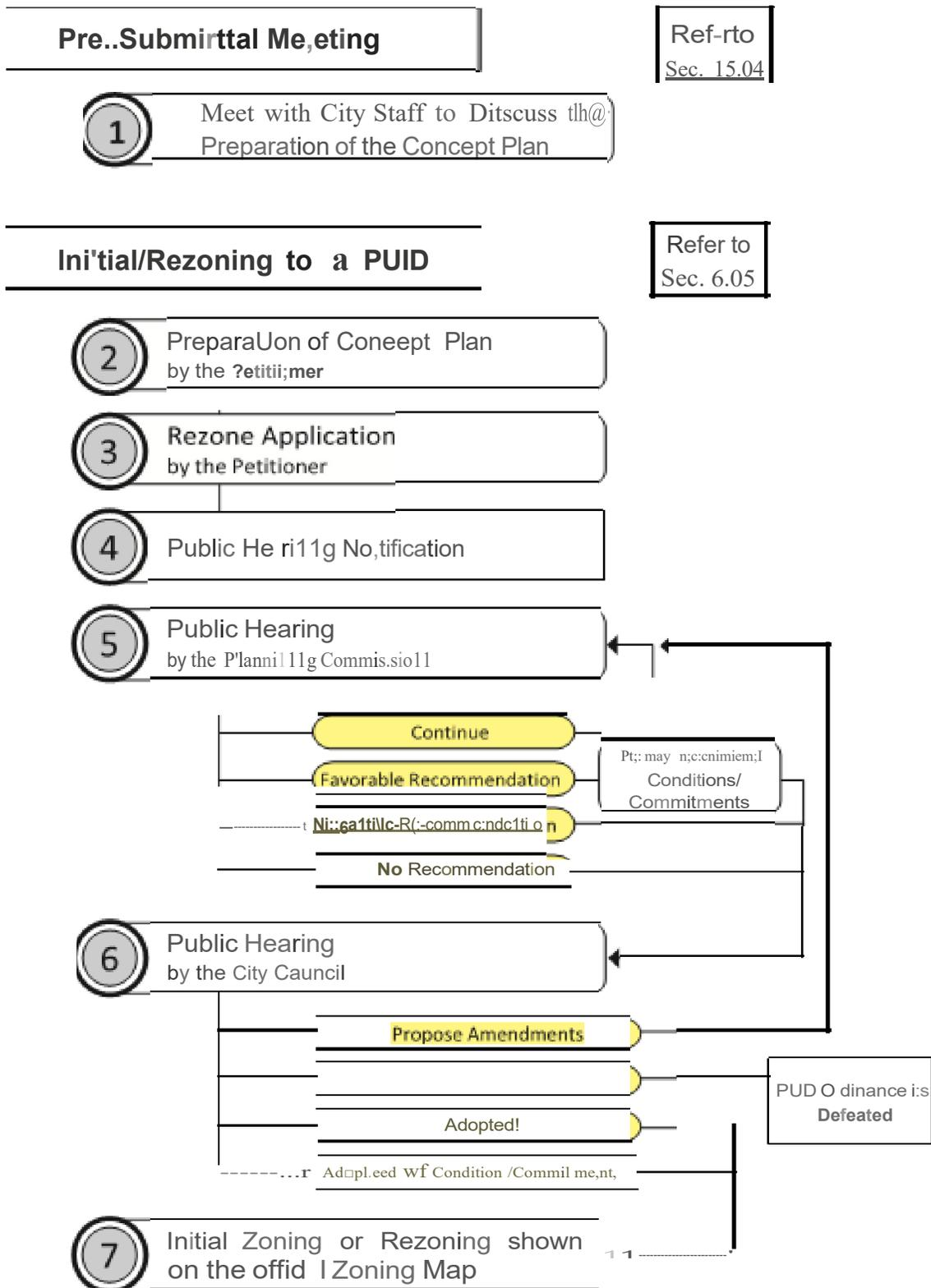
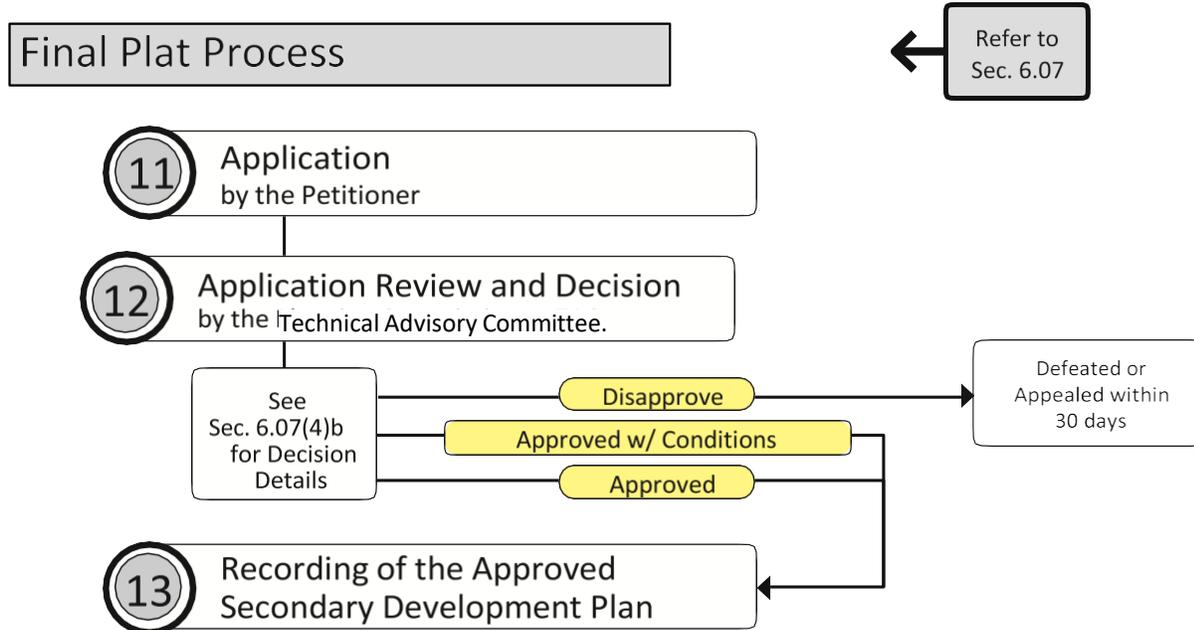
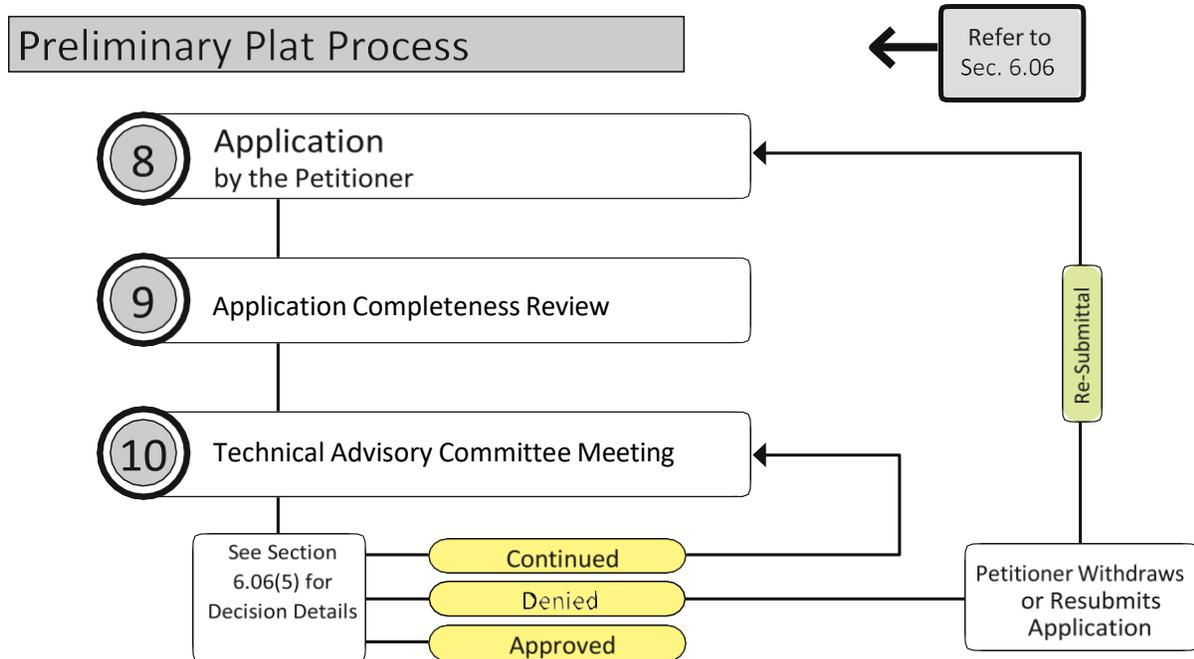

Figure 6.2: Preliminary/Final Plat Flow Chart

\* If denied by the TAC, an appeal can be made to the City Council per *Section 11.11*.



CHAPTER VII – DEVELOPMENT STANDARDS

**Sec. 7.01 – INTRODUCTION AND APPLICATION**

- 1) INTRODUCTION. All structures, land uses, land use changes, structural alterations, structural relocations, structural additions, and structural enlargements of legally conforming uses that are constructed, created, established, or occur after the effective date of this Ordinance (except as may otherwise be provided within this Ordinance) shall be subject to all Development Standards and regulations applicable to the zoning district in which they are located. All development plans approved prior to the effective date of this Ordinance shall adhere to the terms and conditions of approval and/or written commitments made under the zoning ordinance that was in place at the time of filing.
  - a. All changes of use proposed within existing structures on developed parcels shall be exempt from all supplementary regulations within this ordinance except parking, lighting and landscaping requirements.
  - b. All changes of use proposed within new structures or structures expanded beyond 35% of the existing structure’s square footage on developed parcels shall be subject to all applicable regulations within this ordinance as set forth herein.
  - c. All changes of use proposed within existing buildings, new buildings, or buildings expanded beyond thirty-five percent (35%) of the existing structure’s square footage, and located on underdeveloped or undeveloped lots shall be subject to all applicable regulations within this ordinance as set forth herein.

Table 7.0: Change of Use Chart

	Undeveloped Lot	Underdeveloped Lot	Developed Lot
Existing structure	N/A	All regulations	Parking, Lighting and Landscaping Regulations
Expansions beyond 35% of a structure’s square footage	N/A	All regulations	All regulations
New Structure	All regulations	All regulations	All regulations

- 2) REQUIREMENTS FOR USES PERMITTED BY SPECIAL EXCEPTION. Any use which is permitted by Special Exception shall be consistent with the standards for the zoning district in which the use is permitted by this Ordinance. The City Council may adopt conditions of approval for any use permitted by Special Exception.
- 3) USES PERMITTED PER LOT. Only one principal use (whether a permitted or Special Exception use) of a lot shall be permitted. All other uses occurring on a lot shall be accessory to or a subordinate component of the principal use. For properties proposed to include a mix of uses or platted under the horizontal property regime, several compatible principal uses sharing a structure/structures may be considered collectively as the principal use. This shall apply to uses including and similar to shopping centers, retail and residential contained within the same structure, or residential condominiums.

**Sec. 7.02 – OFF-STREET PARKING AND LOADING**

---

- 1) PURPOSE. The purpose of this section is to provide adequate and appropriate areas for the size, location and construction of off-street parking areas and loading areas for new or converted uses within the City. Refer to *Section 7.03 – Entrance/Drive Standards* for parking lot entrance drive standards.
- 2) GENERAL REQUIREMENTS
  - a) Any building, structure or use of land, when erected or enlarged, shall provide for off-street parking spaces for automobiles in accordance with the following provisions of this section. A parking plan shall be required for all uses except single- and two-family dwellings (ADU). The parking plan shall be submitted to the City as part of the Development Plan Review process. The plan shall show the boundaries of the property, parking spaces, access driveways, circulation patterns, drainage and construction plans, illumination, boundary walls, fences and screening, as appropriate.
  - b) Whenever a building or use constructed or established after the effective date of this Zoning Ordinance is changed in use or enlarged in floor area, number of employees, number of dwelling units, seating capacity or otherwise to create a need for an increase of ten percent (10%) or more in the number of existing parking spaces, such spaces shall be provided on the basis of the enlargement or change.
  - c) Whenever a building or use existing prior to the effective date of this Ordinance is enlarged to the extent of thirty-five percent (35%) or more in floor area or in the area used, such building or use shall then comply with the parking requirements set forth herein.
- 3) REVIEW PRIOR TO ISSUANCE OF IMPROVEMENT LOCATION PERMIT. Any proposed new development or conversion for which a Land Disturbance Permit (LDP) is required as specified in *Chapter XI: Petitions, Permits, and Procedures* shall be reviewed for conformance to the requirements of this chapter.
- 4) DESIGN STANDARDS. All off-street parking facilities shall be in accordance with the following standards and specifications:
  - a) DESIGN AND CONSTRUCTION OF PARKING AREAS. The following standards shall apply to the design of off-street parking areas as they are required in this section for all new or converted multifamily, commercial, industrial or quasi-public uses:
    - i) Minimum Size and Maneuvering Space. The minimum size of a parking space shall be as shown on *Table 7.1: Parking Dimensions* and *Figure 7.2: Parking Aisle and Space Dimensions*. In no instance shall the overhang of a vehicle be considered as part of the required parking space area. Minimum dimensions for semi tractor-trailer parking at truck stops shall be 12.5' x 65'.
      1. All parking spaces shall be provided with adequate maneuvering space into which vehicles can back for the purpose of exiting the parking space.
      2. Proximity. The parking spaces for dwelling units shall be located on the lot.
      3. Location. Off-street parking spaces may be located in front of a structure, but not within the required landscape buffer or utility and drainage easements, unless approved by the Community Development Director.
      4. Setbacks. In no case shall a parking area be located closer than ten (10) feet from any right-of-way or adjacent property line. Parking areas shall be separated by a minimum of five (5) feet from the façade of a building or structure by an elevated

sidewalk or planting strip.

- b) DESIGN AND CONSTRUCTION OF THE PARKING LOT ENTRANCE DRIVE. Refer to *Section 7.03 –Entrance/Drive Standards.*

Angle of Parking	Minimum Parking Space Size		Minimum Aisle Width
	Width	Length	
Parallel	8 feet	22 feet	on-street
90 Degree	9 feet	18 feet	24 feet (two-way aisle)
60 Degree	9 feet	20 feet	18 feet (one-way aisle)
45 Degree	9 feet	19 feet	14 feet (one-way aisle)
Disabled	(refer to ADA guidelines)		

- 5) PAVING AND DRAINAGE. All parking areas, regardless of size, shall be a hard, dust-free surface. Pavement type and thickness shall be reviewed by the City Engineer, taking into consideration soil conditions and traffic loading. Porous pavement and pavers may also be used if approved by the Technical Advisory Committee or the Community Development Director. Pavers shall include durable materials, suitable for parking such as cobblestones, brick, concrete formed blocks or cut stone, the system of which is specifically installed and designed for vehicular loads.

- a) EXCEPTIONS. Loose paving materials, including gravel, may be used on parcels of five (5) acres or more with primarily agricultural uses, as approved by the City Engineer, or for other uses by variance.

- 6) STORMWATER MANAGEMENT. Stormwater runoff created as a result of the

Figure 7.2: Parking Aisle and Space

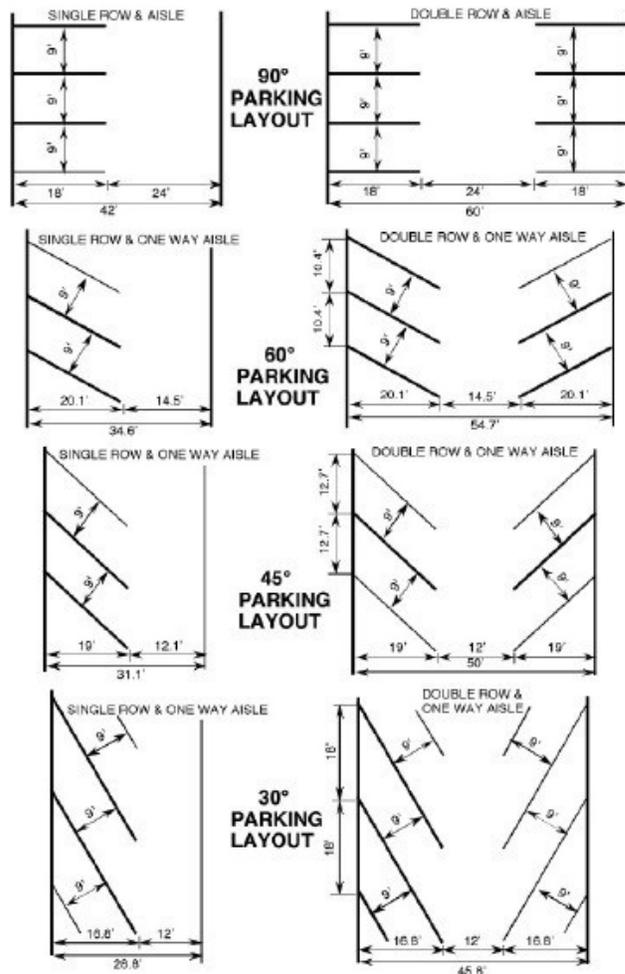

Parking Lot Layout Dimensions

improvements to the parking area shall be controlled in such a manner so as to eliminate draining onto neighboring properties. Improved parking areas shall be incorporated into the stormwater management plan for the proposed project. Innovative drainage techniques or stormwater best management practices (BMPs) are recommended. Site grading as well as stormwater control provisions shall be reviewed and approved by the City Engineer prior to site construction.

- 7) BARRIERS. Wherever a parking space extends to a property line, sidewalk, walkway, landscaping, or fencing, the inclusion of wheel stops, concrete curbs, or other suitable barriers shall be required in order to prevent any part of a parked vehicle from extending beyond the property line, sidewalk, or walkway, and from destroying the screening materials.
- 8) VISIBILITY. Entrance drives for parking areas shall be located in such a way that any vehicle entering or leaving such parking area shall be clearly visible by any pedestrian or motorist approaching the access or driveway from a public street, private street or alley.
- 9) MARKING. All parking areas for more than five (5) vehicles shall be marked with paint lines or in some other manner approved by the City and shall be maintained in a clearly visible condition.
- 10) MAINTENANCE. All off-street parking areas shall be continually maintained in satisfactory condition so as to be safe, attractive and free of any hazard, nuisance or other unsafe condition.
- 11) SIGNAGE. Signs shall be in conformance with the *Chapter 28: Dallas Sign Ordinance*.
- 12) LIGHTING. When lighting facilities are used, such lighting shall be in accordance with *Section 7.12 – Outdoor Lighting*.
- 13) LANDSCAPING. Refer to *Section 7.05 – Landscaping Standards* for landscaping requirements. Refer to *Subsection 7.05(6)(c)(ii)* if the minimum number of parking spaces is exceeded.
- 14) STACKING SPACES FOR DRIVE-THROUGH BUSINESSES
  - a) For the purposes of this Ordinance, one stacking space shall be construed as a minimum of nine (9) feet in width and nineteen (19) feet in length.
  - b) Businesses utilizing drive-through windows or those that offer drive-through facilities shall meet the requirements set forth within Table 8.2: Stacking Space Schedule and all applicable regulations within *Section 8.09 – Drive Through Businesses*.
  - c) Additional stacking space may be required based on the number of vehicles utilizing the drive-through at peak hour.
  - d) Lane widths should be delineated with pavement markings. However, individual spaces within the lane need not be marked.
    - i) Exception: Automobile filling stations do not need to delineate lane widths or individual spaces with pavement markings.
  - e) Stacking spaces shall be in addition to the required parking spaces and must not be located within a required driveway,

Figure 7.1: Parking Calculation Example

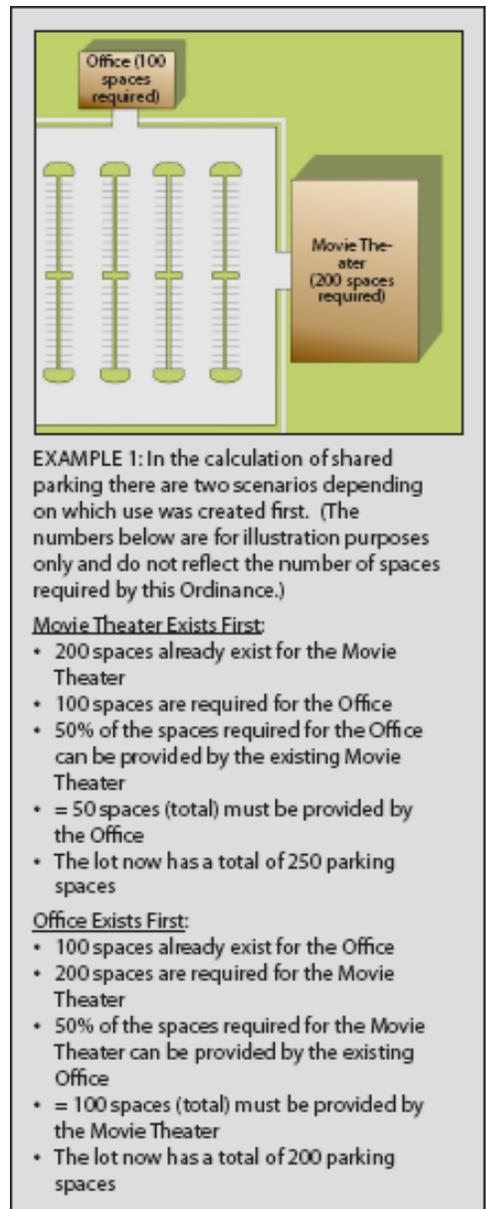

- internal circulation system, or parking aisle.
- f) Stacking spaces shall begin at the point of transaction including all service windows, service bays, and automated teller machines.
- 15) TURNING RADII. Sufficient turning radii shall be provided in accordance with approved engineering standards so as to be adequate for all vehicle movement, including fire and safety vehicles, school buses or other oversize vehicles which may make use of the area. Stacking spaces shall be in addition to the required parking spaces and must not be located within a required driveway, internal circulation system, or parking aisle.
- 16) PARKING OF COMMERCIAL VEHICLES.
- a) In commercial and industrial districts, commercial vehicles with or without signage which are over eight (8) feet in width and/or nineteen (19) feet in length shall not be stored in a parking area. Such vehicles shall be parked or stored in the required off-street loading space(s) or to the rear of the principal building when not in use or during non-business hours. Truck stops shall be exempt from this section.
  - b) Where Special Exception approval is required, the City Council shall evaluate the potential impacts of noise, glare, dust, debris, traffic, public safety, and security, among other measures. Such locations, where approved, will need to be appropriately buffered, screened, and surfaced as to minimize quality of life and environmental impacts. Truck stops shall not be located within 500 feet of a property zoned R-1, R-2, R-3, TH, MF-1, MF-2, or OMI.
    - i) Truck parking as a primary use on any commercial or industrial lot shall not have any trucks that are parked or stationary on the lot for more than forty-eight (48) hours at a time.
    - ii) In the event that there is not a principal building on site, all trucks must be parked behind the front yard setback. Under no circumstance may trucks be parked within a required setback area.
    - iii) Trailers may not be parked on any lot without being directly connected to a semi-tractor.
  - c) With the exception of properties utilized for agricultural use, truck parking (except the temporary parking for the delivery of goods and/or services) and the outdoor storage of trucks over seventy-five hundred (7,500lbs.) pounds gross vehicle weight and or eight (8) feet in height, buses, and semi-tractor and/or trailers shall not be permitted in residential districts. No vehicles shall be parked for the purposes of advertising alongside interstates and highways in any zoning district.
- 17) PARKING OF NON-COMMERCIAL MOTOR VEHICLES. The parking of recreational vehicles, travel-trailers, boats, vehicle carrier trailers (including automobiles, snowmobiles, motorcycles, etc.), equipment trailers, and other non-commercial motor vehicles associated with residential uses are subject to the following requirements:
- a) At no time shall any parked or stored recreational vehicle be occupied or used for living, sleeping, or housekeeping purpose.
  - b) The Director may require a land owner to verify that the vehicle is licensed and operational.
  - c) In any District the wheels or any similar transporting devices of any recreational vehicle shall not be removed except for repairs, nor shall such vehicle be otherwise permanently fixed to the ground in a manner that would prevent ready removal of said types of mobile structures.
  - d) The outside storage of motor vehicles used for motorsports shall be prohibited.
- 18) SPECIAL AREA DESIGNATION. Development Plans for proposed projects shall identify the location of handicapped spaces, trash receptacles, cart corrals, fire lanes or other special areas as may be required by other local, state or federal laws.

## 19) OFF-SITE AND SHARED PARKING

- a) Off-Site Parking. Off-site parking may be allowed on another lot that is within five-hundred (500) feet of the lot occupied by the use(s) for which it is required. A formal agreement between property owners shall be provided prior to Development Plan approval. The agreement shall be recorded with the Plat.
- b) Shared Parking. Shared parking may be allowed between two (2) or more lots that share property lines.
  - i) Uses with Similar Business Hours. The total of such off-street parking spaces supplied collectively for multiple uses with similar business hours, where all uses are located within a shopping center or a retail/office/business park subdivision, may be less than the sum of the requirements for the various uses computed separately. In no case shall the sum of the requirements for the various uses be reduced by more than fifteen percent (15%) of the required parking for uses when computed separately as determined by the planning staff.
  - ii) Uses with Dissimilar Business Hours. Churches, civic clubs, auditoriums, lodge halls, banquet halls, movie theaters, and stadiums may make arrangements with existing business establishments which normally have different hours of operation for sharing up to fifty percent (50%) of their required parking spaces (Example 1), provided however, where there is a sharing of facilities by different owners or tenants, there shall be a written agreement approved by the Community Development Director. In addition, should any of the uses having a joint agreement after passage of this Ordinance be changed or facilities discontinued, then the required spaces for the use or uses remaining shall be provided elsewhere as a condition precedent to the continued use of the building or buildings. The approved agreement shall be recorded with the County Recorder, and a copy kept on file with the Community Development department.
- c) Approval Requirements. All off-site and shared parking space arrangements are subject to the approval of the Director. Approvals shall be based on the determination that the use of off-site and/or shared parking will not provide hardships for pedestrians, will not result in potentiality hazardous traffic conditions, and will provide an adequate number of parking spaces for the uses involved. The parking needs of possible future uses of the property shall also be considered by the Director.

20) PARKING LOTS IN SPECIAL AREAS. Refer to *Chapter V: Infill Development Standards* for additional parking standards.

21) PARKING LOTS IN RESIDENTIAL DISTRICTS. The Planning & Zoning Commission or Community Development Director may approve parking lots in the residential zoning districts subject to the following conditions:

- a) The parking lot shall be accessory to and for the use in connection with one or more permitted or Special Exception permitted uses in and adjoining commercial and industrial districts.
- b) The parking lot shall contain not less than five-thousand (5,000) square feet, which shall abut at least fifty (50) feet, either directly or across an alley or street, on the district in which the use for which the parking is provided, permitted or conditionally permitted.
- c) The parking lot shall be used solely for the parking of passenger vehicles and no commercial repair work or service of any kind shall be conducted on the parking lot.
- d) No sign of any kind, other than those designating entrances, exits, conditions or use and penalties for improper use shall be maintained on the parking lot.

- e) The parking lot located in a residential district shall not be illuminated after 9 p.m., with the exception of multifamily developments.
  - f) Entrances and exits shall be at least twenty (20) feet from any adjacent property located in a residential district.
  - g) Refer to *Section 7.05 – Landscaping Standards* for landscaping and screening standards.
- 22) BICYCLE PARKING. When located within five-hundred (500) linear feet from the nearest property line to a dedicated public bike/ped trail system, all non-residential uses shall provide one designated bicycle parking area for every twenty-five (25) vehicle parking spaces required by this Ordinance, with a minimum provision for three (3) bicycle spaces. Each bicycle area shall provide adequate facilities for securing the parked bicycles.
- 23) MODIFICATION. The Zoning Board of Appeals and City Council shall have the authority to modify any of the requirements of this section in accordance with *Subsection 2.04 – Zoning Board of Appeals* and *Section 2.06 – City Council*.
- 24) LOADING AND UNLOADING SPACES REQUIRED. Every building used for nonresidential purposes which customarily receives or distributes goods by motor vehicle shall provide sufficient space on the premises for all loading and service purposes on the basis of the following minimum regulations:
- a) Number of Loading and Unloading Spaces Required
    - i) Loading space as required under this section shall be provided as area additional to off-street parking spaces required by other provisions of this chapter and shall not be considered as supplying off-street parking space.

Table 7.2: Number of Loading Spaces	
Buiding Area	Number of Loading Spaces Required
Less than 5,000 square feet	No spaces required
5,000 square feet but less than 20,000 square feet	One (1) space required
20,000 square feet or more	Two (2) spaces required plus one (1) additional space for each 20,000 square feet over the initial 20,000 square feet

- b) Loading and Unloading Space Design Standards
  - i) Dimensions. Every loading and unloading space shall not be less than twelve (12) feet in width, forty (40) feet in length, and fourteen (14) feet clearance.
  - ii) Access. Access to truck loading and unloading spaces shall be provided directly from a public street or alley or from any right-of-way that will not interfere with public convenience and that will permit the orderly and safe movement of such trucks.
  - iii) Surfacing. All open loading spaces shall be graded and provided with a durable and dustless hard surface of asphalt, concrete, or other suitable materials capable of withstanding one thousand (1,000) pounds per square inch (psi).
  - iv) Drainage. All loading spaces shall be provided with adequate drainage facilities as approved by the City Engineer during the Development Plan Review process.
  - v) Location. No loading shall occur in a yard abutting a residential use and/or zone unless approved by the Planning & Zoning Commission.
  - vi) Screening. Landscaping and screening shall be as indicated in *Section 7.05 – Landscaping Standards*. The Planning & Zoning Commission shall have the power to determine the need

for an additional amount of planting/landscaping, materials, walls, fences or any combination of these as deemed necessary.

- vii) Lighting. When lighting facilities are used, such lighting shall be in accordance with *Section 7.12 – Outdoor Lighting*.

25) MINIMUM NUMBER OF PARKING SPACES. *Table 7.4: Minimum Parking Space Requirements* shall be used to determine the minimum number of parking spaces required for the specified use.

- a) Maximum Spaces. The maximum number of permitted parking spaces is the minimum required number of spaces plus ten percent (10%).
  - i) For proposed parking lots of more than one-hundred (100) parking spaces that exceed the maximum number of permitted spaces (see *Section 7.02(25)a* above), the Planning & Zoning Commission may increase the minimum amount of required interior landscaping by five percent (5%), and may require that the additional paved area be constructed with pervious pavement.
- b) Requirements for Uses Not Specified. Where a use is not specifically mentioned in *Table 7.4: Minimum Parking Space Requirements*, the requirements for a use which is so mentioned and to which said use is similar shall apply.
- c) Right-of-Way. No parking, loading or servicing of vehicles shall be done on the right-of-way of any publicly dedicated thoroughfare. This section is not intended to exclude vehicles from on-street parking in areas zoned CBD.
- d) Net Floor Area Measurement. For the purpose of determining parking space requirements in this section, the term “net floor area” means the area used for service to the public and excludes area used principally for non-public purposes such as storage, incidental repair, processing, show window, mechanical rooms, elevator shafts, stairwells, rest rooms and dressing rooms. Any derived number with a fractional value of more than fifty percent (50%) shall be rounded to the next highest whole number.

26) PARKING FOR PERSONS WITH DISABILITIES

- i) Required in All Parking Lots Parking spaces for persons with disabilities shall be provided in all parking lots in accordance with Americans with Disabilities Act Accessibility Guidelines (ADAAG) for Buildings and Facilities.
- ii) Standards Vehicular access aisle widths shall be the same as for perpendicular parking spaces. A handicap access aisle shall be provided adjacent to each handicap parking space and may be shared between adjacent handicapped parking spaces. If parking spaces are provided for self-parking by employees or visitors, or both, then accessible spaces shall be provided in each such parking area in conformance with the table below. Spaces required by the table need not be provided in the particular lot. They may be provided in a different location if equivalent or greater accessibility, in terms of distance from an accessible entrance, cost and convenience is ensured. Dimensions for disabled parking are provided in *Figure 7.4*.
- iii) Number of Required Parking Spaces The number of parking spaces to be provided for

Parking Capacity	Required Minimum Spaces for Persons with Disabilities
1-25	1
26-50	2
51-75	3
76-100	4
101-150	5
151-200	6
201-300	7
301-400	8
401-500	9
501-1000	2% of total
1,001 and over	20 plus 1 for each 100 over 1,000

persons with disabilities shall comply with *Table 7.3: Parking for the Disabled*.

iv) Marking All handicapped accessible spaces shall be clearly marked as such.

Table 7.4: Minimum Parking Space Requirements	
Type of Use	Minimum Required Parking
<b>Agricultural</b>	
Animal Breeding (commercially)	one (1) space per employee on largest shift
Farm Equipment Sales & Service	one (1) space per five hundred (500) square feet of enclosed sales area, plus one (1) space per two thousand five hundred (2,500) square feet of open sales area, plus one (1) space per employee on the largest shift
General Farming Uses	two (2) spaces per dwelling unit
Greenhouse or Plant Nursery	one (1) space per three hundred (300) square feet of interior sales, plus one (1) space per employee on the largest shift
Horse Stable (commercial)	one (1) space per four (4) stalls, plus one (1) space per employee on the largest shift
Truck Garden or Produce Stand	four (4) spaces per individual owner-occupied stand
<b>Residential</b>	
Accessory Apartments	one (1) space per dwelling unit
Amenity Area	one (1) space per three hundred (300) square feet of clubhouse or lodge space, plus one (1) space per two hundred fifty (250) square feet of non-competition pool
Assisted living/Senior Housing	eight-tenths (0.8) spaces for every patient/resident room/unit
Bed and Breakfast Establishment or Boarding House (owner must live on-premises)	one (1) space for each guest room, plus two (2) spaces for the owner
Facility for the Developmentally / Mentally Disabled	one (1) space for each employee on the largest shift, plus one (1) space per three (3) clients
Group Home	one (1) space per five (5) residents, plus one (1) space per employee on the largest shift
Manufactured Home Park	two (2) spaces per unit, plus one (1) visitor space for ever two (2) units
<b>Multi-Family</b>	
Studio or 1 Bedroom	one (1) space per unit, plus one (1) visitor space per three (3) units
2 Bedrooms	1.6 spaces per unit, plus one (1) visitor space per three (3) units
3 Bedrooms	1.8 spaces per unit, plus one (1) visitor space per three (3) units
4 Bedrooms	two (2) spaces per unit, plus one (1) visitor space per three (3) units
each bedroom after 4	add 0.5 spaces per additional bedroom
Nursing home or convalescent care facility	one (1) space for every four (4) beds, plus one (1) per employee on the largest shift
<b>Single-, two-family, and manufactured home</b>	
Up to 3 Bedrooms	two (2) spaces per unit
4 or more Bedrooms	three (3) spaces per unit
<b>Institutional</b>	
<b>Education</b>	
Elementary and Junior High/Middle School	two and one-half (2.5) spaces per classroom
High School	one (1) space for every five (5) students of design capacity, plus two (2) spaces for each classroom OR one (1) space for every four (4) seats in any auditorium or assembly hall, whichever is greater
Nursery School	one (1) space per employee on largest shift, plus one (1) space per five (5) attendees
University, College or Vocational School	one (1) space for every three (3) students of design capacity
<b>Other</b>	
Club or Lodge	one (1) space for every fifty (50) square feet of net floor area
Community Center	one (1) space for every three (3) people at maximum capacity
Funeral Home	one space for every seventy-five (75) square feet of parlor or chapel space; or one (1) space per five (5) seats, whichever is greater. This number shall be exclusive of spaces dedicated to hearses, company vehicles or ambulances
Government and Municipal Building	one (1) space for each three hundred (300) square feet of net floor area
Hospital	one (1) space for each two (2) patient beds (excluding bassinets), plus one (1) space for each person on largest shift
Places of Worship	one (1) space per four (4) fixed seats or eighteen (18) linear feet of bench; if no fixed seating, one (1) space per twenty-eight (28) square feet of main auditorium space
Police/Fire Station	one (1) space for every three hundred (300) square feet of net floor area, plus one (1) space for each vehicle used for fire or police protection
Post Office	one (1) space for each employee, plus one (1) space for every two hundred (200) square feet of usable floor area
Public Library, Art Gallery, or Museum	one (1) space for every five hundred (500) square feet of net floor area
Recycling Center (public)	one (1) space per two thousand five hundred (2,500) square feet of processing /storage space
Recycling Center (sorting/distribution)	one (1) space per five thousand (5,000) square feet of processing / storage space, plus one (1) space per three hundred (300) square feet of administrative/office area

Utility Service Facility/Office	one (1) space per three hundred (300) square feet of administrative/office area, plus one (1) space per company vehicle
Veterinarian Clinic/Animal Hospital (temporary boarding only, for ill or injured animals)	one (1) space for each examination room plus two (2) space for each fifty (50) square feet of reception area

Table 7.4: Minimum Parking Space Requirements	
Type of Use	Minimum Required Parking
<b>Parks &amp; Recreation</b>	
Active Recreation Area (athletic fields, tennis courts, basketball, soccer, baseball, softball, football, playgrounds, etc.)	one (1) space per acre, plus twenty (20) spaces per field, plus five (5) spaces per court
Amphitheater	one (1) space per three (3) seats, plus one (1) space per twenty-five (25) square feet of open seating area, plus one (1) space per employee on the largest shift
Driving Range	one and one-half (1.5) spaces per tee
Golf Course	two (2) spaces for each hole plus one (1) space for each one hundred (100) square feet of net floor area of the clubhouse
Passive/Low Intensity Recreation (unimproved backpacking trails, unimproved hiking trails, picnic areas, primitive camping areas, canoeing and rafting areas, etc.)	two (2) spaces per mile of trail; or one (1) space per three (3) acres
Swimming Pool (excluding private pools on residential lots)	one space for each one hundred (100) square feet of pool and pool deck area
<b>Commercial</b>	
<b>Adult</b>	
Sexually Oriented Business (unlicensed massage parlors, adult book stores, adult entertainment services, etc.)	one (1) space for every three (3) seats; OR one (1) space per two hundred (200) square feet of net floor area, whichever is greater
<b>Motor Vehicle Services</b>	
Motor Vehicle Filling Station	one (1) space for each pump
with service bays	add one (1) space for each bay or work area
with convenience store	one (1) space for each three hundred (300) square feet of enclosed net floor area
Motor Vehicle Sales (automobile, recreational vehicles, motorcycle, truck, trailer, etc.) Customer & Employee Parking	one (1) space for each five hundred (500) square feet of net floor area of sales, shop or garage, plus one (1) space per two thousand five hundred (2,500) square feet of open sales area
Motor Vehicle Service and Repair	three (3) spaces for each bay or work area
<b>Entertainment</b>	
Auditoriums and places of assembly with or without fixed seats	one (1) space per one hundred fifty (150) square feet of seating/display area
Drive-In Movie Theater	one (1) space per vehicle at maximum capacity plus three (3) spaces for employees
Indoor Recreation (billiards, video arcades, ice/roller skating rink)	one (1) space for every four (4) seats; or one (1) space for every four (4) people at maximum capacity
Miniature Golf	one (1) space for every hole
Movie Theater	one (1) space for every four (4) seats, plus one (1) space for each employee
Recreation, Commercial (water parks, sports arenas, batting cages, amusement parks, motor vehicle or animal racing facilities, etc.)	one (1) space for each three (3) seats; or one (1) space for each participant at maximum utilization, whichever is greater
<b>Service Businesses</b>	
Animal Boarding Facility (includes kennel)	one (1) space for every four hundred (400) square feet of net floor area, excluding animal exercise areas
Business, Commercial Service	one space for each three hundred (300) square feet of net floor area
Contractors Service	one (1) space for each five hundred (500) square feet of net floor area
Dance/Aerobics/Gymnastics/Martial Arts Studios	one (1) space for every two hundred fifty (250) square feet of floor area, plus adequate area for safe and convenient loading and unloading of students
Day Care Center (child/adult)	one (1) space for every four (4) attendees; minimum six (6) spaces
Health Service (health club, fitness facility, health spa, etc.)	one (1) space for every three hundred (300) square feet of net floor area
Hotel/Motel	one (1) space for each sleeping room plus one (1) space for each four hundred (400) square feet of public meeting area and/or restaurant space
Personal Service (barber shops, beauty parlors, nail salon, etc.)	two and one half (2.5) spaces per customer services chair
Self Service Storage Facility	one (1) space for each twenty (20) rental storage units; no less than three (3) spaces
Shoe Repair	one (1) space for every four hundred (400) square feet of net floor area
<b>Professional/Office</b>	
Clinics	one (1) space for every four hundred (400) square feet of net floor area
Financial Institutions	one (1) space for every three hundred (300) square feet net floor area, plus stacking space for five (5) vehicles at each vehicular service window
Bank Machine / AT M Walk-Up Facility	two (2) spaces per AT M
Professional Office (general, law, insurance, travel, design, etc.)	one (1) space for each three hundred (300) square feet of net floor area
<b>Restaurant/Food Preparation</b>	
Bakery, Retail	one (1) space for every five hundred (500) square feet of floor area; minimum five (5) spaces
Coffee Shop	one (1) space per two (2) seats; minimum six (6) spaces
Restaurant	one (1) space per three (3) seats, plus one (1) space for each employee on largest shift

with vehicular service window	one (1) space per two (2) seats, plus seven (7) stacking spaces per drive-through lane, where applicable
if no indoor seating	minimum ten (10) spaces
Bar / Tavern	one (1) space for every three (3) seats; OR one space for each one hundred square feet of net floor area, whichever is greater(100)

Table 7.4: Minimum Parking Space Requirements	
Type of Use	Minimum Required Parking
<b>Retail Businesses</b>	
Business, Retail	one space for each three hundred (300) square feet of net floor area; minimum six (6) spaces
Supermarket / Convenience Store	up to 5,000 square feet: one (1) space for every two hundred fifty (250) square feet of net floor area greater than 50,000 square feet: one (1) space for every three hundred (300) square feet of net floor area
Hardware Store / Appliance Sales	one (1) space for every four hundred (400) square feet of net floor area
Apparel / Shoe Store	one (1) space for every three hundred (300) square feet of net floor area
Furniture Store	one and one half (1.5) spaces for ever one thousand (1000) square feet of net floor area
Business, Wholesale	one (1) space for each five hundred (500) square feet of net floor area
Shopping Center / Big Box	
≤100,000 square feet gross leasable	one (1) space per three hundred (300) square feet for the first ten thousand (10,000) square feet and one (1) space per each four hundred (400) square feet thereafter
between 100,001-500,000 sq ft gross leasable area	one (1) space per three hundred fifty (350) square feet for the first ten thousand (10,000) square feet and one (1) space per each four hundred (400) square feet thereafter
>500,000 sq ft gross leasable area	one (1) space four hundred (400) square feet
<b>Industrial</b>	
Manufacturing	one (1) space per employee on largest shift, plus one (1) visitor space per ten (10) employees
Research and Testing	
Salvage Yard	
Solid Waste Transfer Station	
Warehousing, Distribution, or Flex Tenant	

**Sec. 7.03 – ENTRANCE/DRIVE STANDARDS**

- 1) INTENT. The purpose of these entrance and drive standards is to provide for a safe and efficient vehicular and pedestrian transportation system by establishing minimum standards for site entrance drives, driveways, and interior drives.
- 2) GENERAL ENTRANCE/DRIVE STANDARDS APPLICABLE TO ALL ZONING DISTRICTS.
  - a) General Requirements. All driveways and interior drives shall conform to the following design requirements:
    - i) Entrance Drives and Driveway Widths. Entrance drives shall conform to the following minimum pavement widths up to and at the point which they intersect the public right-of-way. The distances for these standards shall be determined by measuring from the outside edges of the curb or pavement (whichever is more) of the entrance or drive at the public right-of-way which it accesses. The distance shall not include any acceleration or deceleration lanes or turning radii. The width shall be:
      - 1) Fourteen (14) feet per lane (exclusive of any medians) if from a non-residential or multifamily residential use onto any type of street, and
      - 2) Twenty-four (24) feet total if from a residential major subdivision onto any type of street.
      - 3) Twelve (12) feet for an individual residential driveway onto a local street and fourteen (14) feet for one and two-family residential driveways onto arterial or collector streets.
    - ii) Design and Construction of the Parking Lot Entrance Drive. For every new or converted multi-family, commercial, industrial and quasi-public use, the following standards shall apply:

- 1) Length of entrance drive to be kept free of parking maneuvers (backing up, three-point turns, initial parking) shall meet the requirements of *Table 7.5: Parking Lot Drive Length*.
  - 2) Each ingress or egress aisle/driveway shall have a minimum width as identified in *Table 7.1: Parking Dimensions*, dependent on the angle of parking. Each aisle/driveway shall be so designed so as to provide for adequate turning and maneuvering. Each ingress or egress aisle/driveway shall be improved with hard, dust free surface materials (excluding gravel) from the street apron to the entrance of the parking area.
  - 3) There shall be no more than two (2) access ways providing for ingress or egress on any one street unless for good cause shown and approved by the City Engineer.
  - 4) Ingress and egress driveways shall not be used to meet the requirements of *Table 7.3: Minimum Parking Space Requirements* as stated in this section and thereby block the reasonable flow of vehicles to parking spaces. Parking arrangements within ingress and egress driveway areas shall be approved by the Zoning Board of Appeals or City Council.
- iii) Travel Direction. The direction of travel for vehicles using entrances shall be as follows:
- 1) All entrances providing access to a public right-of-way from all lots used for nonresidential or multifamily development shall be designed so that vehicles are traveling in a forward direction when entering and leaving.
  - 2) In no case may any entrance for any use, except residential uses, be designed to require a vehicle to back onto any arterial or collector street.
- iv) Shared Entrances and Drives. Shared entrances and drives are encouraged for all uses in all zoning districts, specifically for any multifamily residential or nonresidential uses accessing a Major Collector or Arterial street.
- 1) Access Easements. All shared entrances and drives shall be constructed only in appropriate access easements. Easements must be recorded before usage commences.
  - 2) Required Documentation. A permanent documentation of any shared entrance and drive agreement must be signed by all involved property owners. The permanent written agreement shall include, but is not limited to the following items: maintenance, snow removal, ownership, and liability. The agreement, which can be amended and assigned shall be reviewed and approved by the City Engineer and duly recorded with the County Recorder. Any changes to the agreements must be accomplished with the consent of the Community Development Director. A copy of the agreement shall be retained for the files of the Planning & Zoning Commission. The agreement shall be recorded prior to the issuance of the occupancy permit.

Table 7.5: Parking Lot Entrance Drive Length	
Parking Spaces	Distance in Feet
1-39	20
40-99	40
100-300	60
300 or more	60, plus 20 additional for each 500 additional parking spaces

- v) Internal Drives. Internal drives may be public or private streets that are part of the hierarchy of travelways in multifamily and commercial subdivisions, providing access to and connecting the main entrance drive, parking lots and outparcels.
    - 1) Commercial Area Internal Linkages. All uses located in a commercial zoning district shall provide interior drives that allow access between existing and proposed commercial uses on adjacent properties.
    - 2) The internal road minimum width shall be twenty (20) feet for multifamily and nonresidential uses and districts.
    - 3) The interior drives may be required to be curbed, provide pedestrian access and landscaping.
    - 4) Cross-Access Required. The drives must be designed as a single two-way drive or a pair of one-way drives that provide access between the parking lots and interior drives of all adjoining commercial uses.
    - 5) Separation. Interior drives providing cross-access between adjacent parcels shall be separated from the right-of-way of any such street by a minimum distance specified by the City Engineer (based on the vehicle stacking requirements of the entrance(s) to the property from the public street).
  - vi) Curbs. All entrances and interior drives for property used for purposes other than agriculture, single-family residential, or two-family residential shall generally be completely curbed. Curbing shall not be required if, in the opinion of the City Engineer, the drainage system for the property shall be best served if curbs were not present.
  - vii) Driveway Separations. Driveway locations shall conform to the requirements for separation in *Chapter 34 – Subdivisions* of the *City of Dallas Code of Ordinances*.
- 3) MODIFICATION. The Zoning Board of Appeals and City Council shall have the authority to modify any of the requirements of this section in accordance with *Subsection 2.04 – Zoning Board of Appeals* and *Section 2.06 – City Council*.

#### **Sec. 7.04 – SIGHT VISIBILITY**

---

- 1) Sight Visibility Triangle
  - a) All properties, with the exception of those located in the Central Business District (CBD), shall maintain an area (the “sight visibility triangle”) at every intersection of an adjoining street with other streets and entrance drives. The sight visibility triangle shall be free of structures, vegetation, signs (other than street signs), fences, and other opaque or partially opaque objects between a height of two (2) and eight (8) feet measured from the nearest top-of-curb (or edge of pavement where curbs are not present).
  - b) The Sight Visibility Triangle shall be determined by a diagonal line connecting two points measured twenty-five (25) feet from the intersection of residential or local street / entrance drive lines, and fifty (50) feet from the intersection of arterial or collector street lines, or in the case of a rounded property corner, from the intersection of the street right-of-way lines extended. These standards shall not apply to official warning signs or signals necessary to the public safety.
- 2) Median and Intersection Visibility. No fence, wall, sign, hedge, tree or shrub planting, or other similar item which obstructs sight lines and elevations between two (2) and eight (8) feet above the street shall be placed within any median area within one-hundred (100) feet of an intersection. No walls, rocks, or boulders larger than two (2) feet in any dimension shall be placed in the median.

- 3) Stop Sign Visibility. No trees shall be planted in any portion of a public street right-of-way within one-hundred fifty (150) feet of a stop sign. Required street tree plantings shall be planted outside of the right-of-way.

Figure 7.2: Sight Visibility Triangle Diagram

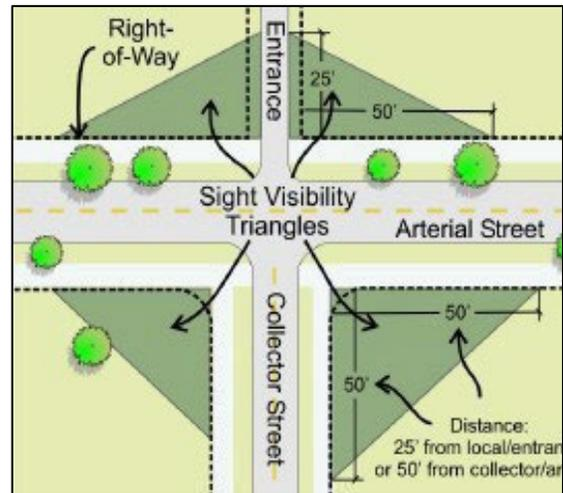

#### Sec. 7.05 – LANDSCAPING STANDARDS

- 1) **PURPOSE.** The purpose of this section is to provide minimum standards for landscaping that visually enhances development, defines circulation routes, reduces heat and glare in parking areas, and provides screening between incompatible land uses.
- 2) **APPLICABILITY.** This section shall apply to new property development and any expansion of existing legally conforming sites or structures that exceeds thirty-five percent (35%) in conformance with *Section 1.04 – Applicability and Compliance*.
- 3) **GENERAL REQUIREMENT FOR SUBMITTAL.** Any property to which this section applies shall submit a landscape plan as part of the Development Plan or Plat review process. Landscape plans shall be prepared and sealed by a professional landscape architect registered in the State of Georgia, unless waived by the Director. The landscape plan shall contain the following information:
  - a) Plans shall be prepared on 24"x36" sheets at a scale no less than 1" = 50' to indicate all types of proposed landscaping improvements and shall include the following minimum information:
    - i) North arrow and scale.
    - ii) The name of applicant/owner.
    - iii) The name, address and phone number of the person or firm responsible for the preparation of the plan.
    - iv) The dates the plans are submitted and/or revised.
    - v) All existing and proposed buildings and other structures, paved areas, planted areas, underground utilities, utility poles, fire hydrants, light standards, signs, fences and other permanent features to be added and/or retained on the site.
    - vi) All existing plant material to be removed or retained and all new landscaping materials to be installed.
    - vii) All existing and proposed streets, sidewalks, curbs and gutters, railroad tracks, drainage ditches and other public or semi-public improvements within and immediately adjacent to the site.

- viii) All property lines and easements.
  - ix) Any other information which is deemed appropriate by the Director.
  - x) Details shall be shown for the planting of the types of trees, shrubs and ground cover within the buffer yard or landscaped area.
  - xi) North arrow and scale.
  - xii) The name of applicant/owner.
  - xiii) The name, address and phone number of the person or firm responsible for the preparation of the plan.
  - xiv) The dates the plans are submitted and/or revised.
  - xv) All existing and proposed buildings and other structures, paved areas, planted areas, underground utilities, utility poles, fire hydrants, light standards, signs, fences and other permanent features to be added and/or retained on the site.
  - xvi) All existing plant material to be removed or retained and all new landscaping materials to be installed.
  - xvii) All existing and proposed streets, sidewalks, curbs and gutters, railroad tracks, drainage ditches and other public or semi-public improvements within and immediately adjacent to the site.
  - xviii) All property lines and easements.
  - xix) Any other information which is deemed appropriate by the Director.
  - xx) Details shall be shown for the planting of the types of trees, shrubs and ground cover within the buffer yard or landscaped area.
- 4) APPROVAL.
- a) No site or Development Plan required under this Zoning Ordinance shall receive secondary approval unless a buffer yard and landscape plan has been submitted and approved.
  - b) No final approval of the Land Disturbance Permit shall be granted unless the following criteria are fully satisfied with regard to the approved buffer yard and landscape plan:
    - i) Such plan has been fully implemented on the site; or
    - ii) Such plan, because of seasonal conditions, cannot be implemented immediately, but has been guaranteed by a postponed improvement agreement in accordance with *Subsection 7.05(5)(h) – Assurance of Installation/Completion*.
- 5) GENERAL LANDSCAPING STANDARDS. Buffer yard and landscape materials shall consist of the following items as indicated below. The proposed landscape materials should complement the form of the existing vegetation, as well as the development's general design and architecture. The cultural conditions (shade, sun, moisture, and location of planted material) should be considered in selecting plant materials.
- a) Maintenance of Landscaping and Buffer yards. All landscape materials shall be installed and maintained according to accepted nursery industry procedures.
    - i) The owner of the property shall be responsible for the continued property maintenance of all landscaping materials and buffer yards, and shall keep them in a proper, neat and orderly appearance, free from refuse and debris at all times.
    - ii) All unhealthy or dead plant material shall be replaced within one (1) year, or by the next planting period, whichever comes first.
    - iii) Violation of these installation and maintenance provisions shall be grounds for the Community Development department to: fine the owner of the property in violation of the

conditions of the Improvement Location Permit; require replacement of the landscape material; or institute legal proceedings to enforce the provisions of this section. Landscape materials are intended to grow, spread and mature over time. Landscaping materials used to fulfill requirements of this chapter may not be topped or otherwise treated so as to reduce overall height. Pruning, limbing-up, topping, and other inhibiting measures

including removal may only be practiced to ensure the public safety or to preserve the relative health of the material involved.

- b) Buffer yard and Landscaping Establishment. Once the landscape plan has been approved by the Planning & Zoning Commission or its designee and established by the owner, it may not be used, disturbed or altered in any way that would decrease its effectiveness for any purpose.
- c) Earthen Mounds. Earth mounds shall be physical barriers that block or screen the view, similar to a hedge, fence or wall. Mounds shall be constructed using approved fill and with a maximum slope of 3:1 (run:rise) and planted with proper and adequate plant materials to prevent erosion. A difference in elevation between areas requiring screening does not constitute an existing earth mound and shall not be considered as fulfilling any screening requirement.
- d) Plant Material. Artificial plants are prohibited. All plant materials shall be living plants and shall meet the following requirements. Plant materials used in conformance with the provisions of this chapter shall conform to the standards of the American Association of Nurserymen and shall have passed any inspections required under State regulations.
- e) Ground Cover. Any part or portion of a nonfarm parcel that is not used for structures, loading or parking spaces, sidewalks, etc., shall be landscaped or left in a natural state that complies with the applicable ordinances of the City of Dallas. If landscaped, it shall be planted with an all- season ground cover and with trees and shrubs in accordance with the requirements of this Ordinance and in keeping with the natural surroundings.
- f) Preservation of Existing Vegetation. Any existing vegetation that is retained, and that meets the species and location requirements of this section, may be counted towards fulfilling the minimum landscaping requirements, subject to the approval of the Community Development Director. No construction activity of any kind shall take place within the area defined by the drip- line of any vegetation that is to be retained and counted as fulfilling these requirements.
  - i) Prohibition of Clear Cutting. Clear-cutting is defined as: The removal of trees from a forested area to the extent that there is a clear danger of soil erosion and depositing of eroded soil upon adjacent land, public roads, private roads, or into adjacent waterways. The removal of all trees from a forested area at one time, without regard to species, quality, age or spacing shall be deemed clear-cutting. Clear cutting of trees shall be prohibited other than for the following areas and purposes, all of which must be described to the City Engineer on a drawing previous to start of clearing:
    - (1) For the placement and maintenance of a building within thirty feet (30') of each exterior wall,
    - (2) For the installation of a private septic system,
    - (3) A twenty-foot (20') wide (or width as allowed by other regulation) path for construction of a roadway from a public road or easement to the principal.
  - ii) Protected Trees. Consistent with the expressed purposes of this subsection, all persons shall make reasonable efforts to preserve and retain any existing, healthy, self-supporting trees, referred to as "protected trees." The minimum size of trees to be protected: deciduous trees

- six (6) inch caliper; evergreen trees - eight (8) inch caliper; and ornamental trees - two (2) inch caliper. No person shall take out, destroy, cause to be destroyed, move or remove any protected tree in preparation for development activity without first obtaining a Land Disturbance Permit from the Community Development department.
- (1) To further encourage the preservation of existing trees, each protected tree that is preserved and is greater than eight (8) inches in caliper may be counted toward the required landscape materials at a rate of two (2) required shade or evergreen trees or four (4) required ornamental trees. Preserved trees may not count toward the caliper inches required for mitigation of any trees removed.
- (2) Exemptions. The requirements of this subsection shall be followed except:
- (a) During a period of emergency, such as a tornado, ice storm, flood or any other such extreme act of nature;
  - (b) If the failure to remove a tree would constitute an imminent danger to the environment, property, public health, safety, or welfare due to the hazardous or dangerous condition of such tree;
  - (c) For necessary tree removal by a public agency or utility company within plotted or dedicated utility easements;
  - (d) In an area upon which a permanent structure is located or will be located within a lot building area for all zoning districts;
  - (e) With respect to trees on developed single-family lots;
  - (f) With respect to trees of less than twelve (12) caliper inches on all lots less than 20,000 sq. ft.;
  - (g) With respect to dead, substantially injured, diseased or damaged trees;
  - (h) Government agencies, tree farms, nurseries and agricultural uses shall be exempt from this subsection provided tree removal is consistent with normal and regular business activity.
- (3) Requirements for Development Plans. All applications for a Land Disturbance Permit or Development Plan Review that will require removal of protected trees shall include a protected tree plan or indicate on the demolition, grading and landscape plans the following:
- (a) A scale map or a plot plan showing the proposed development and noting the location of all protected trees. Tree stands may be outlined giving species and category of trees.
  - (b) Notations regarding which protected trees are to be removed, replaced, or are requested to be counted toward landscaping requirements.
  - (c) Methods of protection.
- g) Measurement Standards. All new trees required to be planted by this Ordinance shall be measured as follows:
- i) All broadleaf / deciduous trees shall be two and one-half (2½) inches in diameter (DBH-Diameter at Breast Height) at the time of planting, measured at six (6) inches above the root ball.
  - ii) All evergreen conifers shall be four (4) feet in height at the time of planting, measured from the top of the root ball.
  - iii) All shrubs shall be twenty-four (24) inches in height at the time of planting, measured from

ground level.

- h) Assurance of Installation/Completion. Plant material used for buffer yards, medians, entrances, ponds, or street or subdivision perimeter landscaping shall be designated as “Common Area” or as a landscape easement on the landscape plan(s), and shall be installed prior to the recording of the plat of the subdivision. A final Certificate of Occupancy shall not be issued until all landscaping shown on the landscape plan has been installed. A temporary Certificate of Occupancy may be issued for the property for a period of up to six (6) months as weather conditions permit landscape installation, provided that the developer shall submit a financial guarantee in the amount of one-hundred thirty-five percent (135%) of the installed cost of landscaping when planting has to be delayed.
  - i) Bonding. The applicant shall also have the option of posting a bond equal to one-hundred fifty percent (150%) of the material and installation costs identified on the plan if the installation of buffer yard and landscaping materials are to be completed at the end of a project. This bond will permit the City to contract the installation of the approved landscape plan, with the applicant’s landscape contractor, at the required “prevailing wage rate” should the applicant fail to install the landscape plan within one (1) complete growing season. The “Prevailing wage rate” is the rate at which the City must pay a contractor to provide services for the City. If the applicant desires bonding, the applicant shall revise the cost annually to account for increases in costs of labor and materials.
  - j) Utility Easement Conflicts. Required plant material shall be located in areas exclusive of drainage and utility easements and overhead utilities. Plant material shall not be placed in the road/street right-of-way without permission from the City Engineer.
- 6) PARKING AREA LANDSCAPING
- a) Perimeter Landscaping for Off-Street Parking Areas. All parking lots, including parking spaces (excluding interior drives and loading/unloading areas), shall be separated from all public or private street rights-of-way by a landscape screen that is a minimum of twenty (20) feet in width. Parking areas adjacent to other developed parcels shall require a planting area that is a minimum ten (10) feet in width. Trees shall be provided for interior drives per *Subsection 7.05(8) – Street Tree Planting Requirements*. Screening may consist of any of the following options or a combination:
    - i) Planting. A minimum of one (1) tree shall be provided for every thirty (30) linear feet of landscaped area. The trees may be a combination of deciduous and evergreen. The tree requirement may be reduced or eliminated if street trees are provided per *Subsection 7.05(8)* and are within thirty (30) feet of the edge of the parking area. In addition, a minimum of one (1) shrub shall be provided at a minimum of every three (3) feet in order to form a continuous screen a minimum of thirty-six (36) inches high within two (2) years of planting. The spacing may be wider than three feet depending on shrub selection and with approval by the Director. A minimum of fifty percent (50%) of the required shrubs shall be evergreen; or
    - ii) Landscape Berm. A landscaped berm that is a minimum of three (3) feet in height shall be provided along the length of the landscaped area. Trees shall be provided and shrubs where the berm tapers to less than thirty-six (36) inches to maintain a continuous screening height of thirty-six (36) inches.
  - b) Perimeter Landscaping for Off-Street Parking Lots adjacent to Residential Uses or Zoning Districts. Parking lots shall be screened adjacent to the residential use or zoning district to a minimum

height of four (4) feet in accordance with the appropriate buffer yard as determined by *Table 7.8: Applicable Buffer Yard Types* and *Table 7.9: Buffer Yard Types Description*.

- c) Interior Landscaping for Off-Street Parking Areas. Parking areas (including loading, unloading and storage areas) containing more than twenty-five (25) vehicular parking spaces, shall provide interior landscaping in addition to the previously required perimeter landscaping. Interior landscaping may be contained in peninsulas or islands.
- i) Landscaping area. Five percent (5%) of vehicular use area shall be landscaped. However:
    - (1) Minimum area. The minimum landscape area permitted shall be one-hundred eighty (180) square feet with trees planted a minimum of four (4) feet from the curb or the edge of the pavement;
    - (2) Distribution. The required landscape areas are to be adequately dispersed throughout the off-street parking areas; and
    - (3) Ground Cover. Shrubs, ground cover, and other live plant material shall be used to fill the rest of the interior landscaped area.
  - ii) Maximum Spaces. The maximum number of permitted parking spaces is the minimum required number of spaces plus ten percent (10%).
    - (1) For proposed parking lots of more than one-hundred (100) parking spaces that exceed the maximum number of permitted spaces (see *Subsection 7.02(26)a* above), the Zoning Board of Appeals may increase the minimum amount of required interior landscaping by five percent (5%), and may require that the additional paved area be constructed with pervious pavement.
  - iii) A minimum of one (1) broadleaf/deciduous tree providing shade at maturity shall be provided for every one-hundred eighty (180) square feet of landscaped area. To obtain minimum desired coverage, the maximum spacing between required canopy trees shall be one-hundred (100) feet.
    - (1) As trees mature, trees shall have a clear trunk to at least five (5) feet above the ground, and the remaining plant material shall be maintained not to exceed three and one-half (3½) feet in height.
  - iv) Vehicle overhang. Parked vehicles may hang over the interior landscaped area no more than two (2) feet, as long as concrete or other wheel stops are provided to insure no greater overhang or penetration of the landscaped area.
- 7) RESIDENTIAL LANDSCAPING. Landscaping as stated below shall be required for all single- and multifamily subdivision development, and developments under the horizontal property regime prior to the issuance of a Certificate of Occupancy. Extensions of up to one-hundred twenty (120) days may be granted to take advantage of optimal planting conditions.
- a) Major Subdivision Perimeter Landscaping. Landscaping plant material shall be provided on the perimeter of major subdivision development when adjacent to a public right-of-way as follows:
    - i) A twenty (20) foot wide landscape area adjacent to the road or right-of-way shall be provided. The landscaping shall be designated as “common area” or placed in a landscape easement. All attempts should be made to avoid conflicts with drainage and utility easements that would prevent the installation of landscape materials in accordance with the Ordinance.
    - ii) Trees shall be provided at a minimum rate of five (5) trees per one-hundred (100) linear feet of perimeter planting. Trees shall be staggered throughout the planting area and no two (2)

- trees shall be closer than twenty (20) feet. Perimeter plantings shall be a roughly equal mix of deciduous canopy trees and evergreen trees. Up to twenty-five percent (25%) of the trees may be of the ornamental type for color and accent.
- iii) Shrubs shall be provided at a minimum rate of ten (10) per one-hundred (100) linear feet of perimeter planting. Medium to large shrubs are encouraged in the twenty (20) foot wide landscape area.
  - iv) Calculation. Trees and shrubs shall be prorated and rounded up to the nearest whole number for every foot over the initial one-hundred (100) feet.
  - v) Planting Pattern. It is suggested that the required trees and shrubs be at least fifty percent (50%) evergreen, planted in clusters or irregular patterns, and shall be combined with perimeter fences, walls, or mounds as detailed below.
- b) Subdivision Perimeter Fences / Walls / Mounds. One of the following landscaping options shall be required in addition to the plant material specified above in *Subsection 7.05(7)*.
- i) Decorative perimeter fences/walls shall be combined with plant material and shall be constructed of masonry, stone, wood, or decorative metal. Fences/walls constructed of synthetic materials that simulate natural materials will also be considered. Fences/walls shall be at least thirty-six (36) inches in height, but not over seventy-two (72) inches in height. Transparent (open) or opaque fences/walls may be used. Fencing/walls may only be provided by the developer and only located in the area designated as “common area” or “landscape easement.” Landscaping may be placed on the right-of-way side of the fence/wall, outside of the public right-of-way.
  - ii) Mounds. Mounds shall be combined with plant material, as described above, and may include fencing. Mounds shall be located in an area designated as “Common Area” or “landscape easement.” Mounds shall be a minimum of three (3) feet in height. Maximum side slope shall not exceed a three to one (3:1) ratio. Continuous mounds (levee look) are not permitted.
- c) Common Area. Where a Common Area is designated on the plat or Development Plan of a residential project, a Property or Homeowner’s Association shall be formed and shall be required to provide necessary maintenance to said common areas as per *Subsection 7.13(3)(h)*.
- d) Individual Lot Landscaping. The minimum landscape package for front and side yards shall be consistent with *Table 7.7: Individual Residential Lot Landscaping* and the following:
- i) The minimum number of shrubs required is a total for the side and front yard combined, not for each yard individually.
  - ii) Lots that have existing trees in the front yard that meet the required minimum shall not be required to plant additional trees. In order for the existing trees to qualify as an existing tree it must be a minimum size of two (2) inch caliper measured six (6) inches above the existing ground elevation at the base of the tree and be part of the finish landscape package upon completion of the residence and the final lot grading.
  - iii) In addition to the above requirements, landscape packages for corner lots shall include a street side-yard (which shall be defined as the yard fronting the street on the side of the house that does not face the street) plan of one (1) evergreen tree and twelve (12) shrubs.
  - iv) All trees shall be planted such that upon maturation the branches and limbs shall not interfere with the adjacent property use. Any tree becoming such a nuisance shall be trimmed or cut back to eliminate the nuisance by the property owner.

- v) Plant material shall be placed out of the Sight Visibility Triangle at intersections as per *Section 7.04 – Sight Visibility*. There should be a clear visibility zone between thirty-six (36) inches and nine (9) feet maintained by the property owner.
- vi) Trees shall not be planted in the right-of-way.
- vii) Townhome developments that feature multiple side-by-side units on one parcel shall adhere to the standards within *Table 7.7: Individual Residential Lot Landscape* for the TH Zone.

Zoning District	Number of Trees	Minimum Number of Shrubs	Front Yard Sod
R-1	3	12	no
R-2	2	10	yes
R-3	2	10	yes
TH	2	10	yes

For PUDs, single-family residential developments shall comply with the requirements of the zoning district most closely reflective of the density of development contained in this subsection.

- 8) **STREET TREE PLANTING REQUIREMENT.** The following are street tree planting requirements for all districts:
- a) **Requirements.** Trees along public streets shall be planted in such a manner, type, quality and location as approved by the City Council and the same requirement shall apply to all streets with or without undeveloped frontage.
    - i) One (1) street tree shall be placed every forty (40) to sixty (60) feet outside of the right-of-way per the City Engineer, but within five (5) feet of the edge of the right of way in order to contribute to the streetscape.
    - ii) The tree location is to be at least twenty (20) feet from fire hydrants or utility poles.
    - iii) A suitable tree is to be used when planting under or within ten (10) lateral feet of overhead utility wires which will not affect the transmission or service of overhead utility services, subsurface drains, driveways, sidewalks, and underground utilities. Refer to *Table 7.12: Trees for Planting on Streets and Highways that Minimize Conflict with Overhead Utilities* for suitable trees.
    - iv) The developers shall be required to maintain the trees for one (1) year after the trees are planted and shall replace any tree which dies within such one (1)-year guarantee period. Upon completion of a street planting, the landscape contractor shall contact the Director or his/her designee for a preliminary inspection. The guarantee period shall begin after the approval by the Community Development Director. A final inspection shall be made at the end of the guarantee period. All trees not exhibiting a healthy, vigorous growing condition, as determined by the City’s inspection, shall be promptly replaced at the expense of the developer.
  - v) **Replacement Trees.** A person who removes, damages or causes to be removed a public tree from tree lawn or other public place shall be required to replace the tree at his or her own expense. The replacement tree shall be a species from *Table 7.13: Trees for Planting on*

*Streets, Highways, and Parking Lots or Table 7.14: Trees for Planting on Streets and Highways that Minimize Conflict with Overhead Utilities.*

- 9) RETENTION POND LANDSCAPING. Shrubs and emergent vegetation are encouraged to be planted on pond perimeters. These plants may be exempt from minimum required plant sizes set forth in *Subsection 7.05(5)*. The use of this plant material is more desirable than nonnative manicured turf in order to provide color, filter runoff, limit waterfowl, and improve water quality.
- a) Choose plant material that is native to Georgia.
  - b) Pond edge seed mixes are available from local suppliers. Pond edge landscaping may also be established from seed.
  - c) Maintenance shall be consistent as it may take up to three (3) years to mature.
  - d) Plant denser ground covers around outfall and drainage outlets to control erosion and stabilize the ground.

10) WASTE CONTAINERS/ RECYCLING CONTAINERS / SERVICE STRUCTURES SCREENING REQUIREMENTS.

With the exception of single-family residential districts, no owner, tenant or occupant of any lot in any district may store, place, or keep, or permit to be stored, placed or kept on that lot, any combination of dumpsters, compactors, grease dumpsters or any other waste or garbage containers (hereinafter referred to as “containers”), that exceed a total of one-hundred twenty (120) gallons in capacity, outside an enclosed building, except for collection purposes as is otherwise permitted in this Ordinance, unless the following conditions are met.

- a) The containers shall be located on a concrete pad that is enclosed by a three-sided structure constructed of masonry construction or wood sufficient to provide complete visual screening of the containers to a height of twelve (12) inches above the top of the containers. The unit shall be constructed with materials similar to the principal structure. The structures shall not be located closer than twenty (20) feet from any dwelling on an adjacent residential lot. The structure shall not project into or be located on a front or side yard. It may be located in a rear yard but shall be not less than five (5) feet from any rear or side lot lines. On corner lots the enclosure can sit no closer to the street than the building itself.
- b) Any service structure that can be seen from the first floor of a residence or from any street shall be screened. Structures may be grouped together; however, screening height requirements shall be based upon the tallest of the structures. “Service Structures” shall include, but not be limited to: loading docks, propane tanks, dumpsters, electrical transformers, utility vaults which extend above ground, ground-mounted utility equipment and any electrical or other equipment or elements providing service to a building or a site.
  - i) Location of screening. There shall be a continuous planting, hedge, fence or wall of earth, having one-hundred percent (100%) opacity, which would enclose any service structure on all sides, unless such structures must be frequently moved or accessed, in which case screening on all but one side is required. The average height of the screening material shall be six (6) feet or one (1) foot greater than the height of the enclosed structure, whichever is greater, but shall not, in any case, be required to exceed ten (10) feet in height.
    - (1) Whenever a service structure is located next to a building wall, perimeter landscaping material, or off-street parking area landscaping material, such walls or screening material may fulfill the screening requirement set out in *Subsection 7.05(6)*. Whenever

service structures are screened by plant material, such material may count towards the fulfillment of required interior or perimeter landscaping. Whenever a service structure is screened by a wall or fence, such wall or fence shall be constructed of the same materials as the building which it services.

- ii) Curbs to protect screening material. Whenever screening material is placed around any dumpster or waste collection unit which is emptied or removed mechanically on a regularly occurring basis, a curb to contain the placement of the container shall be provided within the screening material on those sides where there is such material. The curbing shall be at least one (1) foot from the material and shall be designed to prevent possible damage to the screening when the container is moved or emptied.
- c) If the opening of the unit is in sight of the public right-of-way, it shall be covered by a door constructed of a solid material which shall remain closed when not in use, and it shall be maintained in good condition.

11) MECHANICAL EQUIPMENT BUFFERING STANDARDS. Mechanical equipment materials and buffering standards applicable to the multifamily residential and nonresidential zoning districts:

- a) Ground Level. All outdoor storage areas for completed products manufactured on-site, production materials, building-mounted utilities, outdoor refrigeration units and mechanical equipment located on the ground shall be screened consistent with the following requirements. In no instance shall this be interpreted as applying to merchandise for sale that is temporarily or seasonally placed outdoors.
  - i) Fencing. A minimum six (6) feet tall, one-hundred percent (100%) opaque fence of wood, brick, or stone construction shall completely screen the area from the view of public streets and adjacent properties. Opaque six (6) feet tall gates shall be provided to access the facility. The gates shall generally remain closed, except when immediate access to the area is required.
  - ii) Landscape Screening. Evergreen planting shall be provided around the exterior perimeter of the required fencing.
    - (1) Evergreen shrubs shall be a minimum of two (2) feet tall at the time of planting, and planted at a maximum of three (3) feet on center. Wider spacing may be permitted depending on the species and upon approval of the Director.
- b) Roof-mounted. All roof-top equipment, such as HVAC units, shall be screened from the view of all public streets by parapets, dormers, or other screens. The material of all such screens shall be consistent with the exterior materials used on the facade of the structure.

12) BUFFER YARD REQUIREMENTS. The following requirements shall pertain to buffering a new use from an existing adjacent use or district as described below. The purpose of these buffering and screening standards is to lessen the potential conflicts between the possible uses in one zoning district and those uses in adjacent districts through the use of setbacks and landscaping. The potential degree of conflict between the uses determines the extent of the buffer required.

- a) Applicability.
  - i) Screening areas shall be provided for the purpose of minimizing the friction between incompatible land uses and improving the aesthetic and functional quality of new development;

- ii) Where vegetative and/or topographic conditions that provide a natural screening and buffer exist prior to development of properties in question, every effort shall be made to retain such conditions. In such cases, additional screening may not be required, provided that provision is made for maintenance of such areas; and
  - iii) The City Council may waive the requirement for a wall, fence or greenbelt if equivalent screening is provided by existing or planned parks, parkways, and recreation areas or by topography or other natural conditions.
- b) Buffer Yard Standards. The buffer yard standards only apply along the property lines where the two dissimilar uses or zoning classifications meet as specified in *Table 7.8: Applicable Buffer Yard Types*. The required buffer yards shall be installed despite the presence of streets, alleys, and other features. Existing mature vegetation may be credited towards required buffering. When a dissimilar land use locates next to an established residential land use within the same zoning classification, buffering and screening standards per *Table 7.9: Buffer Yard Types Description* for Buffer Yard Type 2 shall apply.
- i) Responsibility. The developer or owner of the property being developed or otherwise changed in use is responsible for installing the buffer yard at the time of that development or change. The adjacent property owner shall not have to participate in installing the buffer yard.
  - ii) Buffer Yard Location. All required buffer yard areas shall be provided entirely on the subject property and shall be in addition to setbacks required by this Ordinance.
  - iii) Planting Location. Required buffer yard trees may be placed either at regular intervals or in irregular patterns representing a natural landscape. However, no two (2) buffer yard trees (excluding evergreen trees) shall be placed closer than twenty (20) feet to one another. No buffer yard or required landscape materials shall be placed within any easement, right-of-way, or septic field.
  - iv) Tree Size. All broadleaf / deciduous trees must have at least a two and one-half (2½) inch caliper measured at six (6) inches above the top of the rootball, and all evergreen conifers must be a minimum of four (4) feet in height measured from the top of the rootball when planted.
  - v) Ground Cover. All portions of the buffer yard not planted with trees, shrubs or other landscaped materials shall be covered with grass or other ground-covering vegetation. Landscaping stone or other non-vegetative surfaces may not be substituted for ground-covering vegetation unless otherwise approved by the Director.
  - vi) Application. No landscaping required by this section may be used to satisfy the minimum requirements of any other provisions of this Ordinance unless approved by the Director.
  - vii) Maintenance. All landscape materials must be properly maintained, and kept in a neat and orderly appearance, free from all debris and refuse.
    - (1) All plant material which is unhealthy or dead, in the opinion of the Community Development Director, shall be replaced by the end of the next spring or fall planting season.

(2) Landscape materials are intended to grow, spread and mature over time. Pruning, limbing-up, topping and other growth-inhibiting measures may only be used to ensure the public safety and/or health of the vegetation.

c) Buffer Yard Widths. The buffer yard requirement shall not be included as part of the minimum setback requirements unless approved by the Director. Plant material shall be selected from *Tables 7.13 - 7.20* unless approved by the Director.

13) MODIFICATION. The Planning & Zoning Commission, City Council or Zoning Board of Appeals shall have the authority to modify any of the requirements of this section in accordance with *Subsection 2.02(9)(a) ix*.

**Table 7.8: Applicable Buffer Yard Types**

		New Residential Development						New Commercial Development					New Industrial Development	
		R-1	R-2	R-3	TH	MF1	MF2	CBD	MXU	C-1	C-2	OMI	I-1	I-2
Existing Residential	R-1	-	1	1	2	3	3	3	3	3	4	3	4	4
	R-2		-	1	1	2	3	3	3	3	4	3	4	4
	R-3			-	1	2	3	3	3	3	4	3	4	4
	TH				-	1	2	3	3	3	3	3	4	4
	MF1					-	1	2	2	2	3	2	3	4
	MF2						-	2	2	2	3	2	3	4
	CBD							-	1	1	1	1	3	4
Existing Commercial	MXU							-	1	1	1	3	4	
	C-1								-	1	1	2	4	
	C-2									-	1	2	4	
	OMI										-	2	4	
Existing Industrial	I-1											-	3	
	I-2												-	

When a dissimilar land use locates next to an established residential land use within the same zoning classification, buffering and screening standards per Table 7.7: Buffer Yard Types Description for Buffer Yard Type 2 shall apply.

Table 7.9: Buffer Yard Types Description	
<b>Type 1</b>	Buffer width - Ten (10) feet. Any combination of materials selected from the Landscape Materials Categories listed in Table 7.10: Unit Value of Landscaping Material which equals or exceeds a unit value of 3.0 for each one hundred (100) linear feet, along any exterior roadway, and unit value or 2.0 for each one hundred (100) linear feet of adjoining property (developed or undeveloped), provided that at least fifty percent (50%) of the unit value shall be derived from deciduous shade trees (overstory).
<b>Type 2</b>	Buffer width - Twenty (20) feet. Any combination of materials selected from the Landscape Materials Categories listed in Table 7.8: Unit Value of Landscaping Material which equals or exceeds a unit value of 4.0 for each one hundred (100) linear feet, along any exterior roadway, and unit value or 3.0 for each one hundred (100) linear feet of adjoining property (developed or undeveloped), provided that at least twenty-five percent (25%) of the unit value shall be derived from deciduous shade trees (overstory). A minimum fifty percent (50%) of the trees and shrubs shall be evergreen species. Earthen mounds are encouraged to gain additional height.
<b>Type 3</b>	Buffer width - Thirty (30) feet. Any combination of materials selected from the Landscape Materials Categories listed in Table 7.8: Unit Value of Landscaping Material which equals or exceeds a unit value of 5.0 for each one hundred (100) linear feet, along any exterior roadway, and unit value or 4.0 for each one hundred (100) linear feet of adjoining property (developed or undeveloped), provided that at least ten percent (10%) of the unit value shall be derived from Deciduous Shade Trees (overstory) or deciduous ornamental trees (understory). A minimum fifty percent (50%) of the trees and shrubs shall be evergreen species. Earthen mounds shall be incorporated into the buffer yard design.
<b>Type 4</b>	Buffer width - Seventy-five (75) feet. The buffer yard shall contain an opaque fence/wall a minimum of eight (8) feet in height. An undulating earthen mound may be substituted but the average maintained height with plant material shall be eight (8) feet. Any combination of materials selected from the Landscape Materials Categories listed in Table 7.8: Unit Value of Landscaping Material which equals or exceeds a unit value of 5.0 for each one hundred (100) linear feet, along any exterior roadway, and unit value or 4.0 for each one hundred (100) linear feet of adjoining property (developed or undeveloped). Seventy-five percent (75%) of the unit value shall be derived from evergreen trees. Fifty percent (50%) of required landscaping shall be on the adjacent property side of the fence.

Table 7.10: Unit Value of Landscape Material	
Time of Planting	Value
Diciduous Tree (Overstory) (2 1/2" caliper)	0.75
Evergreen Tree (9' tall)	0.75
Deciduous Ornamental Tree (Understory) (1 1/2" caliper)	0.50
Evergreen Tree (4' tall)	0.50
Evergreen Shrub - Narrow Spread (4" tall)	0.25
Hedge Plant (24" - 30" tall)	0.05
Earthen Mound (3' tall)	0.50
Earthen Mound (6' tall)	1.00
Earthen Mound (9' tall)	1.50

**Sec. 7.06 – TREE CONSERVATION**

1) TREE DENSITY REQUIREMENTS

- a) Use of tree units. The landscaping requirements of this Article regarding the preservation or planting of trees is expressed in terms of "tree units" rather than the number of trees or tree canopy. This approach provides the applicant with wide latitude of choice as to the number and

sizes of trees to be planted, and their distribution following aesthetic landscaping practices, while achieving a common standard on all properties.

- b) **Establishment of tree unit values.** The diameter of a tree's trunk establishes the "tree unit" value of an existing tree, as shown on *Table 7.11: Tree Units for Existing Trees*, or for a newly planted tree as shown on *Table 7.12: Unit Value of Landscape Material*.
  - i) The values assigned to trees of the same size are different for existing and new trees, as indicated in the table. One "unit" is not the same as one "tree."
  - ii) Actual tree diameters or calipers are to be rounded to the nearest whole number for the calculation of tree unit values (e.g., 4.5 inches in diameter = 5 inches).

<b>Table 7.11: Tree Units for Existing Trees</b>			
<b>Tree Diameter</b>	<b>Tree Units</b>	<b>Tree Diameter</b>	<b>Tree Units</b>
2	0.0	21	4.8
3	0.0	22	5.0
4	0.6	23	5.2
5	0.8	24	5.4
6	1.0	25	5.6
7	1.2	26	5.8
8	1.3	27	6.0
9	1.5	28	6.2
10	1.7	29	6.4
11	1.9	30	6.6
12	2.1	31	7.2
13	2.3	32	7.8
14	3.0	33	8.4
15	3.3	34	9.0
18	4.2	37 or greater	12.0 + 1.0 each inch

Note: Minimum DBH to receive credit for existing tree is 4 inches.

<b>Table 7.12: Tree Units for New (Replacement) Trees</b>			
<b>Tree Diameter</b>	<b>Tree Units</b>	<b>Tree Diameter</b>	<b>Tree Units</b>
Seedlings	0.0	9	1.3
1	0.0	10	1.5
2	0.3	11	1.7
3	0.4	12	1.9
4	0.5	13	2.2
5	0.6	14	2.5
6	0.7	15	2.8
7	0.9	16	3.1
8	1.1	17+	3.5 + 0.5 for each

- c) Tree unit values for specimen trees or tree stands.  
 i) Specimen trees and specimen tree stands; defined.

**Specimen Tree** means any tree which qualifies for special consideration for preservation due to size, type and condition, as follows:

- 1) Any tree in fair or better condition which equals or exceeds the following Diameter at Breast Height (DBH) sizes:
  - a. 28-inch DBH—Overstory hardwoods such as oaks, hickories, yellow poplars, sweetgums, etc.
  - b. 12inch DBH—Understory small trees such as dogwoods, redbuds, sourwoods, etc.
  - c. 30-inch DBH - Pine trees (all species)
- 2) A tree in fair or better condition must meet the following minimum standards:
  - a. A life expectancy of greater than fifteen (15) years.
  - b. A structurally sound trunk, not hollow and having no extensive decay, and less than 20 percent radial trunk dieback.
  - c. No more than one major and several minor dead limbs (hardwoods only).
  - d. No major insect or pathological problem.
- 3) A lesser sized tree can be considered a specimen tree if it is a rare or unusual species, of exceptional or unique quality, or of historical significance, subject to approval of the Community Development Director or their designee.
- 4) A lesser size tree can be considered a specimen tree if it is specifically used by a builder, developer, or design professional as a focal point in a landscape project, subject to approval of the Community Development Director or their designee.

- ii) **Specimen Tree Stand** means a contiguous grouping of trees which has been determined to be of high value in the opinion of the Community Development Director or their designee. Determination is based upon the following criteria:

- 1) A relatively mature, even-aged stand.
- 2) A stand with purity of species composition or of a rare or unusual nature.
- 3) A stand of historical significance.
- 4) A stand with exceptional aesthetic quality.

- iii) The tree unit values shown in *Table 7.12: Tree Units for Existing Trees*, may be increased by 100% for an existing tree that meets the definition of a "specimen tree" or for a "specimen tree stand" as defined herein, provided that extraordinary measures as needed are taken to protect the tree and assure its survival. Such measures may include but are not limited to the provision of tree wells, retaining walls, aeration, or supplementary irrigation, as applicable to the site of the tree and as approved by the Director.

## 2) TREE DENSITY STANDARDS

- a) Tree Retention. On each property for which a Tree Preservation and/or Replacement Plan is required, existing trees shall be retained and new trees shall be planted such that the property shall attain or exceed a Tree Density Standard as follows:
- i) Residential – Sixteen (16) Tree Density Units per acre,
  - ii) Office/Commercial/Mixed-use – Sixteen (16) Tree Density Units per acre,
  - iii) Industrial – Sixteen (16) Tree Density Units per acre.
- b) Distribution. Trees, both existing and new, shall be reasonably distributed throughout the site, with emphasis on tree groupings to achieve aesthetic results following professional landscaping standards. Trees, including street trees, may be retained or planted for credit within a public street right-of-way.

- c) Trees in Stream Buffer. Trees located in a stream buffer may be counted toward fulfilling the Tree Density Standard provided the acreage within the stream buffer is included in the calculations used to fulfill the Tree Density Standard.
- d) Easement Exclusion. Properties possessing natural gas, petroleum or electric power transmission easements, or major sanitary sewer main (greater than 8 inches in diameter) or water main (greater than 16 inches in diameter) distribution easements, may exclude the land area contained in the easement from the total acreage of the property in fulfilling the Tree Density Standard provided that no improvements (e.g. parking lots, tennis courts, driveways, greenways, storm water detention facilities, etc.) are proposed within the easement. If any improvements are proposed within the easement, then the land area so used within the easement for the improvements, plus an additional 10-foot of land area surrounding the improvements, shall be included in the total acreage of the property to fulfill the Tree Density Standard.
- e) Lake and Pond Exclusion. Properties with a lake or pond may exclude the land area contained in the lake or pond from the total acreage of the property in fulfilling the Tree Density Standard.

### 3) TREE DENSITY STANDARD CALCULATION

The Tree Density Standard shall be calculated by summing the credits and dividing the sum by the total acreage of the project included within the limits of the permit application. For parcels larger than ten (10) acres, where more than sixty (60%) percent of the total lot area is being disturbed, the Community Development Director can authorize a collection of sample areas to assess the tree density threshold for a particular development or parcel. One 50'x50' sample area may be required for every three (3) acres of disturbed land, and must be demarcated, inspected, and approved by the Director as being a representative sample.

### 4) QUALIFIED TREE AND BUSH SPECIES TABLES

- a) The City Council shall maintain a list of tree species approved for conservation and planting within the city as well as those not recommended. The list shall be known as the city's Community Tree Species list, included as *Tables 7.13 through 7.20* of this chapter. The tree species list includes the mature size category of each species, notations on which species may be planted beneath utility lines, and other species characteristics.
- b) The list is maintained by the City Council and may change without notice to incorporate results of research and experience with individual species and is available from the Community Development Department.

### 5) PERMEABLE SURFACES UNDER TREE DRIPLINES

The minimum permeable surface area requirements under tree driplines are as follows.

- a) For conserved trees in residential zones no more than twenty (20%) percent of the dripline can be encroached upon by impermeable surfaces provided the remaining area is mulched.
- b) For planted trees in all zones the amount of permeable surface area required shall be based upon the mature tree size category on the Community Tree Species List, found in *Tables 7.13 to 7.20*, as follows:
  - i) Large trees: 640 square feet;
  - ii) Medium trees: 360 square feet;
  - iii) Small trees: 160 square feet.
- c) For planted trees the dripline shall be mulched.

## 6) TREE PROTECTION

- a) Conserved trees. All conserved trees shall be actively protected during the development process and passively protected throughout the life of the development. The entire tree, including the crown, trunk, and roots, and the critical root zone, shall be protected.
- b) Minimum tree protection measures. Active tree protection shall consist of, at a minimum, establishing a tree protection zone around each tree or grouping of trees by the installation of fencing at the outer edge of the dripline or Critical root zone, whichever is greater. Minimum tree protection measures for boundary trees, existing on adjacent properties, whose critical root zones extend onto the project site is mandatory.
  - i) No more than twenty-five (25) percent of a boundary tree's mature crown or one-third (1/3<sup>rd</sup>) of a young tree's canopy shall be removed in one season.
  - ii) Pruning of conserved trees should only be done by an ISA (International Society of Arboriculture) certified arborist.
  - iii) Tree protection fencing and tree protection area signs shall be installed after the issuance of a disturbance Permit and prior to any land disturbance activity or building activity.
    - (1) Tree protection fencing shall be four feet high, made of orange high-visibility polypropylene, and erected with sturdy wooden or metal posts around the tree protection zone. A heritage tree, or a significant species tree, as determined by the Director, may require increased protection. Methods and extent of increased protection will be as directed by the Director.
    - (2) Signs shall be fabricated out of a sturdy material, shall be waterproof, and contain the following legible text in English and Spanish: "TREE PROTECTION AREA, ENTRY PROHIBITED." The signs shall be a minimum of 8.5 × 11 inches, shall be placed on a sturdy post a minimum of thirty (30) inches off the ground, and shall be spaced a maximum of 50 feet apart.
    - (3) Tree protection fencing and signage shall remain in good condition throughout the development and construction processes, and shall only be removed after the final plat approval or a certificate of occupancy has been issued.
  - iv) Encroachment into the tree protection area shall result in the loss of Tree Density Unit credit for preserved trees.
  - v) The critical root zone within the tree protection area shall be mulched with a minimum of three inches and not more than five inches of organic mulch such as pine straw, wood chips, tree leaves, or compost, for a minimum of three years, or prior to issuance of the final certificate of occupancy for the project, whichever occurs last.
  - vi) The Community Development Director or their designee may require the installation of additional tree protection measures to insure survivability of conserved trees.
- c) Prohibited activities. Within the tree protection areas, without proper authorization or permit the following activities shall be prohibited:
  - i) Vehicle traffic or parking;
  - ii) Materials or equipment storage;
  - iii) Soil disturbance;
  - iv) Soil excavation;
  - v) Removal of topsoil;
  - vi) Trenching;
  - vii) Soil fill;
  - viii) Change in soil pH;
  - ix) Change in soil drainage;

- x) Equipment washouts or disposal (including concrete);
  - xi) Fires;
  - xii) Chemical or trash disposal;
  - xiii) Other activities harmful to the trees as determined by the Community Development Director or their designee;
  - xiv) Encroachment into tree save area; and
  - xv) Destruction or removal of trees.
- d) Planted trees. All planted trees shall be actively protected during the development process and passively protected throughout the life of the development. The entire tree, including the crown, trunk, and roots, and the critical root zone, shall be protected.
- e) Existing trees in construction zones. All trees that are outside the formal tree protection zone(s) as outlined in the Tree Protection and Replacement Plan and are equal to or greater than twelve (12) inches DBH, and are in areas where construction will occur inside the crown of the tree shall be required to have an enhanced protection program. In order to maximize the ability of the selected trees to survive construction the proposed program will include the following steps.
- i) The tree will be surveyed and located with the species and DBH noted and approximate crown diameter shown.
  - ii) Prior to the beginning of construction activities, the trees shall be inspected by a City Approved Arborist to determine their overall condition and ability to withstand construction activity around them.
  - iii) Should the City Approved Arborist determine that with a proper protection plan the tree would survive the construction activity the Arborist shall prepare a care plan for the tree. The plan may involve elements such as crown pruning, fertilization, irrigation, root pruning or other activities.
  - iv) The Contractor will be required to implement the Arborist's protection plan and to maintain the necessary activities to protect the tree until such time as the site construction is completed and accepted for maintenance by the property owner. The City Approved Arborist shall submit bi-weekly reports to the Contractor and the Department of Community Development during the construction process.
  - v) The owner of the property shall receive a twenty (20%) percent bonus credit for canopy coverage for all trees that are under the enhanced protection program.
  - vi) No land disturbing activity or construction activity, including, but not limited to, grading, digging, soil disturbance or other activity within the critical root zone of any boundary tree, is permitted that will deprive the boundary tree of continued viability as determined by a certified arborist.
  - vii) The following parameters shall be followed when determining boundary tree viability interference:
    - (1) CRZ/TPZ nineteen (19%) percent or less impact and protected by tree protection, no arboricultural prescription required.
    - (2) CRZ/TPZ twenty (20%) percent — thirty-three (33%) percent impact but protected by tree protection (no structural root plate impact) provide arboricultural prescription with a plan for review by the city.
    - (3) CRZ/TPZ twenty (20%) percent — thirty-three (33%) percent impact and structural root plate has impact/not protected.
  - viii) The builder/developer/construction site property owner must submit a boundary tree agreement signed by the tree owner/co-owner and notarized giving permission for the tree that has construction impact to be treated or removed (see Community Development

Department for the city boundary tree agreement). The minimum time length of the boundary tree agreement shall be three (3) years. The receipt for the paid arboricultural prescription and signed agreement will need to be submitted with the plans for review.

- 1) The builder/developer/construction site owner must make at least three attempts to contact the owner of the boundary tree to enact a boundary tree agreement. The first two attempts may be in person or via telephone. The third attempt must be in the form of a written letter sent certified, return receipt requested to the property owner's address of record in the Paulding Tax Database. If there is no response to any of the attempts, the builder/developer/construction site owner shall provide evidence to the city of the attempts at contact in addition to the arboriculture prescription for the affected tree.
- 2) If no boundary tree agreement is reached, the affected tree shall not be removed but shall be protected during development based on this chapter and in accordance with the arboriculture prescription.
- 3) A boundary tree bond or escrow account may be required based on the arboricultural prescription depending on the impact to a boundary tree covered under a boundary tree agreement.
- 4) A boundary tree bond or escrow account shall be required where a boundary tree agreement cannot be reached.
- 5) A boundary tree bond or escrow shall be one-hundred and twenty-five (125%) percent of the cost of removal and replacement of the tree(s) affected and will be held for three years by the city. The property owner of the affected tree(s) may apply to the city for the escrow funds to remove and replace the tree(s) during the three-year escrow period. If the boundary tree(s) is/are deemed healthy at the end of the three-year period by an Arborist, the developer may apply to the City for a refund of the original amount of escrow.
- 6) The site/landscape plans cannot be approved without signed boundary tree agreement(s) or proof of attempts to contact the boundary tree owner in an attempt to reach a boundary tree agreement in addition to an arboriculture prescription where needed.

#### 7) SEASONAL PLANTING.

Final plat approval or a certificate of occupancy may be issued prior to the establishment of trees planned to meet the tree canopy cover requirements, if the Community Development Director or their designee determines that the season is inappropriate for planting. In such cases the trees shall be planted by the last day of February following the date of issuance of the certificate of occupancy or final plat approval. If they have not been planted by the last day of February following the issuance of the certificate of occupancy or final plat approval, the permit holder shall be considered to be in violation of the provisions of this article.

#### 8) TREE BANK

The intent of the requirements of this Section is to ensure that a minimum number of trees are replaced and/ or preserved on newly developed or redeveloped sites. The Tree Bank is an alternative option and may be used only in the event the site tree density or recompense tree requirement cannot be met on-site due to hardship. Hardship must be documented by the developer and presented to the Director before the Tree Bank may be used. The Tree Bank provides two options, which are described in full below.

##### a. Option One, Planting Trees Off-site.

- i. Install an equal amount of required Tree Density Units in the form of an approved number of trees on an alternate site. In this case the following criteria shall be observed:
- ii. The technical Advisory Committee has identified alternate "Option One" sites. The Community Development Department has contacted the owners of these sites and these

- owners have expressed an interest in receiving trees from the Tree Bank. Persons wishing to use Option One should consult with the Zoning Administrator to see if their required tree density units can be located on one of these alternate sites. The developer may present the Community Development Director with alternate sites. Planting on individual residential lots is prohibited.
- iii. The developer shall submit a Tree Preservation and/or Tree Replacement Plan showing a location for the planted trees on the proposed site. The developer shall also provide calculations on the plan for tree density or recompense trees from the developed site. The site plan shall state the size, genus, species, and quantity of trees to be planted. Each tree must be two (2) caliper inches at a minimum. For trees in which double recompense is required each tree must be three (3) caliper inches at a minimum. Recompense calculations must be shown on plan.
  - iv. If the proposed site is not one of the alternate sites, discussed above, an authorization from the title holder of the site indicating that the owner agrees to the planting of trees by the developer upon the site shall also be submitted along with the Tree Preservation and/or Tree Replacement Plan.
  - v. Trees are to be maintained and guaranteed for one full year after planting by the developer. Any trees that die during the one-year time period must be replaced by the developer. Standards for transplanting shall be in keeping with those established by the International Society of Arboriculture, as included in the "Tree and Shrub Transplanting Manual," latest edition.
- b. Option Two, Monetary Compensation for Trees.
- i. A developer may choose to provide the City with monetary compensation for trees. If this alternative for the development is chosen, then the following criteria shall be observed:
  - ii. Provide tree density calculations on the Tree Preservation and/or Tree Replacement Plan. Show the total amount of Tree Density Units that cannot be met on-site. Multiply the Tree Density Units that cannot be met on-site by the Monetary Compensation Value. The product of those two numbers shall be provided on the Tree Preservation and/or Tree Replacement Plan. Contact City approved certified arborist or landscape architect for the current Monetary Compensation Value.
  - iii. Provide a certified check made payable to the City of Dallas in the amount of the product as listed in item ii. above and as provided on the Tree Preservation and/or Tree Replacement Plan. Submit the certified check to a Community Development Director or designee along with a copy of the approved Tree Preservation and/or Tree Replacement Plan.
  - iv. The monies collected for the Tree Bank Option Two may be used by the City for the planting of trees at parks, greenways, fire stations, libraries, and other similar community facilities. Alternate planting locations may be approved by the Director.
- c. Standards for Administering these Alternative Compliance Methods.
- i. The Director must review and approve all requests for alternative compliance. In no instance shall the alternative compliance options be used to comply with any other ordinance requirement than the tree density or specimen tree requirement. The site development permit shall be issued after the Director has approved the request for either compliance option and received the necessary documentation and funds.
- d. Exclusions.
- i. Trees used to meet requirements for parking lots, landscape strips, street frontage buffers, or buffer replanting must be planted on site and are excluded from the Tree Bank procedures. Trees that are required to meet minimum Tree Density Units and/or recompense

requirements can be contributed toward the Tree Bank in accordance with Option One or Option Two above.

### **Sec. 7.07 – REDEVELOPMENT SITES**

---

- 1) For redeveloped sites the Department of Planning and Development strongly recommends the developer, authorized registered professionals, design professionals and staff schedule a pre-submittal meeting with the department to discuss the potential of the site and any issues that may be present on the site. For the purposes of this chapter, a redeveloped site shall be considered any site that is not considered “developed” as defined within this ordinance.
- 2) Redeveloped sites shall comply with the buffer and specimen tree requirements as set forth in this ordinance and provide compliance with parking lot, landscape strip and Tree Density Unit requirements.
- 3) Where the scope of a project results in disturbance, removal, and replacement of twenty-five percent ( $\leq 25\%$ ) percent or greater of the site area, a Tree Preservation and/or Tree Replacement Plan is required. The plan shall include the existing and proposed landscape conditions that verify compliance with this ordinance.
  - a) At a minimum the plan must show the following existing and proposed elements with intent to comply:
    - i) Buffers.
    - ii) Landscape strips.
    - iii) Parking lot trees.
    - iv) Tree Density Units.
    - v) Tree Save Areas.
  - b) Director shall review the proposed Tree Preservation and/or Tree Replacement Plan.
- 4) Disturbance on a redevelopment site shall include a building replacement where the footprint of the building counts toward the site disturbance.

### **Sec. 7.08 – TREE CONSERVATION, BUFFERS, AND LANDSCAPING COMPLIANCE**

---

- 1) Tree Removal.
  - a) An application for a tree removal permit when land disturbing activity is involved shall comply with the following requirements.
    - i) Site inspections
      - 1) Authority.
        - a) The Community Development Director or their designee has the authority to perform site inspections and enforce the provisions of this chapter.
      - 2) Visits to site for discussions regarding regulations.
        - a) Prior to the issuance of a tree removal permit or right-of-way encroachment permit, a visit shall be made to the proposed site by the Community Development Director or their designee and the applicant for the purpose of discussing the provisions of this chapter.
        - b) After a permit is issued and tree protection measures have been installed, and prior to any land disturbance, another site inspection shall be made by the Community Development Director or their designee.
        - c) Another site inspection shall occur prior to the issuance of final plat approval or a certificate of occupancy. All provisions of this chapter shall be met before final plat approval or a certificate of occupancy can be issued.

- d) Other site inspections may take place without notice at any time prior to or after the issuance of a certificate of occupancy or final plat approval to ensure continuing compliance with the provisions of this chapter.
- 3) Access by authorized representatives.
  - a) No person, corporation or association shall refuse entry or access to any authorized representative or agent of the Community Development Director or their designee who requests entry for the purposes of inspection and who presents appropriate credentials, nor shall any person obstruct, hamper, or interfere with any such representative while in the process of carrying out their official duties.
- 2) Tree maintenance
  - a) The owner shall be responsible for maintaining the health of all conserved and new trees. The owner shall replace any new tree that dies within three years, or prior to issuance of the final certificate of occupancy for the project, whichever occurs last.
- 3) Penalties
  - a) Failure to obtain permit
    - i) If any person commences any land disturbing activity, tree destruction, tree cutting, tree removal or building activity requiring a tree removal permit without first obtaining said permit, the person shall be deemed to be in violation of the provisions of this chapter.
  - b) Violations
    - i) The owner of any property wherein a violation exists, and any builder, contractor, or agent who may have assisted in the commission of any such violation, may be chargeable with separate offenses for each such violation. Any person violating any of the provisions of this chapter other than as hereinabove provided shall, upon conviction, be punished as prescribed in subsection (e) of this section. Each day during which such violation occurs or continues shall constitute and be punishable as a separate offense.
  - c) Stop work orders
    - i) A stop work order may be issued by the Community Development Director or their designee for violation of any provision of this chapter. All stop work orders shall be effective immediately upon issuance and shall remain in effect until the necessary corrective action or mitigation has occurred and permission has been granted by the city to resume work. No certificate of occupancy or final plat approval shall be issued while a stop work order is in effect or until an assessed fine has been paid and permission has been granted by the city in writing for a certificate of occupancy or final plat approval.
  - d) Responsibility
    - i) The Community Development Director, or their designee is responsible for determining whether a violation has occurred. Violations may include, but are not limited to: failure to obtain a tree removal permit, deviation from the approved plan; failure to properly install tree protection structures; failure to maintain tree protection structures in effective condition; evidence of harmful activities occurring within the tree protection zone; improper planting; failure to conserve or establish the required tree canopy cover; unauthorized delay in tree planting; damage to a conserved or established tree's crown, trunk, roots, or critical root zone; and damage to a city tree's crown, trunk, roots, or critical root zone.
  - e) Monetary penalties
    - i) Any person who violates any provision of this chapter, any permit condition, or who negligently or intentionally fails or refuses to comply with any order, notice of code violation or formal charge of violation which the Community Development Director or their designee issues as provided in this chapter shall be liable for a penalty of up to one-thousand

(\$1,000.00) dollars per day for each violation of the provisions of this chapter. Each day that such failure or refusal continues shall constitute a separate violation.

Figure 7.3: Recommended Tree Type and Placement

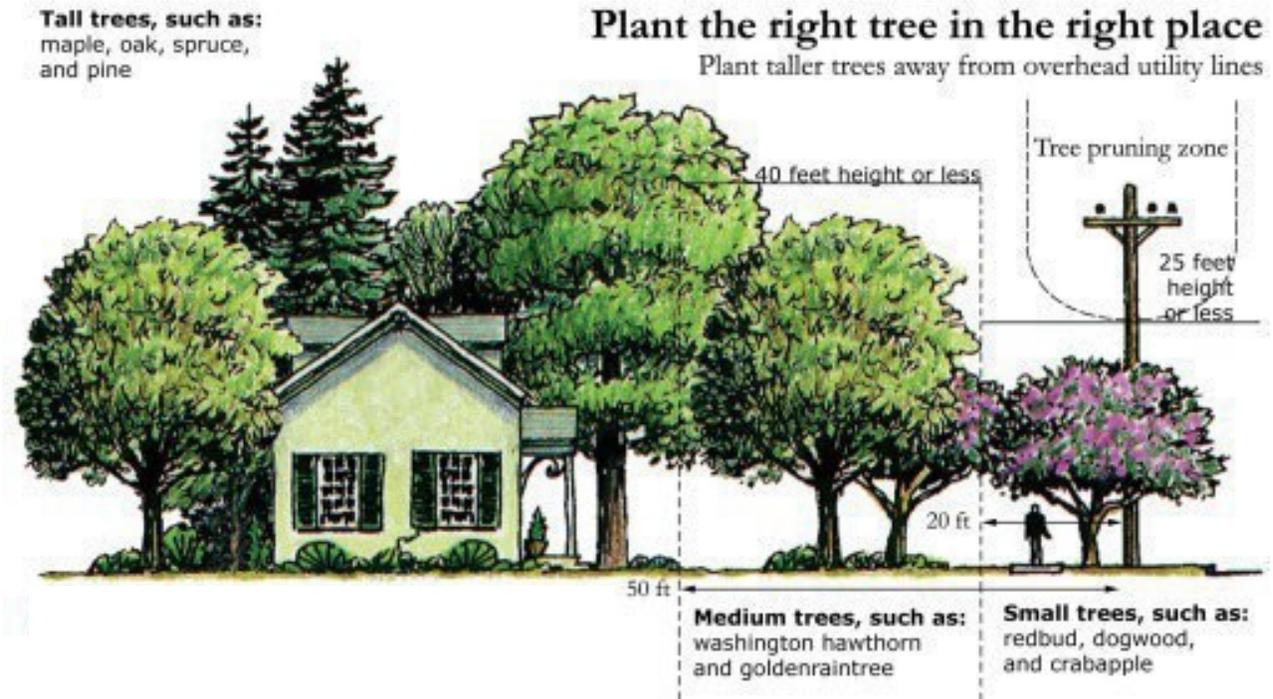

Table 7.13: Trees for Planting on Streets, Highways, and Parking Lots (generally with high canopies, shade producing, hardy)				
Botanic Name	Common Name	Type	Mature Height	Tree Category
Acer campestre	Hedge Maple	D	30'-40'	Ornamental
Acer Freemanii	Freeman Maple	D	50'-60'	Shade
Acer rubrum	Red Maple	D	40'-60'	Shade
Acer saccharum	Sugar Maple	D	50'-70'	Shade
Carpinus betulas 'Fastigiata'	Upright European Hornbeam	D	30'-40'	Shade
Carpinus caroliniana	American Hornbeam	D	25'-30'	Ornamental
Crataegus phaenopyrum	Washington Hawthorn	D	25'-30'	Ornamental
Ginkgo biloba (male only)	Ginkgo	D	40'-60'	Ornamental
Gleditsia triacanthos inermis	Thornless Honeylocust	D	30'-60'	Shade
Gleditsia triacanthos 'Imperial'	Imperial Honeylocust	D	30'-60'	Shade
Koelreuteria paniculata	Golden Rain Tree	D	30'-40'	Shade
Liquidamber styraciflua	American Sweet Gum	D	40'-60'	Ornamental
Liriodendron tulipifera	Tulip Tree	D	70'-80'	Shade
Platanus x acerifolia 'Bloodgood'	Bloodgood London Planetree	D	70-85'	Shade
Pyrus calleryana 'Aristocrat'	Aristocrat Pear	D	35'-45'	Shade
Quercus alba	White Oak D 60'-80' Shade	D	60'-80'	Shade
Quercus bicolor	Swamp White Oak	D	40'-50'	Shade
Quercus coccinea	Scarlet Oak	D	60'-80'	Shade
Quercus palustris	Pin Oak	D	50'-80'	Shade
Quercus phellos	Willow Oak	D	50'-70'	Shade
Quercus robur	English Oak	D	50'-70'	Shade
Quercus rubra	Red Oak	D	40'-60'	Shade
Sorbus alnifolia	Korean Mountain Ash	D	20'-30'	Ornamental
Sorbus 'Aria'	White Beam Mountain Ash	D	25'-40'	Ornamental
Taxodium distichum	Bald Cypress	D	50'-100'	Shade
Tillia americana Basswood	Basswood Linden	D	40'-60'	Shade
Tillia cordata 'Green Spine'	Little-Leaf Linden	D	40'-50'	Shade
Tillia tomentosa	Silver Linden	D	40'-50'	Shade
Zelkova serrata 'Village Green'	Village Green Zelkova	D	40'-60'	Shade

D = Deciduous E = Evergreen

Note: Several varieties of each species may be available and may substituted upon approval by the Director.

Table 7.14: Trees for Planting on Streets and Highways that Minimize Conflict with Overhead Utilities				
Botanic Name	Common Name	Type	Mature Height	Tree Category
Acer campestre	Hedge Maple	D	30'-40'	Ornamental
Carpinus caroliniana	American Hornbeam	D	25'-30'	Ornamental
Cercis canadensis	Eastern Redbud	D	20'-25'	Ornamental
Crataegus crus-galli	Cockspur Hawthorn	D	15'-25'	Ornamental
Crataegus phaenopyrum	Washington Hawthorn	D	20'-25'	Ornamental
Malus hybrids	Flowering Crabapple	D	15'-30'	Ornamental
Prunus 'Newport'	Newport Plum	D	15'-20'	Ornamental
Prunus maackii	Amur Chokecherry	D	25'-30'	Ornamental
Prunus virginiana	Chokecherry	D	20'-25'	Ornamental
Sorbus alnifolia	Korean Mountain Ash	D	20'-30'	Ornamental
Sorbus "Aria"	White Beam Mountain Ash	D	25'-40'	Ornamental

D = Deciduous E = Evergreen

Table 7.15: Ornamental Trees for Use in Site Interior or Buffer				
Botanic Name	Common Name	Type	Mature Height	Tree Category
Acer ginalla	Amur Maple	D	15'-20'	Ornamental
Acer griseum	Paperbark Maple	D	20'-30'	Ornamental
Acer palmatum	Japanese Maple	D	15'-20'	Ornamental
Amelanchier canadensis	Juneberry	D	30'-35'	Ornamental
Amelanchier grandiflora	Apple Serviceberry	D	25'-30'	Ornamental
Amelanchier laevis	Allegheny Serviceberry	D	25'-30'	Ornamental
Betula nigra	River Birch	D	40'-60'	Ornamental
Betula papyrifera	Paper Birch	D	40'-60'	Ornamental
Cercidyphyllum japonicum	Katsura Tree	D	25'-40'	Ornamental
Cercis Canadensis	Eastern Redbud	D	20'-30'	Ornamental
Cornus kousa	Japanese Dogwood	D	20'-25'	Ornamental
Cotinus coggyria	Smoke Tree	D	15'-20'	Ornamental
Magnolia loebneri	Magnolia	D	12'-15'	Ornamental
Magnolia soulangiana	Saucer Magnolia	D	15'-20'	Ornamental
Magnolia stellata	Star Magnolia	D	10'-15'	Ornamental
Prunus sargentii 'Columnaris'	Columnar Sargent Cherry	D	25'-30'	Ornamental
Prunus serrulata	Oriental Cherry	D	15'-25'	Ornamental
Prunus virginiana	Canada Red Select Cherry	D	20'-25'	Ornamental
Salix matsudana 'Tortuosa'	Corkscrew Willow	D	25'-30'	Ornamental

D = Deciduous E = Evergreen

Table 7.16: Evergreen Trees for Use in Site Interior or Buffer				
Botanic Name	Common Name	Type	Mature Height	Tree Category
Abies Concolor	White Fir	E	30'-50'	Evergreen
Picea abies	Norway Spruce	E	50'-60'	Evergreen
Picea glauca densata	Black Hills Spruce	E	50'-60'	Evergreen
Picea omorika	Serbian Spruce	E	50'-60'	Evergreen
Picea pungens	Colorado Spruce	E	60'-75'	Evergreen
Picea pungens 'Glauca'	Colorada Blue Spruce	E	60'-75'	Evergreen
Pinus nigra	Austrian Pine	E	30'-60'	Evergreen
Pinus ponderosa	Ponderosa Pine	E	40'-50'	Evergreen
Pinus strobus	Eastern White Pine	E	50'-100'	Evergreen
Tsuga canadensis	Canada Hemlock	E	60'-75'	Evergreen
D = Deciduous E = Evergreen				

Table 7.17: Vines for Walls and Fences		
Botanic Name	Common Name	Type
Aristolochia durior	Dutchmans's Pipe	D
Campsis radicans	Trumpetvine	D
Celastrus scandens	American Bittersweet	D
Clematis jackmanii	Clematis Hybrids	D
Clematis laguninos	Clematis Hybrids	D
Lonicera brownii	Dropmore Scarlet Honeysuckle	D
Lonicera hechrottie	Everblooming Honeysuckle	D
Parthenocissus quinquefolia	Virginia Creeper	D
Parthenocissus triscuspidata	Boston Ivy	D
D = Deciduous E = Evergreen		

Table 7.18: Small Shrubs Approved for Screens, Hedges, and Specimen Planting			
Botanic Name	Common Name	Type	Mature Height
Aronia melanocarpa	Black Chokeberry	D	4'-6'
Berberis thunbergii	Japanese Barberry	D	3'-5'
Buxus microphylla 'Koreana'	Korean Boxwood	E	2'-3'
Chaenomeles species	Flowering Quince	D	2'-6'
Cotoneaster divaricata	Spreading Cotoneaster	D	5'-6'
Euonymus fortunei	Euonymous	E	4'-6'
Hydrangea macrophylla	Nikko blue Hydrangea	D	3'-4'
Ilex crenata	Japanese Holly	E	3'-5'
Mahonia aquifolium	Oregon Grape	E	3'-6'
Physocarpus opulifolius intermedius	Dwarf Ninebark	D	4'-5'
Prunus glandulosa	Dwarf Flowering Almond	D	4'-6'
Rhus aromatica	Fragment Sumac	D	4'-6'
Symphoricarpos alba	White Snowberry	D	5'-6'
Weigela florida	Flowering Weigela	D	4'-5'
Weigela vaniceki	Cardinal Shrub	D	4'-5'
D = Deciduous E = Evergreen			

<b>Botanic Name</b>	<b>Common Name</b>	<b>Type</b>	<b>Mature Height</b>
<i>Caragana arborescens</i>	Siberian Peashrub	D	12'-15'
<i>Cornus alba</i> , 'Elegantissima'	Variiegated Dogwood	D	6'-10'
<i>Cornus alternifolia</i>	Pagoda Dogwood	D	15'-20'
<i>Cornus sericea baileyi</i>	Redtwig Dogwood	D	8'-10'
<i>Cotinus coggygria</i>	Smoke Tree	D	8'-10'
<i>Cotoneaster acutifolius</i>	Peking Cotoneaster	D	4'-8'
<i>Euonymus alatus</i> 'compactus'	Burning Bush	D	7'-10'
<i>Forsythia intermedia</i> Hybrids	Hybrid Forsythia	D	7'-10'
<i>Forsythia suspensa</i>	Weeping Forsythia	D	8'-10'
<i>Hamamelis virginiana</i>	Common Witch Hazel	D	10'-15'
<i>Hibiscus syriacus</i>	Rose of Sharon	D	4'-12'
<i>Hydrangea arborescens</i> 'Annabelle'	Annabelle Hydrangea	D	4'-15'
<i>Hydrangea paniculata</i> 'Grandiflora'	Peegee Hydrangea	D	6'-10'
<i>Ilex meserveae</i>	Blue Holly	E	6'-8'
<i>Ilex opaca</i>	American Holly	E	8'-15'
<i>Juniperus chinensis</i>	Chinese Juniper	E	6'-15'
<i>Juniperus scopulorum</i>	Rocky Mountain Juniper	E	6'-15'
<i>Ligustrum amurense</i>	Amur Privet	D	4'-8'
<i>Ligustrum</i> 'Vicaryi'	Golden Vicary Privet	D	4'-12'
<i>Myrica pennsylvanica</i>	Northern Bayberry	D	5'-10'
<i>Philadelphus coronarius</i>	Sweet Mockorange	D	8'-10'
<i>Philadelphus virginialis</i>	Minnesota Snowflake	D	6'-8'
<i>Picea glauca</i> 'Conica'	Dwarf Alberta Spruce	E	6'-10'
<i>Prunus cistena</i>	Cistena Plum	D	6'-8'
<i>Prunus triloba</i>	Flowering Almond	D	8'-10'
<i>Rhamnus frangula</i>	Alder Buckthorn	D	12'-15'
<i>Rhus glabra</i>	Smooth Sumac	D	8'-10'
<i>Rhus typhina</i>	Staghorn Sumac	D	8'-12'
<i>Salix caprea</i>	French Pussy Willow	D	15'-20'
<i>Sambucus canadensis</i>	American Elderberry	D	6'-8'
<i>Shepherdia argentea</i>	Silver Buffaloberry	D	5'-8'
<i>Sorbaria sorbifolia</i>	Flase Spiraea	D	6'-8'
<i>Syringa chinensis</i>	Chinese Lilac	D	6'-8'
<i>Syringa hyacinthiflora</i> Hybrids	Hybrid Canadian Lilac	D	8'-12'
<i>Syringa vulgaris</i>	Common Lilac	D	8'-12'
<i>Syringa vulgaris</i> Hybrids	Hybrids Hybrid French Lilac	D	8'-12'
<i>Taxus cuspidata</i> 'Capitata'	Upright Japanese Yew	E	10'-25'
<i>Taxus</i> 'Hicksi'	Hick's Yew	E	10'-12'
<i>Viburnum dentatum</i>	Arrowwood Viburnum	D	0'-15'
<i>Viburnum lantana</i>	Wayfaring Tree	D	8'-15'
<i>Viburnum lantago</i>	Nannyberry	D	8'-15'
<i>Viburnum opulus</i>	European Cranberry Bush	D	10'-12'
<i>Viburnum placatum tomentosum</i>	Doublefile Viburnum	D	8'-10'
<i>Viburnum prunifolium</i>	Black Haw Viburnum	D	10'-12'
<i>Viburnum rhytidophyllum</i>	Leatherleaf Viburnum	D	6'-15'
<i>Viburnum trilobum</i>	American Cranberry Bush	D	8'-12'

D = Deciduous E = Evergreen

<b>Botanic Name</b>	<b>Common Name</b>	<b>Type</b>	<b>Mature Height</b>
<i>Berberis mentorensis</i>	Mentor Barberry	E	3'-4'
<i>Berberis thunbergii</i> Hybrids	Japanese Barberry	D	2'-4'
<i>Berberis verruculosa</i>	Warty Barberry	E	2'-3'
<i>Buxus sempervirens</i>	Boxwood	E	2'-3'
<i>Cotoneaster apiculata</i>	Cranberry Cotoneaster	D	2'-3'
<i>Cotoneaster horizontalis</i>	Rockspray Cotoneaster	D	1'-3'
<i>Daphne burkwoodii</i>	Burkwood Daphne	D	3'-4'
<i>Duetzia gracilis</i>	Slender Duetzia	D	2'-3'
<i>Euonymus fortunei</i> 'Sarcoxie'	Sarcoxie Euonymus	E	3'-4'
<i>Forsythia viridissima</i> 'Bronxensis'	Dwarf Forsythia	D	1'-2'
<i>Hypericon patulum</i>	St. John's Wort	D	2'-3'
<i>Juniperus</i> (spreading varieties)	Juniper	E	1'-3'
<i>Mahonia aquifolium</i> 'Compacta'	Dwarf Oregon Grape	E	2'
<i>Microbiota decussata</i>	Siberian Cypress	E	1'
<i>Philadelphus virginialis</i>	Miniature Snowflake	D	2'-3'
<i>Picea abies</i> 'Nidiformis'	Birdnest Spruce	E	2'
<i>Picea abies</i> 'Pumila'	Dwarf Norway Spruce	E	2'-3'
<i>Picea pungens</i> 'Globosa'	Blue Globe Spruce	E	3'-4'
<i>Pinus mugo</i>	Mugho Pine	D	3'-4'
<i>Potentilla fruticosa</i> Hybrids	Bush Cinqufoil	D	2'-3'
<i>Rhus aromatica</i> 'Low Grow'	Low Grow Fragrant Sumac	D	1'-2'
<i>Ribes alpinum</i>	Alpine Currant	D	3'-5'
<i>Spirea bumalda</i>	Spirea	D	2'-3'
<i>Spirea japonica</i>	Japanese Spirea	D	2'-3'
<i>Spirea nipponica</i>	Nippon Spirea	D	2'-3'
<i>Symphoricarpos orbiculatus</i>	Coral Berry	D	3'-4'
<i>Syringa patula</i> 'Miss Kim'	Dwarf Korean Lilac	D	3'-5'
<i>Taxus cupidata</i> 'Nana'	Dwarf Japanese Yew	E	2'-3'
<i>Taxus media</i>	Spreading Yew	E	2'-4'
<i>Viburnum opulus</i> 'Nana'	European Cranberry Bush	D	1'-2'
D = Deciduous E = Evergreen			

Table 7.21: Non-Qualifying Trees		
Common Name	Botanical Name	Negative Feature(s)
Boxelder	<i>Acer negundo</i>	Aggressive, Shallow roots, Weak wood
Norway Maple	<i>Acer platanoides</i>	Invasive
Silver Maple	<i>Acer saccharinum</i>	Aggressive, Shallow roots, Weak wood
Tree of Heaven	<i>Ailanthus altissima</i>	Seeds, Suckers, Weak wood, Invasive
Mimosa	<i>Albizia julibrissin</i>	Invasive
European White Birch	<i>Betula pendula</i>	Insect prone, Invasive
Hackberry	<i>Celtis occidentalis</i>	Disease prone
Camphor Tree	<i>Cinnamomum camphora</i>	Invasive
Russian Olive	<i>Elaeagnus angustifolia</i>	Poor form, Disease prone, Invasive
Ash	<i>Fraxinus</i>	Disease prone
Ginkgo (Female)	<i>Ginkgo biloba</i>	Female Fruits
White Lead Tree	<i>Leucaena leucocephala</i>	Invasive
Chinaberry Tree	<i>Melia azedarach</i>	Invasive
Mulberry	<i>Morus species</i>	Fruits, Shallow roots, Invasive
Princess Tree	<i>Paulownia tomentosa</i>	Invasive
Senegal Date Palm	<i>Phoenix reclinata</i>	Invasive
White Poplar	<i>Populus alba</i>	Suckers, Shallow roots, Weak wood, Invasive
Cottonwood	<i>Populus deltoides</i>	Weak wood, Shallow roots, Seeds
Lombardy Poplar	<i>Populus nigra 'Italica'</i>	Insects, Disease, Short-lived
(Wild) Black Cherry	<i>Prunus serotina</i>	Disease prone
Bradford Pear	<i>Pyrus calleryana 'Bradford'</i>	Weak branching, Low branches
Brazilian Pepper Tree	<i>Schinus terebinthifolius</i>	Invasive
Tallow Tree	<i>Triadica sebifera</i>	Invasive
American Elm*	<i>Ulmus americana*</i>	Insects, Disease
Siberian Elm	<i>Ulmus pumila</i>	Weak wood, Seeds

\* Note that suitable disease resistant cultivars and hybrids exist as substitutes for this species

Sec. 7.09 – FENCES, WALLS, AND HEDGES

---

- 1) INTENT. The purpose of these standards is to provide minimum requirements in order to provide adequate light, air circulation, and privacy; and to protect the public welfare by preventing visual obstructions along public ways.
- 2) EXEMPTIONS.
  - a) Agriculture. If engaged in agricultural operations or activities, properties located in any district where agriculture is permitted shall be exempt from the provisions of this section.
  - b) Athletic Facilities. Fences for ball diamonds, tennis courts, driving ranges and other athletic facilities shall be exempt from the provisions of this section.
- 3) GENERAL REQUIREMENTS. Fences, walls, and hedges shall be permitted in all zoning districts subject to conformance with the following requirements:
  - a) Drainage. No fence, wall, or hedge shall disrupt the flow of water in any drainage easement, or otherwise result in impediments for stormwater runoff. Any fence, wall, or hedge located in an easement may be removed by the easement holder when accessing the easement.
  - b) Setbacks. All fences, walls, and hedges may be permitted up to a property line except as noted in this Ordinance. No fence, wall, or hedge shall be placed in any right-of-way or violate the sight distance requirements found in *Section 7.04 – Sight Visibility*. Fences, walls, and hedges within the easement of a drain, pond, and/or lake shall require the approval of the City Engineer.
  - c) Buffer Yards. No fence, wall, or hedge may be placed in any required buffer yard that does not specifically provide for the inclusion of a fence.
  - d) Materials.
    - i) Fences shall not contain an electric charge except when located on properties with an agricultural use, and other uses as approved by Special Exception by the City Council.
    - ii) When enfronting a public right-of-way or public easement, the finished face of any fence shall be so erected as to face the public way.
    - iii) Fences and walls shall be constructed of wood, decorative metal, textured masonry or synthetic materials styled to simulate natural materials. Barbed wire and razor wire are permitted only on properties with an agricultural use, or in the Industrial, Low-Density (I-1) and the Industrial, Medium-Density (I-2) districts.
    - iv) Chain-link fences shall be permitted in all districts. Chain-link fences in residential districts shall be located only in the rear yard area, shall be vinyl-coated, except as prohibited by a Home Owners Association regulation or restrictions.
  - e) Height.
    - i) Exception. The height of fences screening telecommunications facilities is regulated by *Section 7.11 – Wireless Communication Facilities*.
    - ii) Height Measurement. The height of a fence, wall or hedge shall be determined by measuring from the adjacent grade to the highest point of the fence, wall or hedge, excluding posts. Fence posts may exceed the maximum height of the fence by up to one (1) foot.
    - iii) Unless otherwise regulated by this chapter, fences and walls shall not exceed eight (8) feet in height in nonresidential districts and six (6) feet in height in residential districts in the rear and side yards. Fences, walls and hedges shall not exceed four (4) feet in height in the front yard.

Permitted Use	Front Yard	Side Yard	Rear Yard
<b>Single-Family Use</b>	3'0" solid fence 4'0" combined or predominantly open fence	6'0"	6'0"
<b>Multifamily Use</b>	3'0" solid fence 4'0" combined or predominantly open fence	6'0"	6'0"
<b>Commercial &amp; Office Use</b>	3'0" solid fence 4'0" combined or predominantly open fence	6'0"	6'0"
<b>Industrial Use</b>	8'0"	8'0"	8'0"
<b>Parking Lots, Vacant Lots, Churches, Schools, Swimming Pools, Stormwater Management Facilities, and Parks</b>	3'0" solid fence 4'0" combined or predominantly open fence	6'0"	6'0"

- f) Opacity. A fence, wall or hedge in the front yard shall permit direct vision from one side to the other through at least fifty percent (50%) of the structure.
- g) Notwithstanding the provisions of subsection (3)(e), above, a fence may be erected or altered up to a height of eight (8) feet where:
  - i) The ground floor elevation within twenty (20) feet or less of the principal dwelling on either one of the two (2) adjoining lots is at least four (4) feet higher than the elevation at the adjoining lot line; or
  - ii) The fence is erected along a side or rear lot line which adjoins a collector street or arterial street (in which case landscape planting shall be provided in accordance with *Subsection 7.05(7)* of this chapter) as part of a multiple lot residential subdivision; or
  - iii) The fence is a sound barrier or fence required by GDOT or a security fence required by the Department of Homeland Security for a public or institutional use; or
  - iv) The additional fence height is permitted by the City Council pursuant to a rezoning or specific use authorization; or
  - v) The fence is located on a side or rear lot line which abuts a C-2 or I-2 use or more intensive use that does not require a buffer yard.
  - vi) Notwithstanding the provisions of *Subsection (3)(e)*, above, a fence may be erected or altered up to the height of the adjacent building where the fence is located entirely on the interior of a lot behind all required building setback lines, attached to the main structure, and used for security purposes or for part of the intended use of the primary structure, such as fencing for outdoor display, for example an outdoor garden area, or lumber yard attached to a home improvement store.
  - vii) The following illustration shall be used to determine applicable front, side and rear fence standards:

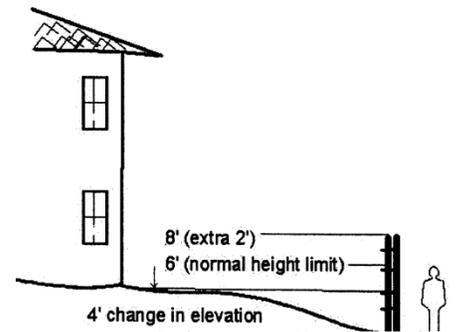
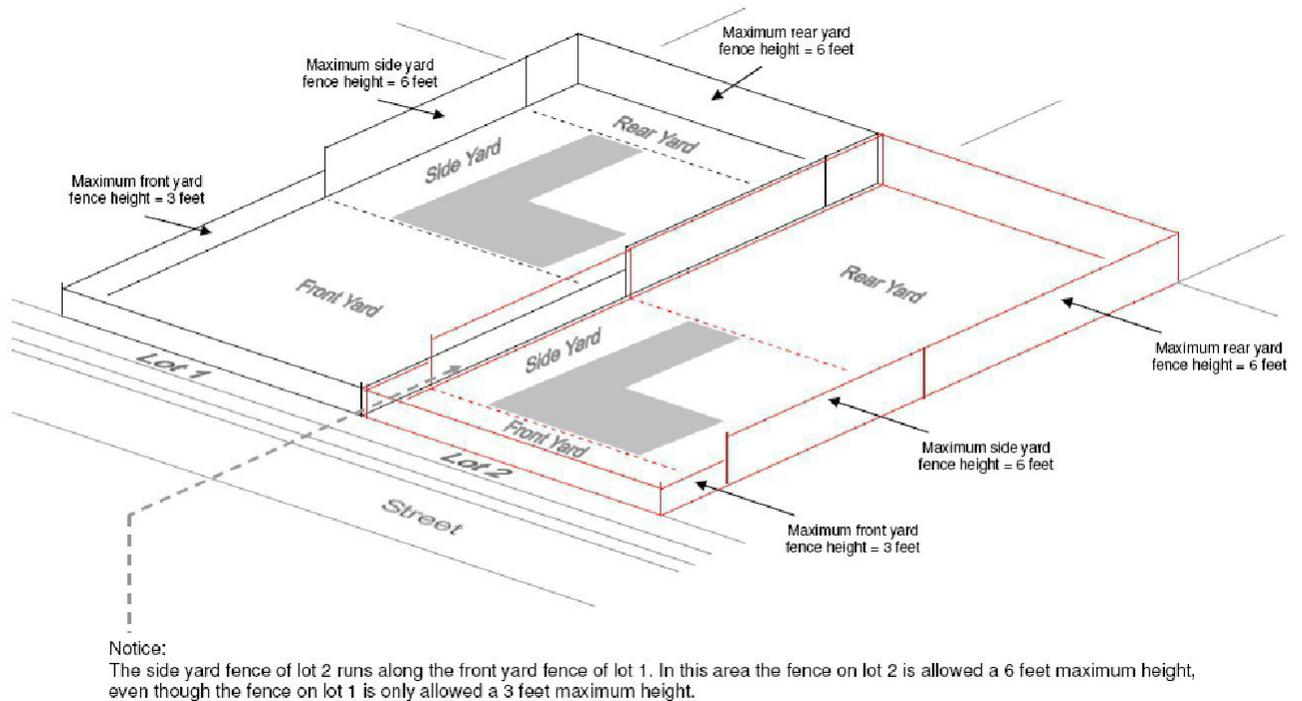

Figure 7.4: Additional height where home on adjacent lot is 4' higher (*subsection 7.09(3)(g)i*).

Figure 7.5: Fences and Yard Determinations



### Sec. 7.10 – HEIGHT STANDARDS

#### 1) GENERAL HEIGHT STANDARDS APPLICABLE TO ALL ZONING DISTRICTS:

- a) **Height Requirements.** The maximum height permitted shall be as described below and in accordance with *Table 4.4: Residential Lot Standards* and *Table 4.5: Non-Residential Lot Standards*, subject to the exceptions listed in this section.
  - i) **Measuring Height.** In all instances, the height of a structure shall be the vertical height from the average finished grade to the highest point of the roof, parapet, or uppermost part of the building or structure.
- b) **Exceptions.** No structure may be erected or changed so as to make its height greater than specified in the applicable zoning district, except as noted below.
  - i) **General Exceptions.**
    - (1) Steeples on religious places of worship;
    - (2) Spires, belfries, and cupolas;
    - (3) Industrial-related storage tanks, mechanical equipment, and smokestacks; and
    - (4) Water towers.
  - ii) **Agricultural Structures.** All structures in a zoning district where agriculture is allowed that are used in agricultural product storage and/or processing may exceed the permitted height standards for that district and be erected to any height that is necessary for their operation.
  - iii) **Wireless Communication Facilities.** The height of wireless communication facilities shall be regulated by *Section 7.11 – Wireless Communication Facilities*.
  - iv) **Amateur Radio Towers.** Amateur radio towers may exceed the permitted height regulations by up to ten (10) feet.

- v) Noncommercial Wind Energy Conversion Systems. Wind energy conversion systems are exempt up to 120 feet in height. For propeller turbines, the height shall be measured from the rotor blade at its highest point to the top surface of the wind energy conversion system foundation. For vertical axis turbines, the height shall be measured from the highest point of the unit to the top surface of the wind energy conversion system foundation
- vi) Necessary Appurtenances. The following structural elements may exceed the permitted height standards for the zoning district in which they are located by up to ten (10) feet:
  - (1) Necessary mechanical appurtenances;
  - (2) Water tanks;
  - (3) Chimneys;
  - (4) Fire towers;
  - (5) Stair towers;
  - (6) Elevator bulkheads; and
  - (7) Wind energy conversion systems, rooftop.
- c) Air Space Requirements. Nothing in this Ordinance, including the exceptions listed above shall be interpreted as waiving any height regulations related to air transportation. All applicable Federal Aviation Administration (FAA) and State of Georgia restrictions and regulations, including *Federal Aviation Regulation Part 77* and *Objects Affecting Navigable Airspace (FAR Part 77)* shall apply to all structures.

#### **Sec. 7.11 – WIRELESS COMMUNICATION FACILITIES**

---

- 1) PURPOSE. In recognition of the quasi-public nature of cellular and/or wireless communication systems, it is the purpose of these regulations to:
  - a) Accommodate the need for cellular or wireless communication towers while regulating their location and number in the City;
  - b) Minimize adverse visual effects of communication towers and support structures through proper siting, design and screening;
  - c) Avoid potential damage to adjacent properties from communication towers and support structure failure; and
  - d) Encourage the joint use of any new and existing communication towers and support structures to reduce the number of such structures needed in the future.
- 2) USE REGULATIONS. The following use regulations shall apply to cellular or wireless communication antennas and towers.
  - a) A cellular or wireless communications antenna that is mounted to an existing communications tower (whether said tower is for cellular purposes or not), smoke stack, water tower or other tall structure, shall be permitted as of right in all zoning districts. Cellular or wireless communications antenna may also be located on the top of buildings that are no less than fifty (50) feet in height.
  - b) A cellular or wireless communications antenna that is mounted to an existing structure as indicated above shall be painted a color which matches, or is compatible with, the structure on which it is located.
  - c) A cellular or wireless communications antenna is permitted as a special exception in the I-2 zoning districts only if it is:
    - i) mounted on its own tower (as opposed to it being mounted on an existing structure); or
    - ii) more than fifteen (15) feet higher than the structure on which it is mounted.

- d) All other non-essential uses accessory to the cellular or wireless communications antenna and towers including, but not limited to business offices, maintenance depots, and materials and vehicle storage, are prohibited from the site unless otherwise permitted in the zoning district in which the cellular or wireless communications antenna and/or tower is located.
- 3) STANDARDS OF APPROVAL FOR CELLULAR OR WIRELESS COMMUNICATIONS ANTENAS AND TOWERS PERMITTED BY SPECIAL EXCEPTION. The following standards shall apply to cellular or wireless communications antennas and towers permitted as special exception uses.
- a) The cellular or wireless communications company shall be required to demonstrate as part of the special exception application process, using the latest technological evidence, that the antenna or tower must be placed at the proposed location and at the proposed height in order to satisfy its necessary function in the company’s grid system. As part of this requirement, a Radio Frequency (RF) map of sufficient scale shall be submitted to the Community Development Director demonstrating a need for the tower at the location and height proposed.
  - b) If the cellular or wireless communications company proposes to build a cellular or wireless communications tower (as opposed to mounting the antenna on an existing structure), it is required to demonstrate that it has contacted the owners of nearby tall structures within a one (1) mile radius of the site proposed, asked for permission to install the cellular or wireless communications antenna on those structures, and was denied for reasons other than economic ones. “Tall structures” shall include, but not be limited to: smoke stacks, water towers, buildings over fifty (50) feet in height, antenna support structures of other cellular or wireless communication companies, other communication towers and roadway lighting poles.

Figure 7.6: Wireless Telecom Layout

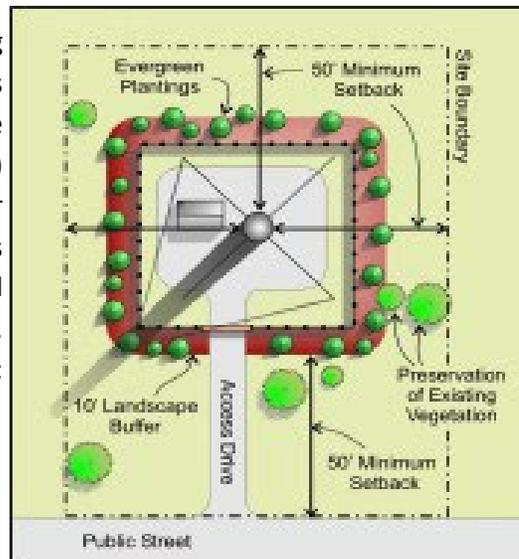

- c) The City Council may deny the special exception if the applicant has not made a good faith effort to mount the antenna on existing structures.
  - i) The location and dimensions of all curb cuts, driving lanes, off-street parking and loading areas including the number of spaces, grades, surfacing materials, drainage plans and illumination of the facility;
  - ii) The location and dimensions of all curb cuts, driving lanes, off-street parking and loading areas including the number of spaces, grades, surfacing materials, drainage plans and illumination of the facility;
  - iii) All existing and proposed sidewalks and open areas on the site;
  - iv) The location of all proposed fences, screening and walls;
  - v) The location of all existing and proposed streets;
  - vi) All existing and proposed utilities including types and grades;
  - vii) All existing and proposed landscaping in accordance with *Subsection 7.11(4)(e)*;
  - viii) The schedule of any phasing of the project;

- ix) A written statement by the cellular or wireless communications company as to the visual and aesthetic impacts of the proposed cellular or wireless communications tower on all adjacent residential zoning districts; and
  - x) Any other information as may be required by the City Council to determine the conformance with this Zoning Ordinance.
- 4) STANDARDS OF APPROVAL OF ALL CELLULAR OR WIRELESS COMMUNICATIONS ANTENNAS AND TOWERS
- a) Antenna/Tower Height. The applicant shall demonstrate that the antenna/tower is the minimum height required to function satisfactorily and provide an acceptable number of towers.
  - b) Setbacks from the Base of the Tower. If a new cellular or wireless communications tower is to be constructed, the minimum distance between the base of the tower or any guy wire anchors and the property line shall be the greater of the following:
    - i) Forty (40) percent of the tower height;
    - ii) The minimum setback in the underlying zoning district; or
    - iii) Fifty (50) feet.
  - c) Cellular or Wireless Communications Tower Safety. The applicant shall demonstrate that the proposed cellular or wireless communications tower and its antenna are safe and that the surrounding properties will not be negatively affected by tower failure, falling ice or other debris, electromagnetic fields or radio frequency interference. Furthermore, all cellular or wireless communications towers shall be fitted with anticlimbing devices as approved by the manufacturers.
  - d) Fencing. A fence shall be required around the cellular or wireless communications tower and its support structure(s), unless the antenna is mounted on an existing structure. The fence shall be a minimum of eight (8) feet in height and shall be erected to prevent access by non-authorized personnel.
  - e) Landscaping.
    - i) Landscaping shall be required to screen as much of the freestanding cellular or wireless communications tower, support structures, and surrounding fence as possible and any other ground-level features and, in general, to soften the appearance of the cellular communications site.
    - ii) The Director may permit any combination of existing vegetation, topography, walls, decorative fences or other features instead of landscaping, if they achieve the same degree of screening as the required landscaping.
  - f) Limiting the Number of Cellular or Wireless Communications Towers. In order to reduce the number of antenna support structures needed in the City in the future, the proposed cellular or wireless communications tower shall be required to accommodate other users, including other cellular communications companies, and local police, fire and ambulance departments. The applicant shall provide proof that co-location is not feasible.
  - g) Licensing. The cellular or wireless communications company must demonstrate to the City that it is licensed by the Federal Communications Commission (FCC).
  - h) Required Parking. If the cellular or wireless communications site is fully automated, adequate parking shall be required for maintenance workers. If the site is not fully automated, the number of required parking spaces shall equal the number of employees working on the largest shift. All parking specifications and requirements shall be consistent with the applicable parking

requirements as established in this Ordinance.

- i) **Appearance.** Cellular or wireless communications towers under two-hundred (200) feet in height shall be painted silver or have a galvanized finish retained in order to reduce visual impact. Cellular or wireless communications towers shall meet all Federal Aviation Administration (FAA) regulations. No cellular or wireless communications towers may be artificially lighted except when required by the FAA. Furthermore, no cellular communication tower or antenna shall contain any signage containing a commercial message.
- 5) **MAINTENANCE.** Any owner of property used as a cellular or wireless communications site shall maintain such property and all structures in good condition and free from trash, outdoor storage, weeds and other debris. Any cellular or wireless communications tower that has discontinued its service for a period of twelve (12) continuous months or more shall be removed, along with all accessory structures related thereto. Discontinued shall mean that the structure has not been properly maintained, has been abandoned, become obsolete, unused or has ceased the daily activities or operations which had occurred.

**Sec. 7.12 – OUTDOOR LIGHTING**

- 1) **INTENT.** Exterior lighting shall be subject to the following lighting standards and should be consistent and compatible with the design, color and scale of the associated development. Light levels shall most importantly be uniform to promote the health, safety, and welfare of users.
- 2) **GENERAL PROVISIONS.** All areas containing outdoor lighting, including but not limited to floodlighting, security, street, or parking lot lighting shall comply with the requirements of this section.

- a) **Light Trespass.** All areas containing outdoor lighting shall limit light spillage onto adjacent property, when measured at any point along a property line to the requirements set forth in *Table 7.23: Light Trespass*. Compliance shall be achieved by utilizing fixture shielding, directional control designed into fixtures, fixture location, height, or aim, or a combination of these or other factors.

<b>Table 7.23: Light Trespass</b>	
<b>Adjoining District</b>	<b>Light Spillage Measured in Foot-Candels (maximum light level at the property line)</b>
R-1, R-2, R-3, TH, MF-1, MF-2, CBD, CMU, PUD*	0.20
C-1, C-2, OMI, I-1, I-2, PUD*, Public RoW	0.50

\*In PUDs, Light Spillage for residential uses shall not exceed 0.20, and 0.50 for non-commercial uses.

- b) **Light Shielding.** Unless light fixtures of a particular period or architectural style are used, all new, repaired, or replaced lighting, whether public or private, shall be full cutoff or fully shielded.
- c) **Mounting Height Measurement.** For the purposes of this section, the mounting height of all light fixtures shall be defined as the vertical distance between the adjacent grade of the surface being illuminated and the top of the lighting fixture (luminaire).
- d) **Use of Timers/Dimmers.** Wherever practicable, exterior lighting shall include timers, dimmers, and/or sensors to reduce overall energy consumption and eliminate unneeded lighting.

- e) Electrical Service. The electrical service to all outdoor lighting fixtures shall be underground, unless the fixtures are mounted directly on buildings or utility poles.
  - f) Holiday Lighting. Holiday lighting shall be exempt from the provisions of this section.
  - g) Lamp Color. Lamps (the source of the actual light) shall be halogen, metal halide or other type which ensures true-color at night.
- 3) LIGHTING PLAN. Wherever a lighting plan is called for by this Ordinance, such plan shall include the following:
- a) Lighting plan showing buildings, landscaping, parking areas, and the locations of all proposed exterior lighting fixtures, with designation of full cutoff and/or fully shielded fixtures;
  - b) A description of the outdoor light fixtures which may include but is not limited to manufacturer’s catalog cuts, photometric report with candela distribution, drawings, and shielding information;
  - c) Analysis and illuminance level diagrams showing that the proposed installation conforms to the lighting level standards in this Ordinance.
- 4) LIGHTING PLAN. Wherever a lighting plan is called for by this Ordinance, such plan shall include the following:
- a) Lighting plan showing buildings, landscaping, parking areas, and the locations of all proposed exterior lighting fixtures, with designation of full cutoff and/or fully shielded fixtures;
  - b) A description of the outdoor light fixtures which may include but is not limited to manufacturer’s catalog cuts, photometric report with candela distribution, drawings, and shielding information;
  - c) Analysis and illuminance level diagrams showing that the proposed installation conforms to the lighting level standards in this Ordinance.
- 5) ILLUMINATION OF BUILDINGS AND OTHER VERTICAL STRUCTURES. When buildings or other structures are illuminated, the design for the illumination must be in accordance with the following:
- a) Lighting fixtures shall be located and/or aimed such that light is directed only onto the building surface. All fixtures used to illuminate buildings shall be fully shielded;
  - b) For statues, monuments, fountains, or other objects for which it may not be possible to reliably and consistently illuminate with downward lighting, up-lighting may be used only in the form of spotlights which confine the illumination to the object of interest; and
  - c) If up-lighting is used to illuminate flags, only spotlights shall be used; floodlights directed above the horizontal shall not be used to illuminate a flag.
- 6) Building-mounted neon lighting is allowed only when recessed, or contained in a cap or architectural reveal.

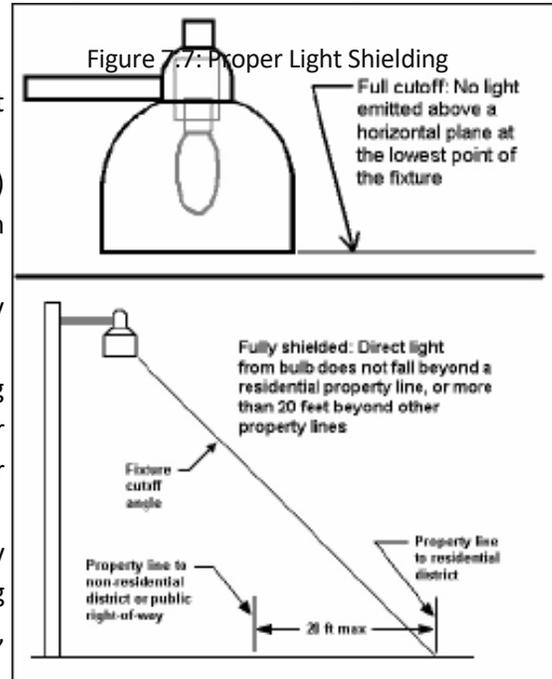
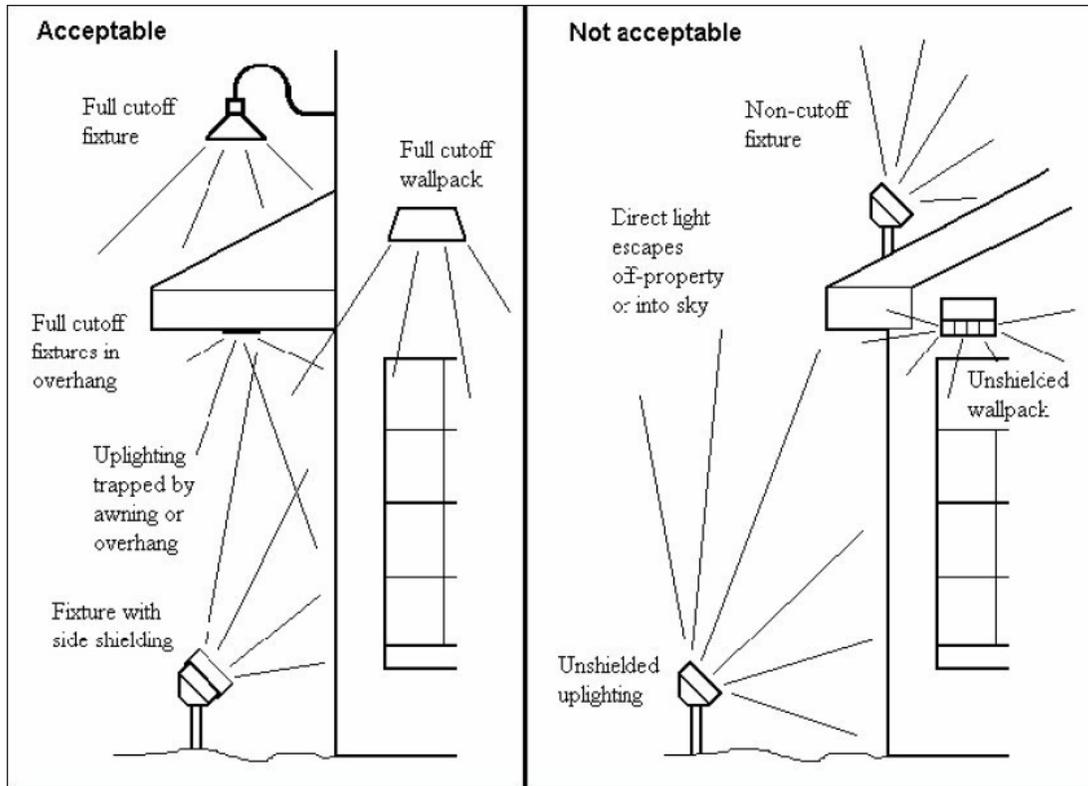

Figure 7.8: Proper Feature Lighting Examples



## 7) PARKING AREAS

- a) Luminaires / lighting fixtures serving parking areas shall be full cutoff fixtures.
- b) The maximum average-maintained illumination level for a parking lot shall be no more than 1.6 horizontal foot-candles at grade level.
- c) Light fixtures located on the perimeter of parking lots and within twenty (20) feet of a property line shall utilize *IESNA Type IV* forward throw optical distribution and/ or “house-side” shielding to minimize light spillage with respect to that property line.
- d) Lights shall not exceed twenty-five (25) feet in height from the adjacent grade to the top of the fixture.
- e) Building-mounted lighting shall not be permitted to illuminate parking areas.

## 8) LIGHTING OF EXTERIOR DISPLAY OR OPEN SALES AREAS (excluding motor vehicle dealerships)

- a) Light fixtures serving areas designated as exterior display or open sales areas shall be full cutoff and/or fully shielded fixtures.
- b) Areas designated as exterior display or open sales areas shall be illuminated so that the average maintained horizontal illumination at grade level does not exceed 4.0 foot-candles.
- c) Light fixtures located on the perimeter of display or sales areas and within twenty (20) feet of a property line shall utilize *IESNA Type IV* forward throw optical distribution and/or “house-side” shielding to minimize light spillage with respect to that property line.

## 9) LIGHTING OF MOTOR VEHICLE DEALERSHIPS

- a) Full cutoff light fixtures shall be required for car dealerships.
- b) Car dealerships can define thirty percent (30%) of their site as display area and illuminate that area up to thirty-five (35) foot-candles (maximum) while limiting light trespass and using fully shielded fixtures.

- c) The remaining seventy percent (70%) of the car dealership site shall be subject to the same lighting standards for light levels and light trespass as other commercial sites.
- 10) LIGHTING OF WALKWAYS, BIKEWAYS, PARKS AND PLAYGROUNDS. Where special lighting is to be provided for walkways, bikeways, or parks, the following requirements shall apply:
- a) The walkway, pathway, or ground area shall be illuminated to a level of no more than 0.5 average horizontal foot-candles;
  - b) The vertical illumination levels at a height of five (5) feet above grade shall be no more than 0.5 average vertical foot-candles; and
  - c) Lighting fixtures shall be designed to direct light downward, and the initial output of light sources shall not exceed one-thousand (1,000) lumens.
  - d) Light pole height shall not exceed fifteen (15) feet. Bollard lighting, not exceeding four (4) feet in height is encouraged.
- 11) LIGHTING OF CANOPIES, BAYS, AND LOADING AND UNLOADING SPACES
- a) The average maintained horizontal illumination shall not exceed twenty-five (25) foot-candles.
  - b) Areas used for parking or vehicle storage shall be illuminated in accordance with the requirements for Parking Lot Lighting.
  - c) Light fixtures mounted on or under overstory ceilings, in bays, and in loading and unloading spaces shall be recessed, full cutoff and fully shielded, unless indirect lighting is being used whereby light is directed upward and then reflected down from the ceiling of the structure. In this case, light fixtures must be shielded so that direct illumination is focused exclusively on the ceiling of the structure.
  - d) Lights shall not be mounted on the top or sides of an overstory.
  - e) Lighting for drive-through bays must be fully shielded as if located outside.
- 12) OUTDOOR ATHLETIC/PERFORMANCE FACILITIES
- a) Outdoor activity facilities may have unique lighting needs pertaining to the performing or playing area. A design plan for such a facility shall detail the lighting requirements of the performing or playing area and how unwanted glare, illumination of surrounding streets and properties, and nighttime atmospheric light pollution will be minimized.
  - b) Limits on light trespass appearing in *Subsection 7.12(2)(a)* of this section apply to such outdoor facilities. If floodlighting is used in place of full cutoff fixtures, the center beam shall be aimed below the horizontal plane at an angle not less than one-half (0.5) the angular beam spread of the fixture. Glare shall be controlled by fixture design, location, shielding, or natural/positioned obstructions on the parcel where the facilities are located. Every such lighting system design and installation shall be certified by a registered engineer as conforming to all applicable restrictions of this Ordinance.
  - c) Except for professional or amateur events covered by intrastate televised broadcast, thirty (30) foot-candle horizontal illumination of the playing field or performing area shall not be exceeded. Parking facilities, walkways, and other lighting applications associated with venues for the outdoor activities covered herein shall conform to the requirements specified in the sections of this Ordinance applicable to those lighting applications. Light levels adjacent to residential districts or uses shall not exceed 0.20 foot-candle at the property line.
  - d) Outdoor Activity Light poles shall not exceed one-hundred (100) feet in height. The use of spotlights and/or floodlights to illuminate the play/performance area shall be permitted. However, each facility shall be designed and constructed with a dual lighting system which

permits the main lighting for the event (spotlighting, floodlighting, etc.) to be turned off, with an alternate low level lighting system used for clean-up, night maintenance and other activities. Outdoor Activity lights shall shut off by 11:00 p.m. or no more than thirty (30) minutes after the activity is completed.

13) STREET LIGHTING.

- a) Unless street light fixtures of a particular period or architectural style are used, all new, repaired or replaced street lighting, whether public or private, shall utilize full cutoff and/or fully shielded fixtures.
- b) If street light fixtures of a particular period or architectural style are used then all such fixtures shall meet the Illuminating Engineering Society of North America (IESNA) criteria for said fixtures described above, and the maximum lumens generated by each fixture shall not exceed five-thousand (5,000). In no case shall the resulting illumination exceed levels currently recommended by the IESNA in publication *RP-8, American National Standard Practice for Roadway Lighting*.
- c) Fixtures that emit more than three-thousand (3,000) lumens shall be shielded if adjacent to residential districts or uses.

14) NEON LIGHTING.

- a) Light sources consisting of glass tubes filled with neon, argon, krypton, or other similar gas (hereafter referred to as “neon lighting”) are excluded from shielding and line-of-sight requirements, however such lighting shall be included in the light trespass requirements of *Subsection 7.12(2)(a)*.
- b) For the purposes of this Ordinance, signs using neon lighting shall be considered internally illuminated signs and shall be subject to the requirements specified for internally illuminated signs in the *Dallas Sign Ordinance*.
- c) Neon lighting shall not be considered as security lighting.

15) SIGN ILLUMINATION

- a) Whenever an external artificial light source is used to illuminate a sign, such source shall be fully shielded. A receptacle or device housing a permitted light source shall be top mounted and directed below the horizontal, except for ground-mounted signs no higher than six (6) feet which may be illuminated with ground-mounted or bottom-mounted lighting fixtures.
- b) The average level of illumination on the vertical surface of an externally illuminated sign shall not exceed thirty (30) foot-candles, unless permitted ground-mounted or bottom-mounted lighting fixtures are used in which case the average level of illumination on the vertical surface of the sign shall not exceed twenty (20) foot-candles. No exposed bulb or lamp shall be used on the exterior surface of any sign so as to expose the face of the bulb, light or lamp to any public right-of-way or adjacent property.
- c) Internally illuminated signs constructed with an opaque or colored background and lighter contrasting text or symbols are preferred; such construction shall be required for internally illuminated signs within six-hundred (600) feet of a Residential District. This section shall not apply to residential development identification signs, vending machines, telephone booths, time and temperature signs, or signs that do not exceed two (2) square feet in area. For the purposes of this Ordinance, signs using neon lighting shall be considered internally illuminated signs and shall be subject to the requirements specified for internally illuminated signs, provided that there shall be no color restrictions on neon signs.

## 16) OTHER OUTDOOR LIGHTING

- a) Outdoor lighting not otherwise specified in this Ordinance emitting more than one-thousand two-hundred (1,200) lumens (except motion detector activated lighting) shall be full cutoff and fully shielded. Bulbs in outdoor light fixtures emitting from six-hundred (600) to one-thousand two-hundred (1,200) lumens may be installed in fixtures that are not full cutoff and may be visible from the property line, provided, however, such bulbs shall be frosted glass or covered by frosted glass or other similarly translucent material.
- b) A spotlight or floodlight of less than one-thousand eight-hundred (1,800) lumens need not be full cutoff or fully shielded if its center beam is aimed at a point not beyond any property lines and no less than forty-five (45) degrees below horizontal, is used for security lighting purposes only, and is motion detector activated and cycles off within five minutes after the cessation of motion within its field of view. Such security lighting shall not be activated by normal business or resident activity.
- c) Tower or antenna lighting shall not be permitted unless required by the Federal Aviation Administration.
- d) The use of search lights, laser lighting, or lights that pulse, flash, rotate or simulate motion for advertising or promotions, and are therefore considered to be signs, are prohibited per *Section 9.14 Prohibited Signs of the Dallas Sign Ordinance*.

## 17) EXCEPTIONS

- a) The temporary use of low-wattage or low-voltage lighting for public festivals, celebrations, and the observance of holidays are exempt from this Ordinance except where they create a hazard or nuisance from glare. However, consideration to light trespass requirements shall be demonstrated prior to commencing the use of the temporary lighting.
- b) Emergency lighting and traffic control lighting shall be exempt from the requirements of this section.

## 18) LIGHTS NOT CONFORMING TO THIS SECTION

- a) Authority to Continue. Any lawfully installed lighting fixture at the effective date of this Ordinance which does not conform to the provisions of this section may continue provided the lighting remains in conformance with the provisions of this Subsection.
- b) Ordinary Maintenance and Repair. Nothing in this section shall relieve the owner or beneficial user of legal nonconforming lighting, or the owner of the property on which the legal nonconforming lighting is located, from the provisions of this section regarding safety, maintenance, and repair. Normal maintenance, including replacing light bulbs, cleaning, or routine repair of legal nonconforming light fixtures, shall not be deemed to be a condition which triggers a loss of lawful status described below, unless such maintenance increases the nonconforming aspects of the lighting.
  - i) Loss of Lawful Status
    - (1) Legal nonconforming status shall terminate under the following conditions:
      - (a) if a light fixture is no longer used for a period of six (6) months it shall be deemed abandoned and shall not thereafter be reestablished; or
      - (b) if a lighting fixture is structurally altered such that its nonconforming aspects increase; or
      - (c) if a lighting fixture is relocated, replaced, or moved in any way; or the lighting fixture is damaged and the cost of repair exceeds fifty percent (50%) of its replacement

value.

(2) Upon the event of any of the aforementioned, the lighting fixture(s) shall be immediately brought into compliance with this section, or the lighting fixture(s) shall be removed.

ii) Removal Pursuant to Public Order. Lighting found by a governmental agency to create public hazard can be ordered removed or altered at any time.

19) SECURITY LIGHTING. Security lighting shall be coordinated with other lighting on the property to the extent possible and shall otherwise conform with the following requirements:

a) Non-residential Lighting Fixtures. All security lighting in non-residential areas shall be shielded and specifically aimed so that illumination is directed only to the intended area. The light source for any security lighting shall include shields that prevent their light source or lens from being visible from adjacent properties and/or streets. Security lighting fixtures may be mounted on poles located no further than ten (10) feet from the perimeter of the area intended to be illuminated.

b) Residential Lighting Fixtures. Security lighting fixtures in residential areas shall make use of indirect and reflected lighting techniques to provide soft lighting under canopies, entry porches, or soffits.

20) TOWN CENTER

a) Storefronts shall be internally illuminated with spot or other incandescent lighting to display the business or its products.

b) Exterior lighting may be affixed to the building.

c) Pedestrian passages to parking areas on the sides and in the rear must be lit to a minimum of two (2) foot-candles.

21) MODIFICATION. The Planning & Zoning Commission, Zoning Board of Appeals and City Council shall have the authority to modify any of the requirements of this section.

Figure 7.9: Acceptable Lighting Examples

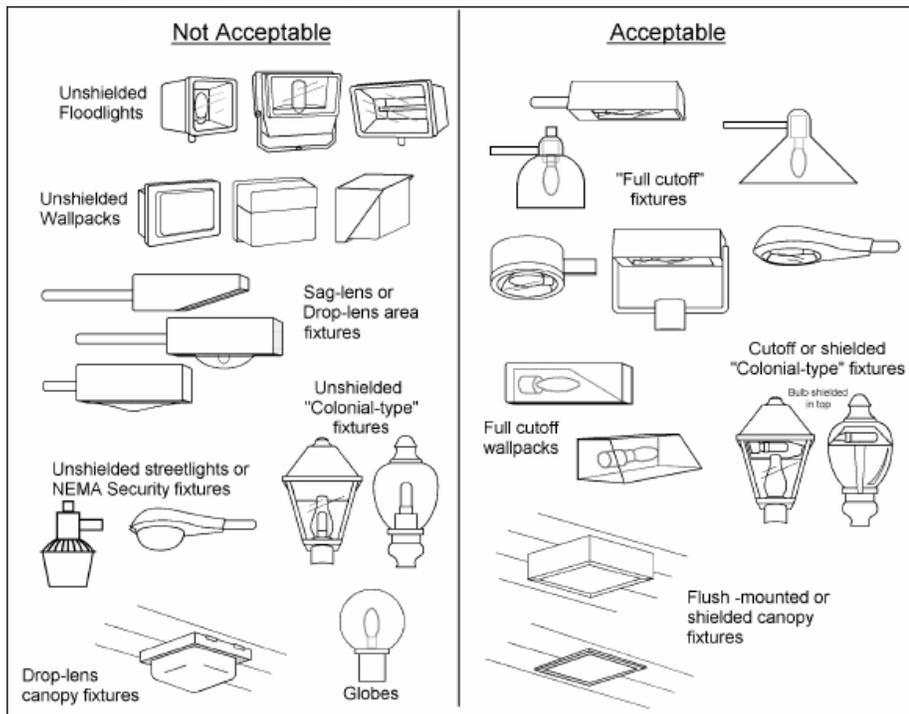

**Sec. 7.13 – OPEN SPACE REQUIREMENT**

---

- 1) INTENT. The following requirements shall govern the type and amount of open space for any tract of land which is the subject of an application for subdivision, land development or both using the provisions of this article. The purpose of open space is to regulate the intensity of development, preserve natural features and vistas, enhance the aesthetics of the built environment, and supply functional recreational areas.
- 2) OWNERSHIP. The land must be held in single and separate ownership by the applicant or, in the case of multiple ownership, the tract must be developed according to a single plan with responsibility for its implementation and completion vested in a common authority.
- 3) GENERAL PROVISIONS
  - a) Open Space shall be large, contiguous areas to the greatest extent possible.
  - b) Connectivity between the open space and adjacent development, greenways, parks and the like shall be provided by a minimum twenty (20) foot wide accessway.
  - c) Where significant natural assets exist in a proposed development, the Planning & Zoning Commission may require preservation. Areas devoted to natural or improved flood control channels and those sections subject to problems of flowage, floodway or drainage easements should be left in their unimproved, natural state.
  - d) Open space shall be designated as Common Area or placed in an easement.
  - e) The City Council shall require that a legal plan or contract for the perpetuation, maintenance and function of all the common area or other common property be established and furnished to the Council to be approved by the City Attorney prior to final approval. The legal plan or contract shall assure that all such common areas shall be provided for in a satisfactory manner without expense to the City. The documents shall be recorded in the County Recorder's office by the applicant prior to occupancy of any building on the project.
  - f) The City shall pursue enforcement of standards and impose penalties in accordance with *Chapter XII: Violations and Enforcement* upon failure to maintain designated open space and any improvements within the open space.
  - g) Further subdivision of the open space or its use for other than conservation, agricultural, or passive recreation shall be prohibited. Structures and buildings accessory to the conservation, agricultural or passive recreation may be erected on the open space, subject to the standards in *Table 4.4: Residential Lot Standards*, *Table 4.5: Non-Residential Lot Standards* (whichever table is applicable), and *Section 8.02 – Accessory Use and Structure Standards*, and subject to review of the site by the Planning and Zoning Commission. Any restrictions on the established open space shall be recorded in a conservation easement to which the City is a signatory party.
  - h) Where applicable, a homeowners' or maintenance association shall be established for the purpose of permanently maintaining all open space and potential non-commercial recreational facilities. Such homeowner's or maintenance association agreements, guaranteeing continuing maintenance, and giving lien to the City in the event of lack of such maintenance, shall be submitted to the City Council for approval prior to the issuance of any permits.
- 4) NON-QUALIFYING OPEN SPACE. Elements that do not qualify to be counted toward open space include:
  - a) Required detention and retention ponds that are not visually or physically accessible.
  - b) The floodway of any stream, regulated drain, river or other water body accessible.
  - c) Any area with slopes exceeding a twenty-five percent (25%) grade (must be protected).
  - d) Any wetlands on the development site, unless preserved as a conservation area.

5) MINIMUM REQUIRED OPEN SPACE

Table 7.24: Minimum Required Open Space		
Zoning District	Percentage of Open Space	Notes
R-1, R-2,	20%	-
R-3, TH, MF-1	20%	-
MF-2	20%	-
MXU, C-1, C-2, OMI	5%	-
I-1, I-2	2%	Sites less than 3 acres are exempt
CBD	-	Exempt

6) QUALIFYING OPEN SPACE

- a) Conservation areas and wetlands preserved as conservation areas.
- b) Floodplains
- c) Woodlands
- d) Riparian corridors
- e) Retention and detention facilities with the following characteristics:
  - i) Perimeter Access. An easement of at least fifteen (15) feet from the top of bank with a minimum five (5) feet wide path of a material that meets the requirements of the ADA.
  - ii) Access. An area of open space at least twenty (20) feet wide shall extend from a street right-of-way to the fifteen (15) foot perimeter access area of the detention area.
  - iii) Planting. Native plant material is encouraged around the perimeter of retention ponds.
- f) Development amenity areas containing semi-public areas such as:
  - i) plazas with seating and special features such as public art or fountains;
  - ii) pocket parks with seating and landscaping;
  - iii) decorative water features; and lakes.

**Sec. 7.14 – MULTIFAMILY AMENITIES REQUIRED**

- 1) Minimum Number of Amenities Required. Multi-family developments shall incorporate recreational amenities from the list in *Subsection 7.14(2)* below in the following amounts:
  - a) Multifamily development with fewer than twenty-five (25) units shall be exempt from this requirement. However, the Director may require an amenity not listed below to provide enhanced resident enjoyment and engagement.
  - b) Multi-family developments with twenty-five (25) to one-hundred (100) dwelling units shall provide at least one amenity;
  - c) Multi-family developments with one-hundred-one (101) to one-hundred and seventy-five (175) dwelling units shall provide at least two amenities; and
  - d) Multi-family developments with more than one-hundred and seventy-six (176) dwelling units shall provide at least three (3) amenities.

- 2) Allowable Amenities.
- a) Swimming pool;
  - b) Golf course or Putting green;
  - c) Resident clubhouse;
  - d) Pet park, minimum of two-thousand (2,000) square feet;
  - e) Community center (meeting room, assembly hall, etc.);
  - f) Community garden with raised beds;
  - g) Rooftop terrace;
  - h) Library/study;
  - i) Computer resource center/internet café;
  - j) Learning center/childcare;
  - k) Movie theater/virtual rooms
  - l) Koi pond/water gardens
  - m) Pocket parks Basketball, volleyball, or other sport court;
  - n) Nature trails Fitness center and/or recreation building;
  - o) Two tot lots with a minimum size of five-hundred (500) square feet per lot;
  - p) Two picnic areas, with a minimum size of five-hundred (500) square feet per area, and including a minimum of two picnic tables and one (1) grill/pit per area;
  - q) Exercise Room or area to measure no less than four-hundred (400) square feet.
  - r) Other amenity approved by city.
- 3) Amenity Standards.
- a) Each development shall satisfy its amenity area requirements by installing the types of facilities that are most likely suited to and used by the age bracket of persons likely to reside in that development;
  - b) Swimming pools shall be provided as a mandatory amenity first amenity in all applicable developments.
  - c) Except for developments which are expected to contain adults almost exclusively, a children’s play area shall be provided as a mandatory second amenity in the project.
  - d) Except for developments which are expected to contain adults almost exclusively, a sports court with a minimum size of thirty-six hundred (3,600) square feet shall be provided as second mandatory space in projects with more than forty (40) units. The minimum dimensions for the court active play area should be 72’X42’ feet (i.e. the dimensions for a youth basketball league half court). Substitution of the required court for a resident clubhouse would be acceptable.

### Sec. 7.15 – MULTIFAMILY DENSITY BONUSES

- 2) The following density bonuses may be used to achieve a maximum fifty percent (50%) density bonus for MF-1 zoned properties, and up to twenty (20%) for properties zoned MF-2 and TH.
- a) Structured Parking Bonus. The City may allow a two percent (2%) increase in permitted density for each five percent (5%) of units provided with structured parking.
  - b) Recreation/Open Space Bonus. The City may approve a one (1%) percent increase in permitted density for each one (1%) percent of useable recreation space set aside provided above the minimum amount required per *Sec. 7.13 – Open Space Requirement*.
    - i) Recreation areas shall be landscaped and provided with sufficient natural or manmade screening or buffer areas to minimize any negative impacts upon adjacent residential uses;
    - ii) Each recreation area shall be centrally located and easily accessible by walkways;
    - iii) Each recreation area shall be constructed on land that is reasonably flat, dry, and capable of serving the purpose that it was intended for.

- c) **Amenity Bonus.** The City may approve a five (5%) percent density bonus for every amenity provided in excess of the required amenities in *Subsection 7.14(2) Building Design Bonuses*.
  - a) The city may approve up to a ten percent (10%) increase in permitted density for multi-family development in which each multi-family building has brick and/or stone as its primary exterior building material, when an amount equal to sixty (60%) percent of the total net exterior wall area of each building elevation (excluding gables, windows, doors, and related trim), shall be brick, stone, fiber cement siding, or hard-coat stucco. For more contemporary-designed structures, the use of alternative high-quality finishes may be employed at the discretion of the Community Development Director.
- d) **Electric Vehicle Charging Station Bonus.** The City may approve a 3% density bonus for every electric vehicle charging station provided in excess of the number required by Section 8.30 *Electric Vehicle Charging Stations*.

#### **Sec. 7.16 – SINGLE-FAMILY DEVELOPMENT AMENITIES REQUIRED (R-1, R-2, R-3, TH, AND PUD)**

- 1) **Minimum Number of Amenities Required.** Single-family residential subdivisions, either attached or detached, shall incorporate recreational amenities from the list in Subsection 2. Below in the following amounts:
  - a) Developments with fewer than twenty-five (25) dwelling units shall be exempt from this requirement; except that the Director may require an amenity not listed in this section to provide enhanced resident enjoyment and engagement.
  - b) Developments with twenty-five (25) to one hundred (100) dwelling units shall provide at least one amenity;
  - c) Developments with one-hundred one (101) to one-hundred seventy-five (175) dwelling units shall provide at least two (2) amenities; and
  - d) Developments with one-hundred seventy-six (176) or more dwelling units shall provide at least three (3) amenities and the City Council shall determine the ratio of additional recreational amenities based on National Recreation and Park Association ([www.nrpa.org](http://www.nrpa.org)) standards.
- 2) **Allowable Recreational Amenities:**
  - a) Swimming pool sized to comply with NRPA standards.
  - b) Golf course.
  - c) Resident clubhouse.
  - d) Two tot lots with a minimum size of five-hundred (500) square feet per lot.
  - e) Basketball, volleyball, or other sport court.
  - f) Two picnic areas, with a minimum size of five-hundred (500) square feet per area, and including a minimum of two picnic tables and one (1) barbeque grill/pit per area.
  - g) Other amenity approved by the City Council.
- 3) **Density Bonuses for Single-Family Development:**
  - a) City may approve a five (5%) percent density bonus for every amenity provided in excess of the required amenities indicated in subsection 7.16(2) above, not to exceed a maximum of density bonus of twenty (20%) percent.

Figure 7.10: Density Bonus Foundations



A **density bonus** is an incentive-based tool that permits a developer to increase the maximum allowable development on a site in exchange for either infrastructure commitments or in-kind support for specified public policy goals.

### **Sec. 7.17 – MULTI-FAMILY AND TOWNHOME LAYOUT AND SITE PLANNING**

- 1) **APPLICABILITY.** All new multi-family developments (apartments, townhomes) of three (3) units or more are subject to the following standards.
- 2) **LAYOUT AND SITE PLANNING.**
  - a) **Topography.** Buildings shall be sited in relation to topography of the site, which minimizes cut and fill and limits maximum on-site slope to ten (10%) percent.
  - b) Attempts shall be made to preserve existing vegetation and natural features.
  - c) **Building Orientation.** Accessory buildings, including residential garages, storage buildings, etc., shall be located behind the primary building. No primary or accessory building shall have service doors, loading doors, or similar service entrances opening toward or oriented to a public or private street.
  - d) Distances between buildings shall be measured by a line perpendicular to the plane of the surface windows or exterior walls. There shall be a minimum of twenty (20) feet between any two (2) buildings in all directions provided that a two (2) hour fire wall is provided on both buildings constructed of brick and mortar, otherwise the buildings shall be thirty (30) feet between any two (2) buildings in all directions.
  - e) The maximum length of a multi-family building shall not exceed one-hundred ninety-two (192) feet. No more than eight (8) townhome units shall be attached in a single row.
  - f) Off-street parking, driveway, drive aisles, carport, garage or service facilities may encroach into the side or rear yard as specified in but shall be no closer than ten (10) feet to any lot line. In no event shall parking be located in required landscaping areas.
  - g) All sides of a building shall display a similar level of architectural features and materials.
- 3) **OPEN SPACE.** Open space shall be required in conformance with *Section 7.13 – Open*

Space Requirements and the requirements of the Zoning Ordinance.

- 4) VEHICULAR AND PEDESTRIAN CIRCULATION. Create a hierarchy of internal drives.
  - a) Drives shall be a minimum of twenty (20) feet wide. The City may request wider drives if on-street parking is permitted.
  - b) Multi-family developments with one-hundred fifty (150) units or more shall have at least two
    - a) points of ingress/egress.
  - c) The internal “street” system shall connect to surrounding neighborhood and local streets.
  - d) All internal sidewalks shall be a minimum of five (5) feet wide.
  - e) All internal sidewalks shall connect to adjacent residential areas, commercial areas, schools, parks, places of worship, and similar publicly accessible uses.
  - f) Driveway Depth. All driveways for individual townhome units are required to be at least 35’ in depth from the edge of pavement of all public or private roadways should sidewalks be present. For developments without sidewalks, a minimum depth of 40’ from the edge of pavement is required.

#### **Sec. 7.18 – COMMERCIAL AND INDUSTRIAL LAYOUT AND SITE PLANNING**

---

- 1) APPLICABILITY. All commercial and industrial developments shall meet or exceed the requirements of this section, in addition to all other applicable development standards established by this Ordinance.
- 2) SITE LAYOUT
  - a) Site planning which encourages compatibility between the site and the buildings and between all buildings on the site is encouraged. Where natural or existing topographic patterns contribute to a development, they shall be preserved and integrated. Modification to topography shall be permitted where it contributes to the overall development.
  - b) The orientation of buildings shall promote interaction with the street or city road and provide a pedestrian friendly environment. All primary and outparcel site buildings shall be arranged so that they complement existing development. The buildings shall frame a corner or enclose a “main street” type corridor. Buildings on islands surrounded by parking should be avoided.
  - c) Newly installed infrastructure and service revisions necessitated by exterior alterations shall be underground. To the extent possible, all existing overhead utilities shall be relocated underground.
- 3) ACCESS. Major and minor arterials and major collector streets must have reasonable restrictions as to the numbers and location of access points. To provide safe and sufficient traffic movement to and from adjacent lands:
  - a) Frontage roads, access roads, and other internal drives shall be constructed to create a hierarchy of roads for safe on-site circulation. These internal drives shall provide pedestrian access and landscaping.
  - b) Shared access shall be coordinated with contiguous lots. Access at the side or rear of buildings is encouraged.
  - c) New access points onto the major and minor arterials shall be coordinated with existing access points whenever possible and approved by the City Engineer.
  - d) Cross-access easements shall be required between adjacent compatible developments.

- i) All curb cuts shall meet horizontal and vertical sight distance requirements as set forth in *Chapter 34 Subdivisions* of the City of Dallas Code of Ordinances. The distance from the centerline of the driveway entrance to the centerline of the nearest street intersection shall not be less than 150 linear feet.
  - ii) Opposing curb cuts shall align squarely or be offset no less than one-hundred twenty-five (125) feet.
  - iii) Stub Streets shall be built in all cases where adjacent lots have reasonable potential for development.
  - e) Entry Drive. The commercial entry drive should be appropriate to the size of the development, incorporate signage, lighting, street trees, landscaping and set the tone for the development.
  - f) No buildings or paved areas (other than access drives) may be located closer than fifty (50) feet to any area used or zoned for residential purposes.
- 4) CART CORRALS. Cart corrals for developments over fifty-thousand (50,000) square feet shall be curbed, and may be landscaped and covered.
- 5) PEDESTRIAN FACILITIES.
- a) A connection shall be established from abutting streets with sidewalks to the entrance of primary structures through the use of sidewalks and special demarcation.
  - b) Pedestrian areas in parking lots or across interior drives shall be demarcated with special paving, color or height change, or striping for increased safety.
  - c) Sidewalks shall be a minimum of six (6) feet wide and shall connect the commercial areas to adjacent residential, office and recreational uses.
  - d) Sidewalks in Industrial Districts shall be required on at least one (1) side of each street.
  - e) Sidewalks adjacent to customer entries shall be a minimum of eight (8) feet wide.
- 6) ELECTRIC VEHICLE CHARGING STATIONS. Electric Vehicle Charging Stations shall be required as provided in Section 8.30 *Electric Charging Stations*.

CHAPTER VIII – SUPPLEMENTARY CONDITIONS FOR SPECIFIC USES

**Sec. 8.01 – GENERAL CONDITIONS**

All uses shall be developed, used and operated in conformance with the standards of this Code. The following additional standards shall apply to the specific land uses listed in this article. Certain uses require a Special Exception in conformance with *Section 11.09 – Special Exception Procedure* – of this Code. All uses shall comply with applicable building, life safety, fire and health codes adopted by the City in addition to applicable regulations of Paulding County, and state and/or federal governments. The applicant shall provide evidence of compliance with the applicable requirement. The applicant shall obtain a business license and a home occupation permit, if applicable, prior to establishment of the use.

- a. All changes of use proposed within existing structures on developed parcels shall be exempt from all supplementary regulations within this ordinance except parking, lighting and landscaping requirements.
- b. All changes of use proposed within new structures or structures expanded beyond 35% of the existing structure’s square footage on developed parcels shall be subject to all applicable regulations within this ordinance as set forth herein.
- c. All changes of use proposed within existing buildings, new buildings, or buildings expanded beyond thirty-five percent (35%) of the existing structure’s square footage, and located on underdeveloped or undeveloped lots shall be subject to all applicable regulations within this ordinance as set forth herein.

Table 8.0: Change of Use Chart

	Undeveloped Lot	Underdeveloped Lot	Developed Lot
Existing structure	N/A	All regulations	Parking, Lighting and Landscaping Regulations
Expansions beyond 35% of a structure’s square footage	N/A	All regulations	All regulations
New Structure	All regulations	All regulations	All regulations

**Sec. 8.02 – ACCESSORY USE AND STRUCTURE STANDARDS**

- 1) GENERAL PROVISIONS. the following standards shall apply within all zoning districts:
  - a) Order of Establishment. No accessory use or structure shall be permitted to be located, placed, or established on any lot prior to the issuance of a permit for a principal use or structure. all accessory uses and structures shall be permitted only in association with the principal use or structure.
  - b) Incidental to Principal. Accessory uses and structures shall be incidental and subordinate to, and commonly associated with the operation of, the principal use of the lot. This shall be shown through the height, area, bulk, extent and purpose to the principal use served and shall not exceed the required heights, setbacks, or area standards established by this section.

- c) Setback. Accessory structures shall be located no closer to the front lot line than the front building façade line of the principal use.
  - d) Separation. Any detached accessory structure shall be located:
    - i) a minimum of five (5) feet from any accessory or principal structure in residential zoning districts.
    - ii) a minimum of ten (10) feet from any accessory or principal structure in non-residential districts.
  - e) Height. Accessory structure height shall be in accordance with the *Table 4.4: Residential Lot Standards* and *Table 4.5: Non-Residential Lot Standards* unless specifically allowed as otherwise by this section or by the height exemptions of *Section 7.10 – Height Standards*.
  - f) Placement. Accessory structures shall not encroach upon any required landscaping buffer yards or easements. No accessory structures shall be placed in any operable septic fields or septic field easements.
  - g) Design Compatibility. Accessory uses and structures shall be compatible in design and material to the principal use on the lot on which it is situated.
  - h) Exemptions. Billboard structures shall be exempt from this code section, and are regulated under *Sec. 9.38 of the Dallas Sign Ordinance*.
- 2) PERMITTED ACCESSORY USES AND STRUCTURES. The Community Development Director shall determine whether or not accessory uses are permitted based on consistency of each use with the intent of the district in which it is located. Accessory uses and structures may include but are not limited to the following:
- a) Appurtenant Features. Such appurtenant features as walks, driveways, curbs, drainage installations, mailboxes, lamp posts, bird baths, and structures of like nature.
  - b) Fixed Structures. Outdoor fireplaces, doghouses, children’s play equipment when the lot requirements are adhered to.
  - c) Walls. Fences, walls, structural screens, retaining walls when they do not hinder vision clearance triangles or intersection visibility.
  - d) Plant Material. Trees, shrubs, flowers, or other plant material in any required front, side or rear yard provided that sight visibility triangles are not hindered.
  - e) Animals. Domestic pets provided the keeping of the animals is not for profit and not construed as a kennel. This section shall not be interpreted to permit horses and stables.
  - f) Sports Equipment. Portable sports goals provided they are not in the right-of-way.
  - g) Accessory Dwelling Units. It is the intent of this section to permit, in the correct context, secondary dwellings as an alternative single family living arrangement. It is the intent that the occupancy is associated with the primary dwelling, and that the dwelling be held to the standards below. The restrictions herein are designed so that it remains clear that the property is a single lot and use, that the accessory dwelling appear subordinate in size and/or location, and that any potential nuisance is mitigated.
    - i) an accessory dwelling unit is permitted as a Special Exception in certain districts.
    - ii) one accessory dwelling unit may be permitted either within an accessory structure or as an independent accessory structure.
    - iii) the owner(s) of the single-family lot upon which the accessory apartment is located shall occupy at least one (1) of the dwelling units on the premises.

- iv) occupation of accessory dwelling units may be limited by the City Council.
- v) the accessory dwelling unit shall not exceed seventy-five (75%) of the primary dwelling footprint and shall not exceed the greater of six-hundred (600) square feet and five (5%) percent of lot coverage.
- vi) an accessory dwelling unit shall be constructed no farther than one-hundred (100) linear feet from the primary/principal dwelling.
- vii) an accessory dwelling unit shall be constructed so as to maintain the appearance of the property as a residence and the approving body should consider *Section 9.01 – Residential Design Standards*.
- viii) a minimum of two (2) off-street parking spaces, including the driveway, shall be provided.
- ix) a screening plan shall be a part of the approval process.
- h) Family-Care Homes
  - i) Day-Care Home Standards. Child daycare homes shall meet the definition established by *O.C.G.A. 591-1-1* and shall be consistent with all applicable regulations of the State of Georgia. However, home daycare in residential districts requires a special exception, and activities associated with the operation shall not adversely impact the quality of life of adjacent property owners.
  - ii) Family Foster Homes. Foster family homes where children unrelated to the residents by blood or adoption are cared for.
  - iii) Elder Day Care homes. Elderly day cares homes shall be permitted provided that the maximum number of elderly persons receiving care, protection and supervision in any such home shall not exceed six (6) at any given time.
- i) Home Occupation/Home-Based Business. Home-based businesses shall comply with all applicable provisions of the home-Based Business Standards of *Section 8.11 – Home-Based Business*.
- j) Off-Street Motor Vehicle Parking and Loading Areas
  - i) Private residential garages and carports for the storage of motor vehicles are permitted, provided that such structures are accessory to private, residential uses, are used for the storage of motor vehicles, and are clearly accessory and not for commercial purposes.
  - ii) Storage or parking of recreational vehicles (including travel trailer, boat trailer and the like) in the open is permitted, subject to the standards in *Subsection 7.02(18)*.
- k) Multi-Family Dwelling Accessory Uses and Structures. Where multi-family dwellings are permitted, customary incidental uses and accessory structures including but not limited to management offices, sales offices, storage facilities, day-care centers, self-service laundries, fitness centers, community centers, and recreation centers, shall also be permitted, subject to the following standards:
  - i) Area. The maximum cumulative area occupied by accessory uses and structures, including any associated parking shall not exceed ten percent (10%) of the park and development site.
  - ii) Subordinate Role. The accessory uses and structures shall be subordinate to the principal character of the development.
  - iii) Design Focus. The accessory uses and structures shall be located, designed and intended to serve only the needs of the development.
  - iv) Visibility. The accessory uses and structures shall present no visible evidence of their business nature to areas outside the multi-family or manufactured home park facility.

- v) Parking. Parking for accessory uses and structures shall be consistent with the Parking Standards of *Section 7.02 – Off-Street Parking and Loading*.
- vi) Display. There shall be no exterior display of vending machines and the like outside of facilities associated with multifamily or manufactured home park development.
- l) Swimming Pools
  - i) Private Swimming Pools. No private swimming pool, exclusive of portable swimming pools with a diameter less than twelve (12) feet or with an area of less than one-hundred (100) square feet, shall be permitted in any commercial or residential district, except as an accessory use and unless it complies with the following conditions and requirements:
    - (1) *International Swimming Pool and Spa Code 2021 (ISPSC 2021)*; and
    - (2) Application for a Land Disturbance Permit.
    - (3) Swimming pools shall not be allowed front yard areas, except on lots designated for a public or private pool as the primary use.
  - ii) Public Pools. Community or club swimming pools, where permitted, shall comply with the following conditions and requirements:
    - (1) The pool and accessory structures, thereto, including the areas used by the bathers, shall not be closer than fifty (50) feet to any property line; and
    - (2) The swimming pool and all of the area used by the bathers shall be walled or fenced to prevent uncontrolled access by persons from the street or adjacent properties. The fence or wall must be constructed in accordance with the *International Swimming Pool and Spa Code 2012 (ISPSC 2012)*, and be of a substantial material with openings (space between pickets) not greater than four (4) inches. Said fence or wall shall not be less than six (6) feet in height and maintained in good condition.
- m) Waste/Recycling Containers. All dumpsters and other waste/recycling containers shall be screened consistent with *Section 7.05 – Landscaping Standards*.
- n) Outdoor Storage, Sales, and Display. Outdoor storage of merchandise in commercial and industrial districts is permitted only as regulated in *Section 8.13 – Outdoor Sales, Display, and Storage Standards*. Accessory structures in commercial and industrial districts should not alter the character of the district.
- o) Park & Recreation Facility Accessory Uses & Structures. Where park and recreation facilities are permitted, customary accessory uses & structures including but not limited to rest rooms, groceries, refreshment stands, restaurants, laundries, and sporting goods sales are also permitted, subject to the following standards:
  - i) Area. The maximum cumulative area occupied by accessory uses and structures, including any parking intended for accessory structure use that is separate from park and recreation area primary parking, shall not exceed ten (10%) percent of the park and recreation site.
  - ii) Subordinate Role. The accessory uses and structures shall be subordinate to the recreational character of the development.
  - iii) Design Focus. The accessory uses and structures shall be located, designed and intended to serve only the needs of the park and recreation facility.
  - iv) Visibility. The accessory uses and structures shall present no visible evidence of their business nature to areas outside the park or recreation park facility.
  - v) Parking. Parking for accessory uses and structures shall be consistent with the standards of *Section 7.02 – Off-Street Parking and Loading*.

p) Solar Energy Conversion Equipment.

i) *Solar Energy System, Building Mounted.* A building-mounted solar energy system shall be subject to the following regulations:



- (1) A solar system, which may include solar thermal panels, solar hot water system panels, and photovoltaic panels, which are mounted to a building or structure, to provide energy primarily for onsite use. Building mounted solar panels may be flushed mounted (i.e., flush to the surface of a building roof or building façade in a manner that the panel cannot be angled or raised), or as one or more modules fixed to frames which can be tilted or automatically adjusted at an optimal angle for sun exposure. A mounted solar energy system is accessory to the building or structure.
- (2) *Location.* Subject to the following restrictions, building mounted solar energy systems shall be allowed in all zoning districts.
- (3) *Placement.*
  - (a) No solar energy system shall be mounted or affixed to any freestanding wall or fence.
  - (b) Panels and building mounts shall be installed per manufacturer's specifications.
  - (c) In residential zoning districts and in the central business district, a solar energy system for aesthetic reasons shall not be located on the front slope of a pitched roof unless no other location for the solar energy equipment is feasible. The City of Dallas may require sun and shadow diagrams specific to the installation to ensure compliance with this provision.
- (4) *Glare.* All solar panel energy systems shall be placed such that concentrated solar radiation or glare does not project onto nearby structures or roadways.
- (5) *Height.* With the exception of single-family residential detached structures, building-mounted solar panels or systems shall not exceed four (4) feet above the height of any principal building on the site. For single-family residential detached structures, the height of the solar panels cannot exceed the horizontal peak of the roofline to which they are attached.
- (6) *Permits and code compliance.* A building permit shall be required for installation of all building-mounted solar energy systems.

ii) *Solar Energy System, Ground Mounted.* A ground-mounted solar energy system shall be subject to the following regulations:

- (1) *Location.*
  - (a) Permitted Districts:
    1. C-2, Commercial Medium-Density
    2. PUD, (non-residential uses in a PUD) Planned United Development
    3. I-2, Industrial Medium –Density
    4. OMI – Office Medical Institutional
  - (b) Prohibited Districts:
    1. R-1, Single-Family Residential District
    2. R-2, Single-Family Residential District
    3. R-3, Single-Family Residential District
    4. TH, Townhome
    5. PUD, (residential uses in a PUD) Planned Unit Development
    6. MF-1, Multifamily, Low-Density

7. MF-2, Multifamily, Medium-Density
8. CBD, Central Business District
9. MXU, Mixed Use
10. C-1, Commercial Low-Density

(2) *Placement.*

- (a) A ground-mounted solar energy system shall not be located within the front yard set-back area set forth in Table 4.4 and 5.5 – Lot Standards. In district where no front yard set-back is required, the ground-mounted solar energy system shall not be located within 30 feet of the road fronting the piece of property.
- (b) A ground-mounted system shall not be located over a septic system, leach field area or identified reserve area unless approved by the health department.
- (c) If located in a floodplain or an area of known localized flooding, all panels, electrical wiring, automatic transfer switches, inverters, etc. shall be located above the base flood elevation.
- (d) Panels and ground mounts shall be installed per manufacturer's specifications.
- (e) All ground-mounted solar energy systems shall be placed so that concentrated solar radiation or glare does not project onto nearby structures or roadways.
  - (i) *Maximum area coverage.* A solar energy system shall not exceed fifty (50%) percent of the footprint of the principal building served. For residential properties located in agricultural districts, a ground-mounted solar energy system shall not exceed twenty-five (25%) percent of the footprint of the principal building served.
  - (ii) *Height.* The maximum height of a ground-mounted solar energy system shall not exceed the maximum building height for accessory buildings in the zoning district in which it is located, set forth in Table 4.4 and 5.5 – Lot Standards, or twenty (20) feet, whichever is less.
  - (iii) *Permitting.* A building permit is required for any ground-mounted solar energy system and for the installation of any thermal solar energy system.

iii) *Solar Energy Facility or Solar Farm.* In districts where permitted, a "solar energy facility" or "solar farm," as defined in Section 13.01 shall be subject to the following regulations:(1) *Location.*

- (a) Permitted Districts:
  - (i) I-2, Industrial Medium –Density
- (b) Prohibited Districts:
  - (i) R-1, Single-Family Residential District
  - (ii) R-2, Single-Family Residential District
  - (iii) R-3, Single-Family Residential District
  - (iv) TH, Townhome District
  - (v) PUD, Planned Unit Development
  - (vi) MF-1, Multifamily, Low-Density
  - (vii) MF-2, Multifamily, Medium-Density
  - (viii) CBD, Central Business District
  - (ix) MXU, Mixed Use
  - (viii) C-1, Commercial Low-Density
  - (ix) C-2, Commercial Medium-Density
  - (x) I-1, Industrial Low-Density

(2) *Mounting.*

- (a) Solar panels or solar arrays shall be mounted onto a pole, rack or suitable foundation, in accordance with manufacturer specifications, in order to ensure the safe operation and stability of the system. The mounting structure (fixed or tracking capable) shall

- be comprised of materials approved by the manufacturer, which are able to fully support the system components, in accordance with applicable building permit requirements. Electrical components of the facility shall meet applicable electrical code requirements, and all electrical wires and lines less than 100kV that are used in conjunction with the solar energy facility shall be installed underground.
- (b) Multiple mounting structures shall be spaced apart at the distance recommended by the manufacturer to ensure safety and maximum efficiency.
- (3) *Setbacks.*
- (a) A solar energy facility and its appurtenant components and structures shall be set back a minimum of fifty (50) feet from all property lines and 100 feet from any residence.
- (4) *Placement.*
- (a) When located in agricultural zoning districts, the solar energy facility shall be located as much as possible to minimize impacts on prime agricultural soils.
- (b) If located in a floodplain or an area of known localized flooding, all panels, electrical wiring, automatic transfer switches, inverters, etc. shall be located above the base flood elevation.
- (c) Components of the facility shall not be located over a septic system, leach field area or identified reserve area unless approved by the County Health Department.
- (5) *Screening.*
- (a) The facility shall be fully screened from adjoining properties and adjacent roads using the natural topography or by installation of an evergreen buffer capable of reaching a height of six (6) feet within three (3) years of planting, with at least seventy-five (75%) percent opacity at the time of planting.
- (6) *Height.*
- (a) Freestanding solar panels or solar arrays shall not exceed twenty-five (25) feet in height as measured from the grade at the base of the structure to the highest point.
- (b) Mounted solar panels or solar arrays shall not exceed eight (8) feet above the apex of the structure on which it is mounted or the maximum height for buildings in the zoning district in which it is located.
- (7) *Security.*
- (a) Unless 24-hour security guards or video surveillance is provided at the installation, the solar energy facility shall be enclosed by a security fence no less than six (6) feet nor greater than eight (8) feet in height.
- (b) Access gates and equipment cabinets must be locked when not in use.
- (8) *Noise.*
- (a) Inverter noise shall not exceed 40dBA, measured at the property line.
- (9) *Glare and lighting.*
- (a) The solar energy system components shall be designed with an antireflective coating or at least shall not produce glare that would constitute a nuisance to occupants of neighboring properties, aircraft, or persons traveling adjacent or nearby roads.
- (b) If lighting is required, it shall be activated by motion sensors, fully shielded and downcast type where the light does not spill onto any adjacent property or into the night sky.
- (10) *Maintenance and upkeep.*
- (a) Systems shall be maintained in accordance with manufacturer's specifications. The operator of the facility shall maintain the facility, including all buffer screening, in compliance with the approved plans and shall keep the facility free from weeds, dust, trash and debris.
- (11) *Site plan review and development permit.* A site plan reviewed and approved by the planning division shall be required prior to issuance of a development permit. In

addition to requirements for site plans generally, the site plan submission shall include the following information: The proposed location and dimensions of all solar panels, inverters, existing and proposed structures, screening, fencing, property lines, parking, access driveways and turnout locations, ancillary equipment, transmission lines, vegetation, the location of any residences on site and within one-hundred (100) feet of the perimeter of the facility, the location of any proposed solar access easements, and standard drawings of solar energy system components.

- (12) *Additional submission requirements.* In addition to requirements for information to be provided during the site plan review and development permitting process, the facility shall not be approved for operation until the following are submitted:
- (a) Copy of all lease agreements and solar access easements.
  - (b) Where interconnection to an electric utility grid is proposed, the applicant shall submit evidence that the electrical utility provider has been informed of the customer's intent to install an interconnection with the local electric utility grid. A copy of the approval from the local utility must also be provided before operation of an interconnected facility will be authorized.
  - (c) A decommissioning plan for the anticipated service life of the facility or in the event that the facility is abandoned or has reached its life expectancy.
  - (d) The city may require other studies, reports, certifications, and/or approvals be submitted by the applicant to ensure compliance with this section.

iv) *Decommissioning.*

- (1) The owner of a solar electrical system is required to notify the city immediately upon cessation or the discontinuation of the operation. The solar electrical system shall be perceived to be discontinued or abandoned if no electricity is generated by such system for a period of twelve (12) continuous months.
- (2) The solar electrical system owner shall then have twelve (12) months in which to dismantle and remove the system including all solar related equipment or apparatuses related thereto included but not limited to buildings, cabling, electrical components, roads, foundations and other facilities from the property. If the owner fails to dismantle and/or remove the solar electrical system within the established time frames, the municipality may complete the decommissioning at the owner's expense.

q) Wind Energy Conversion Equipment.

- i) *Noncommercial Wind Energy Conversion Systems.* Wind energy conversion systems are permissible up to one-hundred twenty (120) feet in height in zoning districts where they are allowed. For propeller turbines, the height shall be measured from the rotor blade at its highest point to the top surface of the wind energy conversion system foundation. For vertical axis turbines, the height shall be measured from the highest point of the unit to the top surface of the wind energy conversion system foundation.
- ii) Rooftop mounted wind energy conversion systems may exceed the permitted height standards for the zoning district in which they are located by up to ten (10) feet.
- iii) Air Space Requirements. Nothing in this Ordinance, including the exceptions listed above shall be interpreted as waiving any height regulations related to air transportation. All applicable Federal Aviation Administration (FAA) and State of Georgia restrictions and regulations, including *Federal Aviation Regulation Part 77* and *Objects Affecting Navigable Airspace (FAR Part 77)* shall apply to all structures.
- iv) Inverter noise shall not exceed 40dBA, measured at the property line.

- r) Communication Facilities. Satellite dishes or satellite or television antennas or amateur radio equipment in accordance with *Section 7.11 – Wireless Communication Facilities.*
- s) Building Features. Buildings and structures such as awnings, canopies, porte-cocheres, and similar provided that:
- i) the bottom of the structure shall be no less than eight and one-half (8½) feet above the grade over a pedestrian way, or no less than twelve (12) feet above the grade over a driveway or interior access drive (e.g. drive through window); and
  - i) the maximum projection of an awning and / or canopy shall:
    - (1) not extend more than eight (8) feet from or behind the facade of its supporting building, and;
    - (2) not extend any closer to an imaginary perpendicular vertical plane located at the edge of pavement, curb or outside edge of a sidewalk than three (3) feet.
- t) Accessory Structures in Residential Zoning Districts.
- i) Applicability.
    - (a) ACCESSORY STRUCTURE (DETACHED) - In a residential district, a subordinate building detached and used for a purpose customarily incidental to the main structure such as a private garage for automobile storage, tool house, lath or greenhouse as a hobby (no business), home workshop, children's playhouse, storage house or garden shelter, but not involving the conduct of a business or a guesthouse residence.
    - (b) FARM ACCESSORY STRUCTURE - A structure, other than a dwelling, on a farm for the housing, protection or storage of the usual farm equipment, animals and crops.
    - (c) ACCESSORY USE - A use subordinate to and incidental to the primary use of the main building or to the primary use of the premises.
    - (d) EXEMPTIONS – Fences, flagpoles, raised garden beds, pergolas, arbors, and trellises are permitted in yards in all residential zones, and shall be exempt from this section. The Community Development Director shall have the discretion to make a determination of the classification of an accessory structure if not otherwise identified by type in the section. Accessory structures 200sf or less are exempt from permitting, but are subject to a minimum five (5) foot setback from the side or rear property line.
  - ii) Accessory structure or outbuilding shall be permitted at the owner's option according to the schedule presented in *Table A -- Total Aggregate Accessory Structure Allowance Based on Lot Size.*

Table A Total Aggregate Accessory Structure Allowance Based on Lot Size	
Lot size in square feet	Total aggregate accessory structure size based on lot size*
2,400	240
3,100	296
4,000	360
5,375	457
6,750	540
7,625	572
8,500	595
10,000	650
13,925	835
17,850	981
21,780	1,089
32,670	1,307
43,560	1,525
>1 ac.	Max 5%

\* In R-1, R-2, and TH zoning districts, accessory structures shall not exceed the greater of 5% of the lot area or 600sf.

- iii) Except as herein provided, the minimum yard requirements of *Table 4.4: Residential Lot Standards* of this chapter also apply to accessory structures. However, accessory structures may be located in rear yards within five feet of a rear or side lot line. In addition to these yard requirements, the horizontal separation of accessory structures from the dwelling on the same lot, and the horizontal separation of accessory structures from dwelling on adjacent lots shall comply with standards in *Table B—Distance Between Accessory Structures and Residential Dwellings on the Same Lot and on Adjacent Lots*. All distances shall be measured from outside wall to outside wall.

Table B—Distance Between Accessory Structures and Residential Dwellings on the Same Lot and on Adjacent Lots	
Percent of primary dwelling unit ground floor area of accessory structure	Distance between buildings
40 percent	10 feet
50 percent	30 feet
60 percent	50 feet
70 percent	70 feet
80 percent	80 feet
90 percent	90 feet
100 percent	100 feet

- iv) The number of accessory building may vary depending on the size of the lot. Table C—Maximum number of accessory structures establishes the schedule for number of accessory structures allowed on a building lot.

Lot size	Maximum number of accessory buildings
Up to one-half acre	1
Up to one acre	2
Over one acre	3

- v) Accessory structures, including detached garages, shall be permitted in an R-1, R-2, R-3, TH, MF-1, MF-2, and MXU Zone, subject to the following limitations:
- (a) Placement.
- i. Located on a lot with a principal dwelling. An accessory building shall be located on the same lot as the principal dwelling to which it is accessory.
  - ii. Setback dependent on distance from dwelling. Accessory structures shall be allowed in rear yards only. An accessory building located within twenty (20) feet of the principal dwelling shall comply with the setback requirements of the principal dwelling to which it is accessory. Accessory structures located more than twenty (20) feet from the principal dwelling may be placed five (5) feet from a side or rear lot line, except that accessory structure greater than two-hundred (200) square feet must maintain a minimum ten (10) foot side and rear yard setback.
  - iii. Setback on corner lot. Accessory structures on a corner lot shall comply with the setback for the principal dwelling. No accessory building on a corner lot that adjoins a residentially used or zoned lot to the rear shall be located within twenty-five (25) feet of the rear property line. This 25-foot setback will not be required when the adjoining yard is a rear yard.
  - iv. Distance from dwelling and other accessory structures. All accessory structures must be located a minimum of five (5) feet from the principal dwelling and all other accessory structures on the lot or on neighboring lots, in accordance with building separations indicated in Table B, as measured from outside wall to outside wall. In MF-1 and MF-2 zoning districts, the separation shall not be less than twenty (20) feet.
  - v. Ordinance setbacks otherwise remain in effect. Except as herein provided, the minimum setback requirements of *Table 4.4: Residential Lot Standards* of this chapter also apply to accessory structures.
  - vi. Non-complying accessory structures. Notwithstanding standards of this chapter to the contrary, nothing shall prohibit the re-construction of accessory structures that are legal, nonconforming structures that have been in existence for a minimum of twenty (20) years along that established building line. That building line shall be the minimum setback for re-building of the accessory building on the lot. All other standards of the chapter shall remain in effect.
- (b) Height.
- i. Scale of accessory structures. The height of an accessory building shall not exceed twenty-four (24) feet or the height of the principal dwelling measured from the average adjacent grade to the peak or ridgeline of the roof, whichever is less.

- (c) Architectural style and exterior finish.
- i. Compatibility with principal dwelling. Accessory structures shall be architecturally compatible with the principal dwelling on the lot. The exterior finish of all accessory structures shall be identical to the exterior finish of the principal dwelling on the lot. In the case of brick dwellings, the exterior finish of the accessory building may be similar to the trim work or other siding materials of the dwelling. Exterior materials, roof pitches and other design elements shall comply with the architectural design standards. Additions and accessory structures shall be consistent or complimentary to the scale and building proportions of the primary structure.
    1. A covered walkway or breezeway is allowed between a primary structure and accessory structure. Such connection shall not exempt the accessory structure from compliance with the standards of this section, unless the connection is fully enclosed and meets the building code definition of a conditioned space, and is all of the following, which results in an addition and is not an accessory structure:
      - a. Fully enclosed and meets the building code definition of a conditioned space; and
      - b. Provides a shared wall with the primary structure with the common wall being the longer of either twenty (20) feet in length or forty-percent (40%) of the overall length of the wall of the primary structure (see Figure 8.1); and
      - c. Provides for interior passage between the primary structure and the new structure.
    2. Design Standards
      - a. Metal siding is prohibited on structures more than ten (10) feet high or with a footprint greater than two-hundred (200) square feet, unless the siding replicates the siding on the primary dwelling or has the appearance of siding that is commonly used for residential structures.
      - a. Structures located in a front, side, or street side yard that are visible from the right-of-way at a pedestrian level shall use exterior siding and roofing materials that are commonly used on residential structures.
    3. Roof Pitch and Orientation
      - a. There are no roof pitch requirements for an accessory structure with a height equal to or less than ten (10) feet. A minimum 4/12 roof pitch is required for an accessory structure with a height over ten (10) feet.
      - b. Roof design. Flat or shed roofs shall be prohibited on accessory structures. Accessory structures shall have a gable or hip roof design.
      - c. Where possible, the orientation of the roofline of the primary structure should be at an architecturally consistent direction of the roofline of the primary structure.
      - d. Utility services.
        1. All utility services for an accessory structure, when utilized, shall be tied into the meter or utility infrastructure of the primary dwelling – and shall not be separately metered.

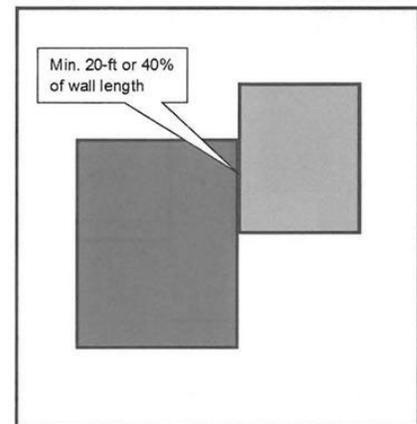

Figure 8.1: Primary Structure with Addition

- i. Water supply. Running water is permitted to all accessory structures.
    - ii. Electric supply. Power is permitted to all accessory structures.
    - iii. Sewer supply. Sewer is permitted to all accessory structures where public sewer is available.
  - (d) Use.
    - i. See section 8.02(2)g (accessory dwelling units (ADU)).
    - ii. Evidence of separate dwelling unit. The presence of such facilities or equipment as utility services, utility meters, mailboxes or kitchen equipment such as a sink, stove, oven or cabinets in an accessory building or a portion of a principal dwelling shall be considered prima facie evidence that such accessory building or such portion of a principal dwelling is a separate and distinct dwelling unit and is subject to the regulations of the zoning district in which it is located.
- u) Garage or yard Sales. A garage or yard sale is defined as a public or private sale or auction conducted by the owner or occupier of a premises, and conducted with a residence, garage, other accessory buildings or outside thereof, of six (6) or more items of personal property owned or in the possession of the owner or occupier of the premises, which personal property was not acquired by the owner or occupier for the purpose of resale.
  - i) Conducted a maximum of three (3) times in any one (1) calendar year or on any premises located in any residential zone, not be conducted for more than three consecutive days, and
  - ii) All personal property exhibited for sale outside any structure during a garage or yard sale or auction shall be removed from the outside and placed within a structure immediately following the last day of the sale. All signs erected for a garage or yard sale or auction shall likewise be removed within twenty-four (24) hours following the last day of the sale.
- v) Agricultural Structures. All structures, whether principal or accessory, used exclusively for agricultural purposes shall be required to obtain building permits and shall be required to file a plot plan as described in *Subsection 11.12(3)* for the construction of new structures.
- w) Roadside Stands.
  - i) Location.
    - (1) Stands shall be permitted as a special exception use on commercial properties zoned CBD, CMU, C-1, and C-2 provided the proposed location will not,
      - (a) result in increased traffic inappropriate to the area; or
      - (b) produce noise that disturbs the adjacent neighbors; or
      - (c) depreciate the value of neighboring properties.
  - ii) Commercial Activities.
    - (1) The area of where the products are displayed or sold shall not exceed eighty-hundred (800) square feet.
    - (2) The stand shall not occupy a designated parking space or isle, nor reduce the number of parking spaces required by the primary use on the lot of which it is located.
    - (3) At least fifty (50%) percent of the produce sold must be produced on land that is owned or leased by the operator of the stand.

- (4) Sales areas for accessory products shall be limited to twenty-five (25%) percent of the gross sales area.
  - (5) Accessory products include those products related to the care and culture of products produced on the farm, such as pottery, baskets, and garden accessories.
  - (6) Items sold shall be limited to farm produce, ornamental plants, flowers, hanging baskets, hand-crafted items, T-shirts displaying exclusively the name of the farm stand or other identifying information concerning the owner or operator of the farm stand, vegetable plants, herbs, honey, maple syrup, jams, jellies, bottled water, locally-produced juices and cider, locally-produced milk and other dairy products, relishes, pottery, locally-produced baked goods, locally-produced eggs, and similar items. Items which shall not be sold include, without limitation, tobacco products, alcoholic beverages, clothing, except as expressly allowed, bottled or canned beverages, except as expressly allowed, pet and animal feed, and repackaged relabeled goods.
- iii) Operations.
- (1) The stand shall be at least fifty (50) feet from an intersection and shall be at least twenty-five (25) feet from the edge of the legal right-of way line of any adjoining street.
  - (2) The stand shall be portable, shall be maintained in good condition, and shall be removed during seasons when products are not being offered for sale; except that, a stand may remain in place throughout the year if it would be located a minimum of one-hundred (100) feet from the existing street right-of-way line.
  - (3) Parking for vehicles shall be provided outside of the existing street right-of-way and in compliance with the provisions of *Section 7.02 – Off-Street Parking and Loading* of this Ordinance. Parking shall be provided for a minimum of five vehicles.
  - (4) Such activities shall be conducted only between the hours of 7:00 a.m. and sunset;
  - (5) Roadside stands shall be adequately served by public streets and highways. In no instance shall site access materially impede traffic flow on adjacent streets and highways, create a traffic hazard, or alter area traffic patterns.
- iv) Signage.
- (1) Signage related to the operation of a "roadside stand". Such signage shall relate to the sale of items produced on the premises. Such signage shall not be illuminated and shall be removed at the end of seasonal sales.
    - (a) Maximum number: One (1).
    - (b) Permitted placement: Building, ground or pole.
    - (c) Maximum area: Twenty (20) square feet.
    - (d) Minimum setback from street right-of- way: Ten (10) feet.
    - (e) Maximum pole or ground sign height: Six (6) feet from ground to top of sign.
- v) Exemptions. Roadside stands that operate less than fourteen (14) cumulative days per calendar year may be approved by the Community Development Director, subject to the regulations of *Subsection 8.02. (v)(iii-iv)* above.
- x) Nursing Homes
- iii) Minimum floor space for sleeping rooms shall be provided:
    - (1) Each room for one (1) person - 100 square feet;
    - (2) Each room for two (2) or more persons - 88 square feet per person;

- iv) All residential activities shall be conducted above ground floor, with the exception of storage, maintenance, or non-residential operational activities.
- y) Postal Service Delivery and Collection Structures
  - i) Single-Point Delivery – Mailboxes
    - (1) All mailboxes, whether installed on public or private streets, shall comply with the United States Postal Service (USPS) standards for the construction of mailboxes. A statement indicating the type of mail delivery available by the United States Postal Service (e.g., delivery to an individual mailbox or central delivery via cluster mailbox stations) shall be indicated on an approved subdivision plat or development permit.
    - (2) The property owner shall be responsible for the maintenance and repair of the mailboxes.
    - (3) Lateral placement of a non-cluster, individual mailbox shall be no more than six inches from the face of the curb or edge of pavement if no curb and gutter is present as defined by USPS installation requirements. In no case shall the face of the mailbox extend out over the face of the curb or edge of pavement if no curb and gutter is present.
    - (4) All monument-type or brick, stone, or masonry veneered mailboxes must be constructed with a hollow core. Concrete block construction is prohibited.
  - ii) Centralized Mail Delivery and Collection – Cluster Box Unit (CBU)
    - (1) General
      - (a) If required by the United States Postal Service (USPS), CBUs for commercial, industrial, and residential developments shall meet or exceed the standards of the USPS and meet the following additional requirements.
      - (b) During the design and planning phase (i.e., before plans and site plats are finalized with the appropriate planning/zoning authorities), developers and builders must notify the U.S. Postal Service of the planned development so that the Postal Service can determine the appropriate mode of delivery while considering input from the parties involved with the development.
      - (c) Installation of the mailbox unit(s), as well as any associated shelters, lighting, parking, and other related amenities shall be the responsibility of the developer.
      - (d) The mailbox unit(s) must be installed according to the manufacturer's standards.
    - (2) Location
      - (a) CBUs shall be located as follows:
        - i. Within a primary building, such as an apartment building, or an accessory facility serving the development such as a clubhouse;
        - ii. Stand-alone within twenty-five (25) feet of the parking area servicing such buildings or facilities; and/or
        - iii. CBUs and associated improvements that provide for access to the CBU shall be located within a common area or an access easement and are subject to approval of the public works department prior to installation. The area of each CBU located in common open space shall count towards any required open space for the development.
        - iv. CBUs, and any associated structures, shall not adversely impact sight distance to any driveway or road intersection, as determined by the City Engineer. Whenever

feasible, the mailbox unit should be located within an amenity center, if one is proposed for the development.

- v. All access to cluster mailbox unit(s) shall comply with current Americans with Disabilities Act and the Georgia Accessibility Code. Any sidewalks required by other provisions of this Ordinance shall be incorporated into the mailbox area(s).
- vi. The mailbox unit(s) and shelter, if any, shall be exempt from the normal setback requirements; however, shelters or other structures must be submitted to the building official for review and must meet all applicable building codes.
- vii. Cluster mailbox units shall be prohibited within the public right-of-way.

(3) Parking and Pedestrian Access

- (a) The number of motor vehicle parking spaces shall be provided per location, which shall include at least one space meeting handicap accessibility requirements.
- (b) No parking is required for CBUs located within a facility with parking or within twenty-five (25) feet of a parking area serving another facility.
- (c) Such facilities include, but are not limited to, clubhouses, leasing offices, and parking bays designated for visitor parking.
- (d) Such parking areas shall include a designated handicap accessible parking space in a location meeting USPS requirements.

Number of Mailboxes per Location	Minimum Number of Parking Spaces
50 or less	2
51 – 80	3
80 – 110	4
111 or more	4 plus 1 per each additional 25 mailboxes

(4) Pedestrian Access

- (a) Walkways or sidewalks shall connect mail stations to parking areas and the overall walkway and sidewalk system of the development.
- (b) All CBUs shall be accessed by walkways or sidewalks meeting handicap accessibility width and paving requirements.

(5) Maintenance

- (a) For townhome and detached developments, maintenance of the mailbox unit(s), as well as any associated shelters, lighting, parking, and other related amenities shall be the responsibility of the homeowners. The establishment of a homeowners' association is strongly encouraged in developments where individual mail delivery will be unavailable.

(6) Exemptions

- (a) New homes built or established within a block of existing homes can only receive the same type of mail delivery service as the older, existing homes after the Postal Service has completed an operational efficiency analysis. When new delivery replaces more

than 1 block, delivery methods must comply with mode of delivery options for establishment and extension of delivery service, which is typically centralized mail service.

- 3) ACCESSORY USES THAT ARE NOT PERMITTED. The following accessory uses are not permitted in any zoning district within Dallas City Limits.
  - a) Outdoor storage or property that is unusable, discarded or in a state of disrepair such as, but not limited to: junk, lumber, building materials, parking of inoperative vehicles, junk, abandoned or unlicensed motor vehicles, motor vehicle parts or similar items, shall not be permitted in any District unless specifically permitted by the specific zoning district regulations. For permissible outdoor storage, refer to *Section 8.13 – Outdoor Sales, Display, and Storage Standards*.
  - b) All wild and exotic animals that are inherently dangerous to humans shall be prohibited. All other wild and exotic animals shall be restricted to those requiring state or federal permits and Special Exception approval by the Planning Commission.
  - c) Motor vehicles used for storage.
  - d) Collection or donation bins, boxes, or structures where the owner/operator of the structure is located off site.

**Sec. 8.03 – TEMPORARY USE AND STRUCTURE STANDARDS**

---

- 1) INTENT. The purpose of these temporary use & structure standards is to establish minimum standards for the temporary use of property and the placement of temporary structures in order to:
  - a) accommodate the temporary needs or properties and land uses,
  - b) ensure that temporary uses do not become permanent without proper scrutiny, and
  - c) protect the public welfare from the unique hazards that can be created by temporary uses and structures.
- 2) GENERAL TEMPORARY USE AND STRUCTURE STANDARDS APPLICABLE TO ALL ZONING DISTRICTS
  - a) Temporary Structure Standards. All temporary structures shall conform to the following requirements:
    - i) Applicable Development Standards. Temporary structures must meet all development standards for a permanent accessory structure unless otherwise specified in this section.
    - ii) Temporary Structure Time Limits. Any temporary structure used for a permitted primary use may be permitted for up to two (2) years, unless otherwise specified by this ordinance.
    - iii) All temporary uses shall occur outside of the right-of-way.
  - b) Temporary Use and Structure Standards. Temporary uses and structures are permitted in any zoning district provided that the use is a permitted use in that zoning district. All temporary uses and structures shall conform to the following requirements:
    - i) Permit Requirements. All temporary uses and structures shall require a permit unless otherwise specified in this section. No temporary use or structure, or the related signs, lighting, parking, etc., shall be constructed or placed upon a site prior to all necessary permits being obtained.
    - ii) Time Limits. Temporary uses and/or structures that seek extensions of the initial time limits established in this section shall be subject to administrative approval.
      - (1) One (1) year extensions may be granted by the Director who may impose reasonable conditions as part of the approval.
    - iii) Removal. All temporary uses and/or structures must be removed and the site reverted to its original condition within the duration of the permit or any extension thereof.
  - c) Temporary Construction, Sales, or Leasing Trailers/Offices. Construction trailers are permitted as temporary structures during times of construction activity.
    - i) Specific regulations for temporary uses and structures. Factory-fabricated, transportable buildings that are designed to arrive at the site ready for occupancy, except for minor unpacking and connection to utilities, and designed for removal to and installation at other sites, may be placed on a property to serve as the following:
      - (1) Temporary offices used for on-site apartment leasing, real estate sales office, and model sales home;
      - (2) Temporary offices used during the expansion or rehabilitation of an existing non-residential use;
      - (3) Temporary offices for construction and security personnel during the construction of a development for which the city has issued a grading permit or building permit;
      - (4) Standards and requirements for approval. All temporary structures approved pursuant

to this section shall meet the following standards and requirements:

- (5) Location.
  - (a) Temporary structures allowed under Section 8.02 may be located anywhere on site, except within the following areas:
    - i. Existing vegetated buffers or within the buffer setbacks.
    - ii. Areas designated for future vegetated buffers whether or not vegetation currently exists.
    - iii. Other areas designated on the site and/or subdivision plan for open space, vehicular use, or ingress/egress.
  - (b) For uses other than leasing, sales, and construction activities occurring onsite, setbacks for accessory structures must comply with Tables 4.4 and 4.5.
- (6) Other requirements.
  - (a) The temporary structure shall be factory-fabricated and transportable.
  - (b) Underskirting shall be installed around all temporary structures requiring site plan approval.
  - (c) In addition to any other off-street parking required on the site, off-street parking shall be provided in accordance with the requirements set forth in Table 7.4.
  - (d) All permits required by applicable building, electrical, plumbing, and mechanical codes shall be obtained from the community services department prior to installation of the temporary structure.
  - (e) Foundation plantings installed in accordance with Section 7.05 shall be required for temporary structures intended for use as temporary offices, except when located on a paved surface or parking lot.
  - (f) A sketch plan containing sufficient information to show compliance with the above standards shall be submitted to and approved by the community services department prior to installation of the temporary structure.
  - (g) Temporary structures used during renovation of legally conforming or nonconforming structure shall be permitted so long as there is an active construction permit on file with the Community Development Department, not to exceed time limits established in the applicable code sections below.
  - (h) Temporary structures are not to include retail sales of new or used merchandise, or other uses not permitted within the zoning district where the structure is located.
- (7) Duration.
  - (a) Temporary offices used for on-site apartment leasing, real estate sales office, and model sales home are permitted until construction allows for a model/sales office to be opened onsite as determined by the community services director, at which time the temporary office shall be removed.
  - (b) All other temporary structures under this section may remain on the site for no more than twelve (12) months. This period may be renewed for up to two 12-month periods, for good cause shown, upon approval of a written request submitted to the Community Development Director thirty (30) days prior to the expiration of the

permit. In no event, however, shall such extensions allow the temporary structure to remain on the site for more than three (3) years.

- d) Construction Dumpsters. Dumpsters for construction-related debris shall be permitted as temporary structures during times of construction activity. Dumpsters shall not be located in any required setback, buffer yard, easement, or right-of-way.

i) Standards

- (1) Adequate access and off-street parking facilities shall be provided which shall not interfere with traffic movement on adjacent streets.
- (2) No public address systems or other noise-producing devices shall be permitted in a residential district.
- (3) Any flood lights or other lighting shall be directed upon the premises and shall not be detrimental to adjacent properties.
- (4) No banners, pennants, or unnecessary signs shall be permitted unless as otherwise specified. Refer to the *Dallas Sign Ordinance*.
- (5) The lot shall be put in clean condition devoid of temporary use remnants upon termination of the temporary period.

- 3) RESIDENTIAL TEMPORARY USE AND STRUCTURE STANDARDS APPLICABLE TO THE SINGLE-FAMILY RESIDENTIAL ZONING DISTRICTS. The following temporary uses and structures are permitted as described below; no permit shall be required unless otherwise specified.

- a) Garage/Yard Sales. Yard sales, garage sales, flea market sales and other similar permitted sales conducted in residential districts, shall be permitted no more than three (3) times in a calendar year and for no more than three (3) consecutive days. Garage/yard sales shall be distinguished from flea markets in that garage/yard sales are clearly incidental to residential uses, while flea markets are commercial businesses and primary uses. In no instance shall this provision be interpreted as permitting the operation of a flea market.

- i) All items of personal property sold at a garage and/or yard sale shall be owned by the owner or occupier of the premises or by a participant at the sale. Personal property for sale must not be property that has been acquired by the owner expressly for the purpose of resale.
- ii) All personal property exhibited for sale outside any structure during a garage and/or yard sale shall be removed from the outside and placed within a building immediately following the last day of such sale. All signs erected for such garage and/or yard sale shall likewise be immediately removed at the conclusion of the sale.

- b) Children’s Roadside Stands. Children’s roadside stands shall be permitted, but shall not be located in any public right-of-way.

- 4) SPECIAL EVENT. Definition. A Special event is an activity, not incidental to the primary use, conducted outside over the course of an established 180-day period. An activity conducted for more than the established 180-day period in a 12-month span shall be considered permanent.

- a) An event with at least one (1) component in the ‘City Council review’ line of *Table 8.01* must follow the process outlined in *Section 11.17 – Special Event Review Process*.

- b) The Community Development Director can require any proposal to submit to either review process as they deem it necessary.
- c) Exempt Events. Events that occur at City owned facilities and/or take place on the City right-of-way (public events, marathons, and other similar activities) shall be exempt from this ordinance and shall obtain permission from the City Council.
- d) Appeals of a City Council decision can be appealed to Paulding Superior Court.

Table 8.1: Special Event Process and Components						
		Components				
		Zoning District	Hours of Operation	Number of Vendors	Consecutive Days	Total Days in 180-Day Period
Process	By Right Permission	Permitted	Sun-Thurs 7A-8P Fri & Sat 7A-10P	<6	1 or 2	<10
	Administrative Review	Permitted	Sun-Thurs 7A-9P Fri & Sat 7A-11P	6-24	More than 2	10-120
	City Council Review	Special Exception or Not Permitted	Hours Beyond Administrative Review	24<	-	121-180

**Sec. 8.04 – SEXUALLY-ORIENTED BUSINESSES**

- 1) Purpose. It is the purpose of this Ordinance to regulate sexually oriented businesses to promote the health, safety, morals, and general welfare of the citizens of the City, and to establish reasonable and uniform regulations to prevent the continued deleterious location and concentration of sexually-oriented businesses within the city. The provisions of this Ordinance have neither the purpose nor effect of imposing a limitation or restriction on the content of any communicative materials, including sexually oriented materials. Similarly, it is not the intent nor effect of this Ordinance to restrict or deny access by adults to sexually oriented materials protected by the First Amendment, or to deny access by the distributors and exhibitors of sexually-oriented entertainment to their intended market. Neither is it the intent nor effect of this Ordinance to condone or legitimize the distribution of obscene material.
- 2) GENERAL PROVISIONS
  - a) All sexually-oriented businesses shall be permitted only as a Special Exception and shall require a Sexually-Oriented Business Permit to be obtained prior to establishment, location, or operation, and renewed annually.
  - b) Refer to *Section 11.15 – Sexually Oriented Business Permit* for permit procedures.
- 3) LOCATION OF SEXUALLY-ORIENTED BUSINESSES
  - a) A sexually oriented business shall not be located, established, operated within, or enlarged so as

to be within, one-thousand (1,000) feet of:

- i) A church;
  - ii) A public or private elementary or secondary school;
  - iii) A boundary of any residential district;
  - iv) A public park adjacent to any residential district;
  - v) A public library;
  - vi) A public or private recreation facility, not limited to the Boys & Girls Club, YMCA, or other facility that frequently attracts children;
  - vii) The property line of a lot devoted to residential use; or
  - viii) Any other sexually-oriented business.
- b) For the purpose of this Ordinance, measurement shall be made in a straight line, without regard to intervening structures or objects, from the nearest portion of the building or structure used as a part of the premises where a sexually-oriented business is conducted, to the nearest property line of the premises of any non-sexually-oriented business use listed in *Subsection 8.04(3)(a)* above. The distance between any two (2) sexually oriented businesses shall be measured in a straight line, without regard to intervening structures or objects, from the closest exterior wall of the structure in which each business is located.
- c) The establishment of more than one sexually-oriented business in the same building, structure, or portion thereof, or the increase of floor areas of any sexually –oriented business in any building, structure, or portion thereof containing another sexually oriented business, shall not be permitted.

#### **Sec. 8.05 – AMUSEMENT PARKS**

---

No amusement park facilities shall be located within one-thousand (1,000) feet of a residential district.

#### **Sec. 8.06 – BED AND BREAKFAST ESTABLISHMENTS**

---

In all districts in which bed and breakfast homes are permitted, the following standards shall apply:

- 1) The dwelling unit in which the Bed and Breakfast is operated shall be the principal residence of the operator(s) and said operator(s) shall live in the structure when the Bed and Breakfast is in operation.
- 2) The same rental occupants shall not reside at the Bed and Breakfast for more than seven (7) consecutive days.
- 3) The exterior appearance of the Bed and Breakfast is not altered from its residential character except for safety purposes.
- 4) Identification signage shall be no greater than six (6) square feet and shall not be internally lighted.
- 5) Cooking facilities are not permitted in individual guest rooms.
- 6) Parking provisions shall be in conformance with *Sec. 7.02 – Off Street Parking and Loading* of this Code.
- 7) In non-residential zoning districts, common dining areas for bed and breakfast inns may be leased for social events for a meeting/reception area only if off-street parking is provided for meeting and reception facilities in accordance with *Sec. 7.02 – Off Street Parking and Loading*.

- 8) In residential zoning districts, common dining areas shall not be leased for social events.
- 9) Bed and Breakfasts establishments shall:
  - a. Only serve food to overnight guests unless the establishment holds a valid Special Exception allowing restaurant operations;
  - b. Advertise as a bed and breakfast home, but not as a hotel, motel or restaurant;
  - c. Have a smoke detector in working order in each sleeping room;
  - d. Maintain a fire extinguisher in working order on each floor; and
  - e. Have the water tested annually by the local board of health if water is not received from a public water supply.

#### **Sec. 8.07 – CEMETERIES**

---

- 1) Location
  - a. No cemetery, whether public, private, or in conjunction with a religious institution, shall be located within a floodplain area as delineated by FEMA FIRM maps for the City of Dallas.
- 2) Minimum Size
  - a. Minimum lot size for a cemetery shall be five acres.

#### **Sec. 8.08 – CHILD CARE**

---

- 1) General
  - a) Family Day Care Homes and Day Care Centers shall comply with all applicable state laws and with the following requirements:
    - i) Applicant shall provide sufficient evidence that the proposed use will comply with all State and City regulations.
    - ii) The Family Day Care Home or Center shall be licensed by the state and the City.
    - iii) Play space shall be provided:
      - (1) Minimum outdoor play space: one-hundred (100) square feet per child excluding children in cribs. The area shall be fenced to a minimum of four (4) feet in height and shall not be permitted in the required front yard.
      - (2) Minimum indoor space: thirty-five (35) square feet per child. Calculation of the indoor space shall not include the kitchen, hallways and bathrooms, closets, utility rooms and offices.
    - iv) Home Day Care shall not be permitted where the operation of the business would have an adverse impact on adjacent properties, due to an increase in traffic, noise, trash or debris, or other nuisance originating from the business.
    - v) Home Day Care in residential zoning districts shall be required to have a Special Exception approved by the Planning Commission.
- 2) Family Day Care Home
  - a) Family Day Care Homes, as defined in *Chapter XIII*, may be located in the AG, R1, R2, and PUD zoning districts subject to a Special Exception pursuant to *Section 11.09 – Special Exception Procedure*. Family Day Care Homes shall comply with the following requirements:
    - i) No identification from a public street by signage, graphics, display, or other visual means is allowed.

- ii) The Chief Building Inspector may require that the number of children to be cared for on-site be less than that allowed by state or federal regulations if, in his opinion, the building cannot meet or exceed adopted life safety and fire code standards to adequately protect the number of children in care.
  - iii) The operator of a Family Day Care Home shall be a full-time resident of the home.
- 3) Group Day Care Homes and Facilities
- a) Group Homes, as defined in *Chapter XIII: Definitions*, shall comply with the following requirements:
    - i) An off-street passenger-loading zone shall be provided for the safe delivery and pick-up of passengers with a holding capacity of at least four (4) vehicles for any day care center or facility.
    - ii) A six (6) foot high opaque fence along all property lines abutting any residential use shall be provided.

#### **Sec. 8.09 – DRIVE-IN ESTABLISHMENTS**

---

- 1) Purpose
  - a) The purpose of these regulations is to provide standards for drive-in establishments to promote compatibility of this use with adjacent land uses and to ensure safe circulation of traffic on and off site. Drive-in establishments/uses include restaurants, banks and other financial facilities, automatic teller machines, cleaners, pharmacies and similar uses.
- 2) Applicability
  - a) All drive-in establishments/uses shall conform with the requirements of this Section.
- 3) Site Plan Requirements
  - a) Drive-in establishments/uses shall be shown on site development plans where they are proposed as an accessory use to a principal use.
- 4) Location
  - a) Drive-in establishments/uses as accessory uses shall not be located within the front yard of the principal building.
- 5) Stacking Space Schedule
  - a) The minimum number of stacking spaces required shall be as shown in *Table 8.2: Stacking Space Schedule* below. The number of stacking spaces required may be reduced or expanded in conformance with *ITE Transportation and Land Development (Stover and Koepke, 1988)* which is incorporated with reference hereto, upon recommendation of the Community Development Director.
- 6) Stacking Space Layout and Design
  - a) Stacking space design shall conform with the following minimum requirements:
    - i) Minimum Size: Eight (8) feet by twenty (20) feet per space.
    - ii) Minimum Setback from property line: Twenty (20) feet.
    - iii) Minimum Setback from street line: Forty (40) feet.
    - iv) Minimum drive-through lane turning radius: Forty-five (45) feet.

- 7) Entrances
  - b) Additional entrances shall not be permitted for drive-in structures unless recommended by the Community Development Director.
- 8) Order Box Noise Mitigation
  - c) The order box loudspeaker shall be positioned so that it is directed toward the vehicle and away from any abutting residential zoning district unless mitigated by a solid sound wall.
  - d) Buffering. The drive-in establishments/uses, including the stacking lanes, shall be buffered from abutting land uses with a buffer in conformance with *Section 7.08 – Tree Conservation, Buffers, and Landscape Compliance*.
- 9) Hours of Operation
  - e) Drive-in establishments/uses employing loudspeakers shall not be operated between 10 p.m. and 6 a.m. if abutting a residential district.

Table 8.2: Stacking Space Schedule		
Use Type	Maximum Spaces	Measured From
Drive-Through Automatic Teller Machine (ATM)	4/Lane	ATM
Bank Teller Window	4/Window	Teller Window
Car Wash, Automatic	6/Stall	Entrance
Car Wash, Self Service	2/Stall	Entrance
Gasoline Pump Island	2/Pump Island	Pump Island
Laundry/Dry Cleaners	4/Drive Service Window	Service Window
Pharmacy	3/Drive Service Window	Service Window
Restaurant, Drive Through	8/Drive Service Window	Service Window
Other Uses	Determined by Community Development Director based on ITE Transportation and Land Development stacking standards.	

**Sec. 8.10 – HOME-BASED BUSINESS**

- 1) Purpose. The purpose of this section is to provide standards for the operation of home-based businesses in order to protect the residential character of the neighborhood, preserve property values, and prevent the hazards to persons and property that result from residential-commercial land use conflicts, plus clearly establishing the secondary or incidental status of the home-based business in relation to the primary use for dwelling purposes.
- 2) Classifications. Home-based businesses shall be either permitted uses or special exception uses consistent with *Table 4.3: Permitted and Special Exception Land Uses* and shall abide by the provisions of this section. Home-based businesses are classified as either Home Occupation or Home Business, and their requirements are described as follows:
  - a) General Requirements.
    - i) Business Equipment. There shall be no equipment or process used in the home occupation or business which creates noise, vibration, glare, smoke, fumes, odors, electrical interference

- which is detectable at the property lines of the parcel on which the dwelling is located, or any other obvious objectionable activity.
- ii) Operator. At least one (1) person residing within the dwelling must be the primary operator of the home occupation or business.
  - iii) Outdoor Storage/Display. The home occupation or business must not involve any exterior storage of any kind, or the display of products, equipment or materials.
  - iv) Structural Alterations. The home occupation or business must not require any structural or aesthetic alterations to any structures that change its residential character.
    - (1) The dwelling shall not be altered in its appearance, and the home occupation or business shall not be conducted in such a manner as to differentiate the dwelling from the residential character of the area by use of colors, materials, construction, or lighting.
    - (2) The home occupation or business must not require increasing or enhancing the size, capacity, or flow of the water, gas, septic, sewer, or electrical system beyond what is standard for a residence.
    - (3) There shall be no alterations to the interior of the dwelling to accommodate a home occupation or business which would render the structure undesirable for residential use.
  - v) Entrances. The home occupation shall not require any additional entrances to the structure.
  - vi) Deliveries. The home occupation or business must not require the use of commercial vehicles for pickup and deliveries other than from the U.S. Postal Service, UPS, and other express couriers.
  - vii) Restrictions. Where applicable, a home based business may be restricted or prohibited by a Home Owners Association, Restricted Covenants, or other deed restrictions which may impact the business. If prohibited by neighborhood development controls, the City may not authorize a home business use where it is not otherwise allowed.
- b) Home Occupation. Home occupations are those which meet the following standards; representing requirements which permit minimal business practices within residential zoning districts while maintaining residential character. Home occupations shall be permitted without City approval.
- i) Business Type. The home occupation shall not involve retail sales or manufacturing, and shall be limited to small home-office operations.
  - ii) Business Equipment. The equipment used for the home occupation shall be limited to computers, fax business office equipment.
    - (1) There shall be no electrical or mechanical equipment utilized in the home occupation which will create any visual or audible interference with radio or television reception.
  - iii) Employees. The home occupation must not involve the on-site employment of any person other than those residing at the location of the home occupation.
  - iv) Business Area. The home occupation must utilize no more than twenty-five (25%) percent (of the total floor area of the dwelling. The home occupation shall not be conducted in any accessory structure.
  - v) Customers/Parking. The home occupation must not involve clients, associates, or persons shopping, meeting, or otherwise doing business at the location of the home occupation, and therefore not require the addition of any off-street parking spaces.
  - vi) Signs. No signs of any type, including signs located on vehicles, shall be permitted advertising the home occupation.

- c) Home Business. Home businesses are those which meet the following standards; representing requirements which permit reasonable business practices in certain residential zoning districts while maintaining residential character. Home businesses shall be special exception uses as regulated in *Section 11.09 – Special Exception Procedure*, and shall therefore require a Special Exception Permit.
  - i) Employees. The home business must not involve the on-site employment of more than one (1) person who does not reside at the location of the home business.
  - ii) Business Area. The home business shall be limited to the lesser of fifteen-hundred (1,500) square feet or twenty-five (25%) percent of the livable area for operation of the business, including storage, in the dwelling and/or any accessory structures.
  - iii) Customer/Parking. The home business must not require that more than two (2) additional parking spaces be added to the parcel on which the residence is located. All parking spaces shall be consistent with *Section 7.02 – Off-Street Parking and Loading*.
  - iv) Signs. One (1) sign for the home business shall be permitted in accordance with the *Dallas Sign Ordinance*. The sign shall not exceed six (6) square feet and shall not be illuminated, animated, or flashing. No off-site signs shall be permitted.
  - v) Commercial Vehicles. One (1) vehicle which does not exceed sixteen-thousand (16,000) pounds Gross Vehicle Weight is permitted.
  - vi) Business activities shall be conducted above ground floor, with the exception of incidental storage or production associated with the Home Business.
- 3) Prohibited Home-Based Businesses. The following uses, by the nature of the investment or operation, have a pronounced tendency, once started, to increase beyond the limits specified above for Home Businesses and impair the use, value, and quiet enjoyment of adjacent residential properties. Therefore, the following uses or similar uses shall not be permitted as Home Businesses:
  - a) Auto/Vehicle Sales, Service and Repair
  - b) Barber/Beauty Shop greater than a one (1) chair operation
  - c) Commercial Kennel
  - d) Freight, Trucking
  - e) Heavy Manufacturing
  - f) Landscaping/Nursery, Plant Materials
  - g) Restaurants, Eating or Drinking Establishments
  - h) Salvage Yards
  - i) Veterinary Clinic/Animal Hospital
  - j) Well Drilling/Contractor Storage Yard
  - k) Medical, Dental, Law, Insurance, or Real Estate Offices
  - l) Houses of Worship
  - m) Boarding House
  - n) Trailer Rentals
  - o) Welding Shops (not including private art studios)
  - p) Private Clubs
- 4) Special Exception Application Procedure. The special exception application procedure shall comply with *Section 11.09 – Special Exception Procedure*.
- 5) Interpretation. The Director of the Community Development Department, or other designated

person(s), may determine to what extent any proposed or existing home occupation or home business is consistent with the requirements of this section. The decision made by the Community Development Director may be appealed to the Zoning Board of Appeals in accordance with *Chapter II: Administration*.

Table 8.3: Home Based Business Standards			
Performance Standards	R-1, R-2, R-3 MXU	TH, MF-1, MF-2	PUD <sup>1</sup>
<b>Location of Operation</b>			
located in accessory structure	No	No	No
located in residence	Yes	Yes	Yes
<b>Customers</b>			
client visits allowed	Yes	No	Yes
1 client vehicle at a time	Yes	No	Yes
2 client vehicles at a time	No	No	No
up to five client visits per day	Yes	No	Yes
up to ten client visits per day	No	No	No
<b>Shipping Deliveries (excluding US Mail)</b>			
up to 2 per day	Yes	Yes	Yes
<b>Vehicular Size Limits</b>			
equipment or delivery vehicles limited to a maximum of 2.5 tons	Yes	Yes	Yes
<b>Maximum Area for Home Occupation</b>			
25% of residential floor area	Yes	Yes	Yes
up to 1,500sf of an accessory structure	No	No	No
<b>Animals</b>			
small animal grooming/training, no boarding	No	No	No
small animal boarding	No	No	No
<b>Non-Resident Employee Limits</b>			
all employees must be residents	Yes	Yes	Yes
up to 2 non-resident employees allowed	No	No	No
<sup>1</sup> Standards of Table 8.3 apply to Planned Development unless otherwise provided in the PUD approval.			

**Sec. 8.11 – NURSERIES AND GREENHOUSES**

No commercial nursery or greenhouse structure shall be located closer than one-hundred (100) feet to any adjoining property used or zoned for residential purposes.

**Sec. 8.12 – OUTDOOR SALES, DISPLAY, AND STORAGE STANDARDS**

- 1) GENERAL PROVISIONS. The following shall apply to all districts whether the use is permitted, Special Exception, accessory, or temporary:
  - a) Approved and documented permanent outdoor sales, display, and storage areas shall be permitted accessory uses, tied to the primary use.
  - b) Outdoor sales, display, and storage shall not be located in any setbacks, easements, right-of-way, or off-street parking or loading areas.

- i) Motor vehicle sales and display may be permitted in off-street parking areas.
- c) Lighting shall comply with *Section 7.12 – Outdoor Lighting*.

Outdoor sales, display, and storage shall be located behind the front or exterior wall of the main building facing any street and shall comply with all lot requirements of this ordinance and with intersection visibility standards as set forth in *Section 7.04 – Sight Visibility*.

Table 8.4: Open Storage by District and Location	
Base District	Permissibility of Open Storage
<b>Central Business District (CBD), Mixed Use (MXU), and Light Commercial (C1)</b>	All storage must be within an enclosed building except as specified for accessory outdoor display (limited to garden centers, plant nurseries, and lumber supply areas for home centers). Accessory outdoor display is subject to screening standards and to review and approval of a Special Use Permit.
<b>Office, Medical Institutional (OMI), All Residential (R-1, R-2, R-3, MF-1, MF-2)</b>	All storage, except as specified in this section, must be within an enclosed building, carport, or loading area.
<b>Commercial, Medium Density (C2) and Light Industrial (I1)</b>	Not permitted in front or street-facing side yards. Permitted in interior side and rear yards, or outside of required yards, subject to the standards of this Section.
<b>Industrial, Medium Density (I2)</b>	Permitted anywhere on a lot, subject to the standards of this Section.

- 2) SALES AND DISPLAY AREAS. Outdoor sales and display areas in compliance with the following requirements may be permitted in association with retail commercial uses.
  - a) All outdoor sales and display areas, regardless of size, shall be hard-surfaced, dust-free pavement and take into consideration soil conditions and traffic loading. Pervious pavements and pavers including durable materials, suitable for parking such as cobblestones, brick, concrete formed blocks or cut stone, the system of which is specifically installed and designed for vehicular loads shall also be considered. Sales and display areas shall be of concrete, asphaltic pavement, or other permanent paving material and shall be maintained in good condition.
  - b) The max area for outdoor sales and display shall not exceed ten (10%) percent of the primary structure or primary tenant space.
  - c) Every approved permanent outdoor sales and display area shall be in close proximity to the facade of the primary structure.
  - d) Screening shall be provided for outdoor sales and display area that are greater than five-hundred (500) square feet in size to reduce visibility of the outdoor sales and displays from the parking lot and primary roadways by installing a minimum twenty-four (24) inch opaque wall constructed from the same building material as the primary structure, and integrated into the design of the primary structure. The wall may be topped with a transparent fence.
  - e) Outdoor sale and display of merchandise within an area of five-hundred (500) square feet or less shall not block handicapped parking areas, parking lot access aisles, and shall maintain a forty-eight (48) inch clearance on all sidewalks.

- f) A Type 1 landscaped buffer yard as described in *Table 7.8: Applicable Buffer Yard Types* and *Table 7.9: Buffer Yard Types Description* may also be used. Plant material may be clustered for better view of displays.

Figure 8.1: Outdoor Sales Areas

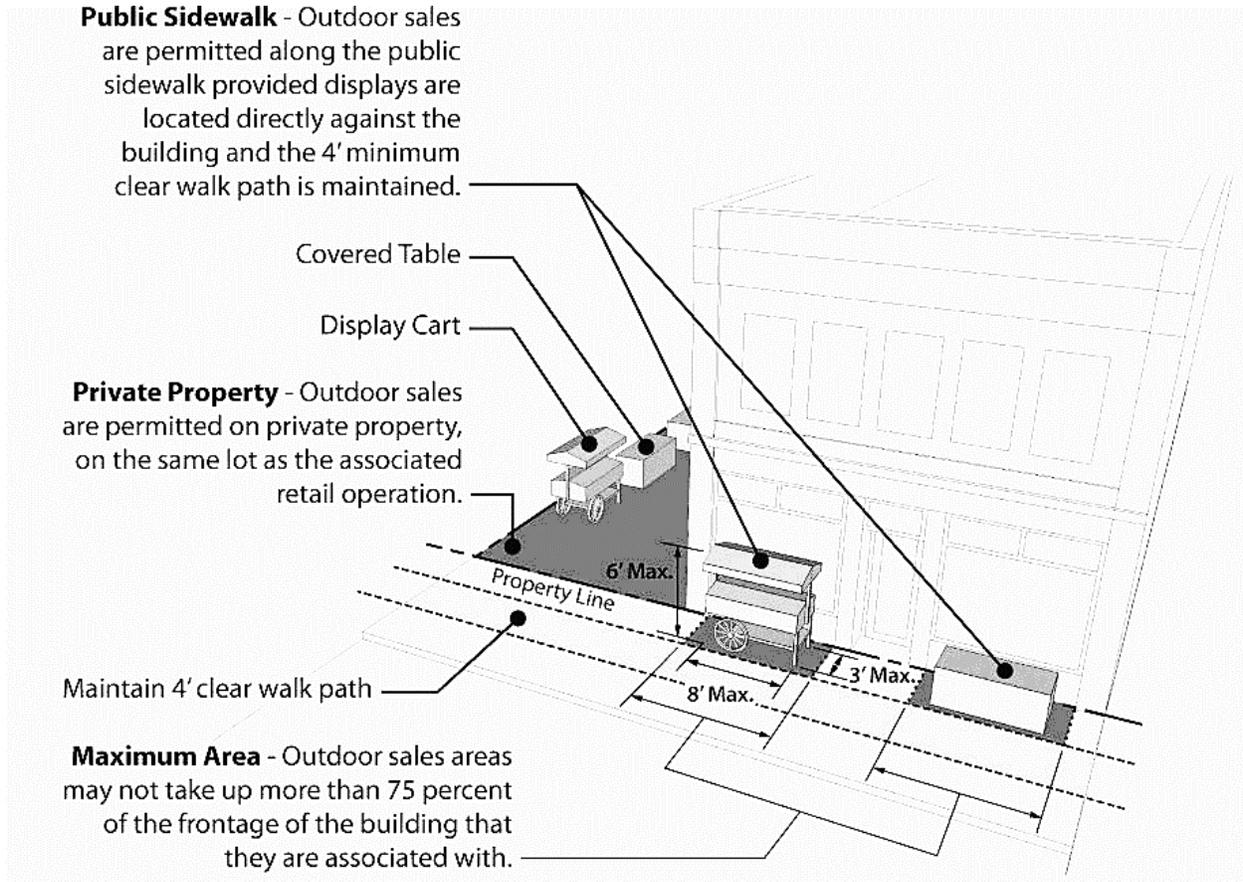

3) **OUTDOOR STORAGE.** Outdoor storage, in compliance with the requirements of this section is a permitted use and shall be considered primary or accessory to the principal use.

- a) General Standards that are applicable to all outdoor storage.
  - i) Screening. Outdoor storage of the types described below shall be screened with an opaque fence, split face block wall, continuous evergreen screen, or a combination of the three. The screen must measure a minimum of seven (7) feet in height. The fences or walls shall be compatible with or constructed from the same building material as the primary structure, and integrated into the design of the primary structure.
  - ii) Primary. Outdoor storage shall be permitted as a primary part of a permitted use in the I-1 and I-2 zoning districts.
  - iii) Accessory. Outdoor storage is accessory to a permitted principal use in all nonresidential districts when it does not exceed the greater of twenty-five (25%) of the building footprint or six hundred (600) square feet. All outdoor storage areas shall be paved.

- iv) All outdoor storage areas shall be paved.
  - b) Bulk Storage.
    - i) In any district in which bulk storage is permitted, structures, buildings, or aboveground tanks used for bulk storage of flammable or explosive liquids, gases, or other materials, shall be located no closer than fifty (50) feet to the property line.
    - ii) Additional information regarding evidence of safety measures may be required in order to determine the public safety therein.
- 4) VEHICLE DISPLAY AND SALES. Motor vehicle dealerships shall be exempt from *Subsection 8.13(2-3)*. the following regulations shall apply:
- a) Perimeter Landscaping
    - i) Any combination of materials selected from the landscape Materials Categories listed in *Table 7.10: Unit Value of Landscaping Material* which equals or exceeds a unit value of two-point-five (2.5) for each one-hundred (100) linear feet, along any exterior roadway, provided that at least fifty (50%) percent of the unit value shall be derived from Deciduous Shade trees (overstory) or Deciduous ornamental trees (understory).
    - ii) Any combination of materials selected from the landscape Materials Categories listed in *Table 7.10: Unit Value of Landscaping Material* which equals or exceeds a unit value of 6 for each one-hundred (100) linear feet, along any property that is zoned or used as residential, provided that at least fifty (50%) percent of the unit value shall be derived from evergreen trees and Shrubs or earthen Mounds.
  - b) Preparation, Repair, and Maintenance. The outdoor display, storage and parking of vehicles for sale shall be allowed, provided that all preparation, repair and maintenance of the vehicles shall be enclosed.
    - i) Special Lot Standards:
      - (1) Minimum Front Setback: twenty-five (25) feet
      - (2) Minimum Side Setback: ten (10) feet
      - (3) Minimum Rear Setback: fifteen (15) feet
  - c) All outdoor sales and display areas, regardless of size, shall be hard-surfaced. Pavement type and thickness shall be approved by the City Engineer, taking into consideration soil conditions and traffic loading. Pavers may also be used if approved by the City Engineer. Pavers shall include durable materials, suitable for parking such as cobblestones, brick, concrete formed blocks or cut stone, the system of which is specifically installed and designed for vehicular loads. Sales and display areas shall be of concrete, asphaltic pavement, or other permanent paving material and shall be maintained in good condition.
  - d) No outdoor storage shall occur within any setback, easement, or right-of-way.
- 5) MODIFICATION. The Planning & Zoning Commission, Zoning Board of Appeals and City Council shall have the authority to modify any of the requirements of this section in accordance with *Subsection 2.02(9)(a) ix*.

**Sec. 8.13 – PERSONAL CARE HOMES**

---

- 1) Personal Care Home Classifications:
  - a) Personal Care Home, Family - The Adult Family Care Home is a residential home designed to provide personal care services to individuals requiring assistance. The provider must live in the home and offers personal services for up to six (6) residents.
  - b) Personal Care Home, Group - A group home is a private residence model of medical care for those with complex health needs. Traditionally, the model has been used for children or young people who cannot live with their families, people with chronic disabilities who may be adults or seniors, or people with dementia and related aged illnesses. Group homes can accommodate between seven (7) through sixteen (16) persons.
  - c) Personal Care Home, Congregate - Congregate care is a placement setting that consists of 24-hour supervision for children in highly structured settings such as group homes, childcare institutions, residential treatment facilities, or maternity homes. For adults, a congregate living facility may include individual apartments, communal meals, housekeeping services and some assistance with activities of daily living (ADLs). The level of assistance is usually between independent living and assisted living. Congregate care facilities typically serve seventeen (17+) or greater numbers of residents.
- 2) Community residences, except those for senior citizens, shall be separated by a minimum of eight-hundred (800) feet.
- 3) Personal Care Homes shall comply with the *Rules and Regulations for Personal Care Homes, O.C.G.A 111-8-62*.
- 4) The location of Personal Care Homes is further outlines in *Table 4.3: Permitted and Conditional Land Uses*.

**Sec. 8.14 – PLACES OF WORSHIP**

---

- 1) Location
  - a) Places of Worship shall be permitted only on a lot which has frontage on or direct access to an arterial street as identified by functional classification of roadways in *Subsection 4.04(2)f(ii)*.
- 2) Parking
  - a) Off-street parking shall be provided as specified in the *Section 7.02 – Off-Street Parking and Loading* of this Code.
- 3) Setbacks
  - a) All buildings shall be setback thirty feet from the side and rear property lines.
- 4) Buffers
  - a) When a church adjoins a residential use, a buffer shall be provided within a thirty (30) foot setback area. (See *Section 7.08 – Tree Conservations, Buffers, and Landscape Compliance*)
- 5) Accessory Uses
  - a) A Special Exception shall be required prior to establishing school, over-night shelter, indigent food service or full-time child care facilities, subject to the requirements of *Section 11.09 – Special Exception Procedure*.

**Sec. 8.15 – SALVAGE OR JUNK YARDS**

---

- 1) Applicability.
  - a) An applicant proposing to establish a salvage or junk yard, as defined in *Chapter XIII: Definitions*, shall be required to obtain a Special Exception, in conformance with *Section 11.09 – Special Exception Procedure* of this Code. A salvage yard may be permitted with a Special Exception in the I-2 zoning district.
- 2) Guarantee Required.
  - a) The applicant shall post and maintain a guarantee with the City Clerk. This guarantee, approved in form by the City attorney, will assure the City that the applicant shall complete the plan for restoration for reuse, within one (1) year of discontinuance of the salvage yard. The amount of the guarantee shall be not less than the estimated cost of the restoration, and the amount of the estimate shall be approved by the Community Development Director. If the restoration is not completed within the specified time, the City may use the bond or any portion thereof to complete the restoration. Failure to maintain a guarantee shall be grounds for revocation of the Special Exception authorizing the use.
- 3) Performance Standards.
  - a) Minimum Lot Size
    - i) The minimum lot area for a junkyard or salvage operation shall be ten (10) acres.
  - b) Setbacks
    - i) No salvage materials shall be stored within twenty-five (25) feet of any property line.
  - c) Compatibility
    - i) The proposed buildings or use shall be constructed, arranged and operated so as to be compatible with the character of the zoning district and immediate vicinity, and shall not interfere with the development and use of adjacent property. The proposed development shall not present an unsightly, obnoxious or offensive appearance to abutting or nearby properties.
  - d) Fencing and Buffering.
    - i) An eight (8) foot tall, opaque fence shall be employed to enclose the storage areas to prevent unauthorized entry and to ensure public safety. A buffer shall be provided around the perimeter of the property, outside the required fence.
  - e) Vehicular Circulation.
    - i) Driveways within the site shall be dust free. Driveway access to the public right-of-way shall be permanently paved and shall be a minimum of twenty-five (25) feet in width.
  - f) Storage Yard Maintenance.
    - i) The lot area surface used for storage shall be gravel, at a minimum.
    - ii) Unusable items that cannot be reused shall be disposed of on a regular basis and shall not be allowed to collect on the premises.
    - iii) All tires not mounted on a vehicle shall be neatly stacked or placed in racks. If stacked, the stacks shall not be stacked over six feet in height.
    - iv) No garbage or other foul smelling waste likely to attract vermin shall be kept on the premises. Gasoline, oil or other hazardous materials that are removed from scrapped vehicles or parts of vehicles kept on the premises shall be disposed of in accordance with applicable federal, state and local regulations.

- g) Nuisance Control.
  - i) Weeds shall be cut or removed before they reach six (6) inches in height. All uses shall comply with the performance standards established for the Industrial, Medium-Density (I2) zoning district.
- h) Buffer.
  - i) No such use shall be established within five-hundred (500) feet of a residential zoning district.
- i) Abandonment.
  - j) The applicant shall provide a written statement that the area will be cleaned up to the satisfaction of the Community Development Director should the salvage yard be abandoned, moved in whole or in part. A salvage yard which remains idle or unused for a continuous period of one year, whether or not fixtures or equipment are removed, shall constitute abandonment. The casual, intermittent, temporary or illegal operation of a salvage yard shall not be sufficient evidence to establish continuous use. If the owner fails to clean up and restore the salvage yard within one year of cessation of operation or abandonment, the Building Official shall have the premises cleaned up and shall use the bond to pay for the costs of cleanup incurred by the City.

#### **Sec. 8.16 – STORAGE/MINI WAREHOUSE FACILITIES**

---

Storage/mini warehouse facilities shall comply with the following requirements:

- 1) Fencing and Screening
  - a) An eight (8) foot tall, opaque masonry fence or wall, located along the front setback line and the side and rear property lines, shall be provided around the perimeter of any storage facility. An opaque fence or wall shall be provided along the setback line abutting a residential district, in addition to a buffer. The fencing shall meet the following requirements:
    - i) Minimum height of the fence or wall shall be six (6) feet.
    - ii) Signs or other advertising mediums shall not be placed upon, attached to, or painted on exterior fences or walls.
- 2) Commercial Activity Prohibited
  - a) The sale of goods or merchandise from or at a storage unit is prohibited.
  - b) Repair of Boats, Vehicles, Motors, or Furniture Prohibited
  - c) The repair, construction, or reconstruction of any boat, engine, motor vehicle, or furniture, and the storage of any propane or gasoline engine or propane or gasoline storage tank is prohibited within any storage unit because of the danger from fire or explosion caused by the accumulation of vapors from gasoline, diesel fuel, paint, paint remover, and other flammable materials.
- 3) Accessibility
  - a) Vehicular ingress-egress shall provide for safe access by customers and emergency vehicles. Access aisles within the site shall be a minimum of twenty (20) feet wide.
- 4) Building Height
  - a) Building height shall not exceed eighteen (18) feet, except that fully enclosed, climate-controlled facilities with units that are accessed from inside the building may be thirty-five (35) feet in height.
- 5) Fire Protection
  - a) Fire hydrants shall be provided to meet the requirements of the fire prevention code adopted by the County.

**Sec. 8.17 – SWAP MEETS AND FLEA MARKETS**

---

- 1) Access
  - a) Swap meets and flea markets shall be accessible from a collector or arterial street, as identified in *Subsection 4.04(2)f(ii)*.
- 2) Buffer Required
  - a) Swap meets and flea markets that are conducted outside shall have a buffer along all property lines abutting residential districts.
- 3) Conduct of Use
  - a) The event shall be conducted entirely on private property, with the approval of the property owner. Any temporary structure used shall be removed upon the cessation of the event.

**Sec. 8.18 – TIRE SALES AND SERVICE**

---

- 1) All tire sales and service centers shall have an accessory building of sufficient size to provide for storage of used tires. Tires shall not be piled in or around main building or create an unsightly appearance in the area.
- 2) Operations involving shredding, cutting or otherwise processing of used or discarded tires, or operations involving the storage, distribution, or sale of used tires or discarded tires if more than two-hundred (200) such tires are located on site, even if such operation is ancillary to the main use of the site. Notwithstanding any other regulations within this article, these uses may only be permitted in I-1 and I-2 zoning districts.

**Sec. 8.19 – VETERINARY CLINIC/ANIMAL CARE FACILITY**

---

- 1) Any structure or area occupied by animals on the premise of the veterinary clinic shall be located at least three-hundred (300) feet from any lot in any residential district except that air-conditioned, soundproofed buildings may be located one-hundred (100) feet from such residential lot or lots.
- 2) For non-sound proofed animal confinements, an external solid fence not less than six (6) feet in height shall be located within fifty (50) feet of the animal confinement and shall be composed of concrete block, brick or other material approved by the Community Development Director. In all cases, animals shall be confined in an enclosed building from 10:00 p.m. to 6:00 a.m.

**Sec. 8.20 – MANUFACTURED HOMES**

---

- 1) Design Standards
  - a) Each manufactured home being constructed, installed, located, or relocated within the city shall comply with the following design standards:
    - i) Roof
      - (1) The pitch of the roof shall have a minimum vertical rise of three feet for each twelve feet (3:12) of horizontal run within tolerances and the roof shall be finished with composition, fiberglass, slate, concrete, asphalt, or wood shingles, or non-reflective, crimped metal sheets.
    - ii) Exterior Siding
      - (1) The exterior siding shall consist of wood, hardboard, brick, masonry.
    - iii) Transport Apparatus
      - (1) The tongue, axles, transporting lights, and towing apparatus from each manufactured home shall be removed after placement or relocation on a lot or parcel and before

- occupancy.
- iv) Landing Area
    - (1) Landings and steps leading away from all exterior doors shall be designed and constructed in accordance with state law, said state law provisions being incorporated by reference as part of this requirement.
  - v) Foundation
    - (1) A masonry foundation or curtain wall, unpierced except for required ventilation and access, and constructed of masonry or acceptable alternative materials shall be constructed and installed in all residential zoning districts. The foundation or curtain wall shall enclose the area located under the manufactured home to the ground level, and shall have a minimum thickness of four (4) inches.
- 2) Age of Manufactured Home
- a) Each conventional and manufactured home being moved, constructed installed, located, or relocated within the city after the effective date of this Code shall not be allowed to locate for permanent or temporary occupancy if such manufactured home is more than seven (7) years old. The age of the manufactured home shall be measured from the day the application for building permit is submitted to the department for approval.
- 3) Dwelling Size
- a) Each conventional and manufactured home being installed, located, or relocated within the city shall contain no less than one-thousand two-hundred thirty (1,230) square feet of living space.

#### **Sec. 8.21 – CREMATORIES**

---

- 1) Location and Screening
- a) A crematory shall not be located within one-thousand (1,000') feet of any residential structure or land zoned for residential purposes. Decorative vinyl fencing or other site-proof fencing or landscaping approved by the City must be located between the crematory and adjacent residential properties.
- 2) Restrictions
- a) Crematories shall not be permitted as an accessory use to an existing Funeral or Mortuary services.
  - b) Crematories shall not emit any odor or particulates.
  - c) Crematories shall have emission stacks covered or shrouded with materials safe for such uses and that are compatible in design and architecture with the surrounding structures.

#### **Sec. 8.22 – SMOKE SHOPS, TOBACCO STORES, AND MEDICAL MARIJUANA DISPENSARIES**

---

- 1) Notwithstanding any other provision of this title to the contrary, smoke shops, tobacco stores, and medical marijuana dispensaries shall be permitted by Special Exception only in the Commercial, Medium-Density (C-2) zoning district.
- 2) Additional zoning and land use standards for smoke shops, tobacco stores, and medical marijuana dispensaries shall be as follows:
- a) Smoke shops, tobacco stores, and medical marijuana dispensaries shall not be located within three-hundred (300) feet, measured property line to property line, from a school (public or private), family day care home, child care facility, youth center, community center, recreational facility, park, church or religious institution, hospital, or other similar uses where children regularly gather.
  - b) Smoke shops, tobacco stores, and medical marijuana dispensaries shall not be located within five-

hundred (500) feet, measured property line to property line, from another smoke shop and tobacco store.

- c) It is unlawful for a smoke shops, tobacco stores, and medical marijuana dispensaries to knowingly allow or permit a minor, not accompanied by his or her parent or legal guardian, to enter or remain within any smoke shops, tobacco stores, and medical marijuana dispensaries.
  - d) Smoke shops, tobacco stores, and medical marijuana dispensaries shall post clear signage stating that minors may not enter the premises unless accompanied by a parent or legal guardian. At least one such sign shall be placed in a conspicuous location near each public entrance to the smoke shop and tobacco store. It shall be unlawful for a smoke shop and tobacco store to fail to display and maintain, or fail to cause to be displayed or maintained, such signage.
- 3) Standard conditions of approval for any Special Exception shall, at minimum, include the following:
- a) No smoking shall be permitted on the premises at any time.
  - b) No sales may be solicited or conducted on the premises by minors.
  - c) No self-service, product, or paraphernalia displays shall be permitted.
  - d) No distribution of free or low-cost products or paraphernalia, as well as coupons for said items, shall be permitted.
- 4) Smoke shops, tobacco stores, and medical marijuana dispensaries that are legally existing on the effective date of the ordinance codified in this chapter may continue to operate as legal nonconforming uses in accordance with *Chapter III: Nonconformities*, and shall not be required to obtain a Special Exception. However, any change or expansion of the legal nonconforming use may require compliance with this chapter and a Special Exception.

**Sec. 8.23 – CULTIVATION OF MEDICAL MARIJUANA**

- 1) This section establishes regulations for the cultivation of medical marijuana for various parcel sizes, residential requirements, setbacks, fencing, civil fines, and other issues to meet this goal. In order to cultivate medical marijuana, the applicant must first obtain permission by the Planning Commission as a Special Exception as outlined in *Section 11.09 – Special Exception Procedure* of this Ordinance. Some of the highlights are listed below:
- 2) A parcel that is greater than 0.5 acres is allowed a maximum cultivation area of 50 square feet.
- 3) Set cultivation limits based on cultivation area, by lot size:

Table 8.5: Cultivation Limits Based on Cultivation Area	
Lot Size (acres)	Cultivation Area
0 - 0.5	Indoor Only**
Greater than 0.5 - Less than 5.0	50 square feet
5.0 - Less than 10.0	100 square feet
10.0 plus	150 square feet
** = (detached structure 120 square feet maximum)	

- 1) Permit cultivation indoors or outdoors on lots greater than 0.5 acre;
- 2) Require minimum recommendations
  - a) Any parcel that is greater than 0.5 acres that is supported by only one recommendation is limited to a cultivation area of up to 50 sq. ft.

- b) A parcel 5.0 acres or more but less than 10.0 acres must have two or more recommendations associated with the plants to support a cultivation area of up to 100 sq. ft.
- c) A parcel 10.0 acres or more must have three or more recommendations associated with the plants to support a cultivation area of up to 150 sq. ft.
- 3) Require a single cultivation area, length and width of the cultivation area shall not exceed a ratio of 2:1;

<b>Lot Size (acres)</b>	<b>Setback (feet)</b>
0 - 0.5	15
Greater than 0.5 - Less than 5.0	50
5.0 - Less than 10.0	75
10.0 plus	150

- 4) Require cultivation and harvesting setbacks from property lines (with exceptions for unusual hardships):
- 5) Provide that any person may make a complaint relating to violations (anonymous complaints will be accepted);
- 6) Require that growers reside in Dallas for one year prior to cultivating;
- 7) Require growers have a permitted permanent water well or connection to municipal water, not engage in unpermitted drawing of water and not permit illegal discharges of water;
- 8) Prohibit cultivation:
  - a) within 1,000 feet of a school, park or similar facility;
  - b) within 600 feet of a school bus stop;
  - c) within 100 feet of an occupied residential structure on an adjacent parcel, with exceptions;
  - d) in any location where plants are visible from a public right of way; and
  - e) in certain designated zones.
- 9) Require growers to obtain landlord's written consent to cultivate;
- 10) Require fencing unless grown on 5 acres or more and not in public view;
- 11) Impose Administrative Civil Penalties have been increased to \$500.00 a day for the first three days (72-hours) and \$1,000.00 a day for each day the violation still exists up to a hearing.

**Sec. 8.24 – TRANSFER STATIONS, SOLID WASTE COLLECTION FACILITY**

- 1) In General
  - a) An applicant proposing to establish a transfer station or solid waste disposal facility, as defined in *Chapter XIII - Definitions*, shall be required to obtain a Special Exception, in conformance with *Sec. 11.09 – Special Exception Procedure* of this Code.
- 2) Permitted Locations
  - a) A transfer station or solid waste collection facility may be permitted with a Special Exception in the I-2 zoning district. The establishment and operation of any transfer station or solid waste disposal facility must comply with any and all standards and provisions provided by the Environmental Protection Division of the State of Georgia and subject to the standards of the zoning district and the supplemental standards of this Section.

## 3) Guarantee Required

The applicant shall post and maintain a guarantee with the City Clerk. This guarantee, approved in form by the City attorney, will assure the City that the applicant shall complete the plan for restoration for reuse, within one (1) year of discontinuance of the transfer station or solid waste collection facility. The amount of the guarantee shall be not less than the estimated cost of the restoration, and the amount of the estimate shall be approved by the Community Development Director. If the restoration is not completed within the specified time, the City may use the bond or any portion thereof to complete the restoration. Failure to maintain a guarantee shall be grounds for revocation of the Special Exception authorizing the use.

## 4) General Standards

a) Any applicant for a transfer station or solid waste collection facility operating permit shall demonstrate compliance with the following site limitation provisions:

## i) Building

(1) All on-site processing and transferring of solid waste will be conducted entirely within an enclosed building or buildings.

(a) An enclosed building for these purposes is one in which the walls, doors and roof are made of solid materials but may contain accessory structural elements such as windows, properly filtered and controlled ventilation openings, and skylights, each element not exceeding an area of 100 square feet.

(b) Doors to any building shall remain closed except to temporarily allow transport vehicles to enter and exit the building.

(c) All solid waste transfer stations and processing facilities shall have an operator in attendance at all times when the facility is in operation.

## 5) Performance Standards

## a) Minimum Lot Size

i) The minimum lot area for a solid waste transfer station and collection facility shall be ten (10) acres.

## b) Setbacks

i) A transfer station or solid waste collection facility must meet the Development Standards of *Section 4.17 –Industrial, Medium-Density (I-2)*, and shall be located an additional fifty (50) feet of those standards.

## c) Compatibility

i) The proposed building(s) or use shall be constructed, arranged and operated so as to be compatible with the character of the zoning district and immediate vicinity, and shall not interfere with the development and use of adjacent property. The proposed development shall not present an unsightly, obnoxious or offensive appearance to abutting or nearby properties.

## d) Location

i) No such use shall be established within three-hundred (300) feet of a residential zoning district, measured from property line to property line. Where a lot containing a solid waste transfer station or processing facility is within five-hundred (500) feet of any residential property, the facility may not accept waste on Sunday, or earlier than 7:00 a.m. or later than 6:00 p.m. on any other day.

## e) Fencing

i) All transfer station or solid waste collection facilities shall be enclosed with a fence not less than eight (8) feet tall and no more than ten (10) feet tall, with openings therein not less than those in two-inch mesh wire or some other similar fencing material or device. The fencing shall

- be adequate to prevent paper and similar or related refuse or waste from blowing from the facility onto neighboring or nearby property.
- f) Buffering
    - i) A vegetative buffer must be provided between transfer station or solid waste collection facility and any abutting real property line or public street right-of-way.
      - (1) Existing trees and vegetation must be maintained and preserved within fifty (50) feet of any around the perimeter of the property, outside the required fence and any public street or right-of-way.
      - (2) Where any portion of any property line of a lot containing a solid waste transfer station or handling facility is within two-hundred and fifty (250) feet of any residential property, any existing trees and vegetation must be maintained and preserved within fifty (50) feet of the real property line.
      - (3) Where the natural growth within the proscribed distance of the abutting real property line or public right-of-way does not effectively screen the site from the view from abutting properties or right-of-way, then screening shall be provided, subject to the approval of the City Council or their designee.
      - (4) Vehicular Circulation and Access
    - ii) Driveways within the site shall be dust free. Driveway access to the public right-of-way shall be permanently paved and shall be a minimum of twenty-five (25) feet in width. Access is prohibited through residentially zoned areas.
  - g) Storage Yard Maintenance
    - i) The lot area surface used for storage shall be gravel, at a minimum.
    - ii) Unusable items that cannot be reused shall be disposed of on a regular basis and shall not be allowed to collect on the premises.
  - h) Nuisance Control
    - i) The developer shall install an automatic spray system to control odor and practice a hand held spray regimen to control the potential odors that may settle into the environment.
    - ii) The developer shall practice adequate measures to control litter and blowing debris from the transfer station.
    - iii) The developer shall practice adequate measures to maintain pest control throughout the facility.
  - i) Landscaping
    - i) Landscaping shall be provided as required under the *Section 7.05 – Landscape Standards*. The use of landscaping shall be required on the entire property to improve the appearance of setback and yard areas and to preserve the character and value of surrounding properties.
  - j) Utilities
    - i) Transfer station or solid waste disposal and processing facilities must be served by public water and sewer facilities.
  - k) Abandonment
    - i) The applicant shall provide a written statement that the area will be cleaned up to the satisfaction of the Community Development Director should the transfer station or solid waste disposal be abandoned, moved in whole or in part. A solid waste disposal and processing facility which remains idle or unused for a continuous period of one year, whether or not fixtures or equipment are removed, shall constitute abandonment. The casual, intermittent, temporary or illegal operation of a transfer station shall not be sufficient evidence to establish continuous

use. If the owner fails to clean up and restore the transfer station within one year of cessation of operation or abandonment, the Building Official shall have the premises cleaned up and shall use the bond to pay for the costs of cleanup incurred by the City.

### Sec. 8.25 – RESTRICTIONS ON THE KEEPING OF FARM ANIMALS AND BEES

---

- 1) **PURPOSE.** The regulations of this section are established to permit the keeping of farm animals and bees in a manner that prevents nuisances to occupants of nearby properties and prevents conditions that are unsanitary or unsafe.
- 2) **CHICKENS, DUCKS, RABBITS AND SIMILAR ANIMALS.** The keeping of chickens, ducks, rabbits and similar farm animals, and cages, coops and enclosures for the keeping of such animals, shall be governed by the following regulations.
  - a) In Residential Districts. In Residential Districts, the following regulations shall apply.
    - i) **Number.** No more than one such animal shall be kept on a parcel of land for each eight-hundred (800) square feet of parcel or lot area. For a standard residential lot of eighty-five hundred (8,500) square feet, this regulation would permit no more than a total of ten (10) such animals.
    - ii) **Setbacks.** The coops or cages housing such animals may not be located in front yard or side street yard areas and shall not be located within ten (10) feet of a side or rear yard line, except where the rear lot line forms the side lot line or front lot line of an abutting property, in which case the setback from such rear lot line shall be five (5) feet. Chicken coops shall not be closer than twenty-five feet from the primary structure of any adjacent lot, and shall not be located closer than fifteen (15) feet from the primary structure on the same lot. There shall be no separation requirements between accessory structures on the same lot, so long as all other zoning requirements are satisfied. No animals shall be kept in required front yard or side street yard areas.
    - iii) **Prohibitions.** No roosters, geese or turkeys may be kept in a Residential District except on a parcel that is at least one (1) acre in area and only if the coop or cage housing the bird(s) is at least one-hundred (100) feet from all property lines. For parcels greater than one (1) acre in area, one (1) additional such bird may be kept for each twenty-four thousand (24,000) square feet in excess of one (1) acre. No predatory birds may be kept on any property under the regulations of this Section.
    - iv) **Coops and Cages.** All animals shall be provided with a covered, predator-proof coop or cage or other shelter that is thoroughly ventilated, designed to be easily accessed and cleaned, and of sufficient size to permit free movement of the animals, exclusive of areas used for storage of materials or vehicles. The total area of all coops or cages on a lot shall not be greater than thirty-two (32) square feet for up to six (6) animals. Coops and cages, singly or in combination, shall not exceed fifteen (15) feet in height.
    - v) **Enclosures and Fences.** Chickens and other birds shall have access to an outdoor enclosure adequately fenced or otherwise bounded to contain the birds on the property and to prevent access by dogs and other predators and providing at least ten (10) square feet of area for each bird.
  - b) In Non-Residential Districts. In zoning districts other than Residential Districts, all regulations applicable in Residential Districts shall apply except that the number of such animals shall be limited to one (1) animal for each four-hundred (400) square feet of lot area.

Figure 8.2: Urban Chicken Setback Minimums (not to scale)

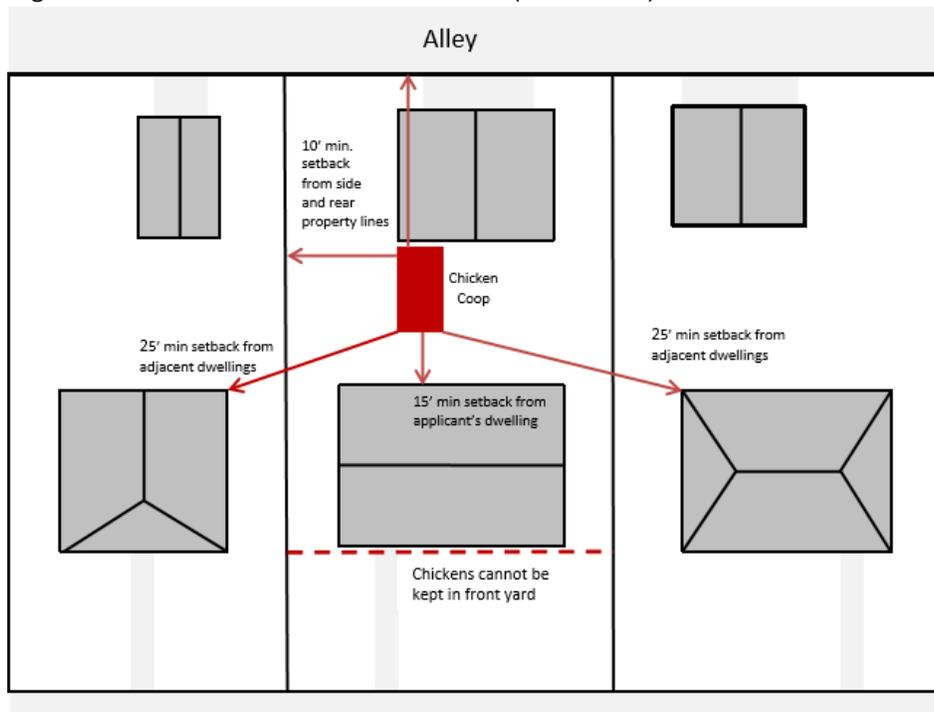

- 3) GOATS, PIGS, SHEEP AND SIMILAR ANIMALS. The keeping of goats, pigs, horses, sheep, cows, alpacas, llamas, or similar farm animals, and stables and enclosures for the keeping of such animals, shall be prohibited.
  - a) Exceptions. Animals used for clearance of vegetation shall be allowed for no more than fourteen (14) consecutive days.
- 4) BEES. The keeping of bees, and associated beehives, shall be governed by the following regulations.
  - a) In Residential Districts. In Residential Districts, the following regulations shall apply
    - i) Number. No more than one (1) beehive shall be kept for each twenty-five hundred (2,500) square feet of lot area, and no beehive shall be kept on a lot less than twenty-five hundred (2,500) square feet in area.
    - ii) Location and Setbacks. No beehive shall be kept closer than five (5) feet to any lot line and ten (10) feet to a dwelling or the permitted placement of a dwelling on another parcel, and no beehive shall be kept in a required front yard or side street yard. The front of any beehive shall face away from the property line of the Residential property closest to the beehive.
    - iii) Fences and Shrubs. A solid fence or dense hedge, known as a "flyway barrier," at least six (6) feet in height, shall be placed along the side of the beehive that contains the entrance to the hive, and shall be located within five (5) feet of the hive and shall extend at least two (2) feet on either side of the hive. No such flyway barrier shall be required if all beehives are located at least twenty (20) feet from all property lines and for beehives that are located on porches or balconies at least ten (10) feet above grade, except if such porch or balcony is located less than five (5) feet from a property line.
    - iv) Water Supply. A supply of fresh water shall be maintained in a location readily accessible to all bee colonies on the site throughout the day to prevent bees from congregating at neighboring swimming pools or other sources of water on nearby properties.

- v) Prohibitions. No Africanized bees may be kept on a property under the regulations of this Section.
- b) In Non-Residential Districts. In zoning districts other than Residential Districts, all regulations applicable in Residential Districts shall apply except that the number of beehives shall be limited to one (1) for each one-thousand (1,000) square feet of lot area.

Figure 8.3: Bee Hive Site Layout Example

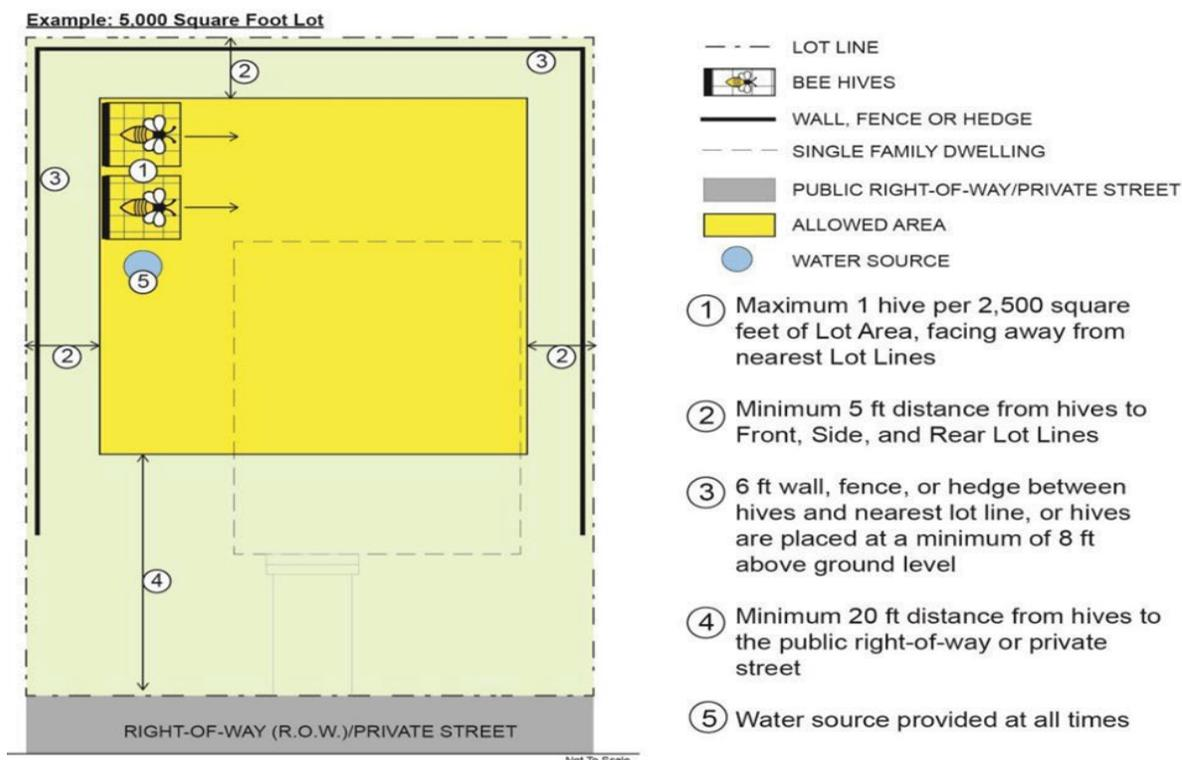

- 5) LOTS WITHOUT A RESIDENCE. Notwithstanding the provisions of *Section 8.02– Accessory Use and Structure Standards*, farm animals or bees may be kept on a lot that is vacant or has no occupied residence but only if the applicant for such activity submits written this Section, demonstrating that the use will be managed in a manner that prevents the creation of nuisances or unsanitary or unsafe conditions.
- 6) SANITATION AND NUISANCES. Farm animals shall be kept only in conditions that limit odors and noise and the attraction of insects and rodents so as not to cause a nuisance to occupants of nearby buildings or properties and not to cause health hazards. Furthermore, farm animals shall not be kept in a manner that is injurious or unhealthful to the animals being kept on the property.
- 7) ANIMAL OR BIRD NOISE. It shall be unlawful for any person or other party operating or occupying any building or premises to keep or allow to be kept any animal or bird that makes noise so as to habitually disturb the peace and quiet of any person in the vicinity of the premises.
- 8) SLAUGHTERING OF ANIMALS. Chickens, ducks, rabbits and similar small animals may be slaughtered on site only inside a garage or other building and only if for use by the occupants of the premises and not for sale. No other farm animal may be slaughtered on site.
- 9) regulations regarding construction and permitted placement of enclosures, fences, cages, coops, beehives, flyway barriers, stables and other structures used in the keeping of farm animals or bees and

whether the property is occupied by a condemned building.

- a) Application Contents. The application for such license shall include, at a minimum, the following information.
    - i) The name, phone, phone number and address of the applicant;
    - ii) The location of the subject property;
    - iii) The size of the property;
    - iv) The number of animals or bee hives to be kept on the property;
    - v) A description of any proposed cages, coops, beehives, fences or enclosures;
    - vi) A scaled drawing showing the precise location and setbacks of cages, coops, enclosures, beehives, stables and fences in relation to property lines and to houses on adjacent properties;
    - vii) A description of the manner by which feces and other waste materials will be removed from the property or will be treated so as not to result in unsanitary conditions or in the attraction of insects or rodents;
    - viii) In the case of a lot that is vacant or has no occupied residence, documentation demonstrating that the use will be managed in a manner that prevents the creation of nuisances or unsanitary or unsafe conditions;
    - ix) A signed statement from the property owner, if the applicant is not the property owner, granting the applicant permission to engage in the keeping of farm animals or bees as described in the registration; and
    - x) The addresses of all properties directly adjoining the subject property.
  - b) License Approval. The Director of Community Development shall take action on a license application for the keeping of farm animals or bees in accordance with the following provisions:
    - i) Approval Standards. In evaluating an application for an initial license or a license renewal, the Community Development Director shall consider any evidence ascertained through inspections of the property or through the submission of evidence regarding nuisances or conditions that are unsafe or unsanitary relative to the subject property and, in particular, any recorded violations. The Director of Community Development may deny a license on consideration of such evidence.
    - ii) Community Development Approval. The Community Development Director shall not approve any initial license application for the keeping of farm animals or bees prior to approval of the site plan by the Department of Community Development in accordance with the provisions of *Section 8.25 – Restrictions on the Keeping of Farm Animals and Bees* of the Zoning Code.
  - c) Building Permits. A Building Permit shall be required for installation of a fence or for construction of a stable or other structure routinely requiring such permit, except that no Building Permit shall be required for cages, coops or beehives that are not permanently attached to the ground or to another structure and do not exceed thirty-two (32) square feet in area nor eight (8) feet in height. No Building Permit shall be required for the barrier constituting a required enclosure if such barrier is not permanently attached to the ground and does not exceed three (3) feet in height; and no Permit shall be required for a "flyway" barrier not exceeding six (6) feet in height and six (6) feet in length.
- 10) **LICENSE EXPIRATION**. Such license shall expire at the end of a calendar year and shall be renewed once every two (2) years during November or December before the end of the calendar year. The application

for renewal of a license need not include drawings and other information regarding conditions that have not changed since submission of such information in a prior license application.

- 11) LOTS WITHOUT A RESIDENCE. In the case of an application to keep farm animals or bees on a lot that is vacant or has no occupied residence, a License shall be granted only if the applicant submits written documentation satisfactory to the Community Development Director demonstrating that the use will be managed in a manner that prevents the creation of nuisances or unsanitary or unsafe conditions. Where the applicant is not the property owner, a license shall be granted only where the application is accompanied by a signed statement from the property owner granting the applicant permission to engage in the keeping of farm animals or bees.
- 12) ENFORCEMENT. The Director of the Department of Community Development or any authorized City employee shall have the authority to inspect any property to determine compliance with the regulations of *Section 8.25* of the Zoning Code regarding sanitation and nuisances and operational practices in the keeping of farm animals or bees and shall have the authority to enforce the regulations of this Section.
- 13) PENALTIES. If the Director of Community Development determines that an individual is in violation of the provisions of this section or *Section 8.25 – Restrictions on the Keeping of Farm Animals and Bees* with respect to the enforcement responsibilities of the Department of Community Development, the Director shall issue a violation notice to the individual, noting the nature of the violation(s). If the violation is not corrected within seven (7) days of issuance of the violation notice, the recipient of the notice shall be subject to the following penalties and enforcement actions.
  - a) For a first offense, a fine of fifty dollars (\$50.00);
  - b) For a second offense occurring within four (4) months of the first offense, a fine of seventy- five dollars (\$75.00);
  - c) For a third and any subsequent offense occurring within the period of the current two (2) year license, any farm animals or bee hives associated with the violation shall be removed from the property by the individual or shall be removed and impounded.

#### **Sec. 8.26 – FILM PRODUCTION**

---

- 1) PERMISSIBLE DISTRICTS. All Districts
- 2) STANDARDS
  - a) Application.
    - i) Applicant must request permission to use City property including but not limited to, parks, streets, alleys, sidewalks, or buildings owned by the City, for a film production prior to submission of the application.
    - ii) Rush approvals (permits requested within less than fourteen (14) days of production) will be assessed due to increased demand for staff time and coordination. The application shall include, but not be limited to, the following:
      - (1) The filming project name;
      - (2) The name and contact information of the applicant, including postal address, email address, and telephone number;
      - (3) A valid photo identification of the applicant;
      - (4) The name and contact information of the producer (if the applicant is not the producer);
      - (5) The dates, times and locations of the filming for which permit is being requested, and a general description of the filming activity that will occur at each location;

- (6) Where the producer is a student, an official letter or document from his/her school confirming that s/he is currently enrolled there. In addition, the student identification card and a valid driver's license. Where the student does not have a driver's license, s/he may present a different form of identification that includes his/her photo.
- b) Public Works/Public Safety.
- i) If roads are to be blocked or traffic disrupted in any manner, off-duty City of Dallas police officers must be hired and compensated at a minimum of three hours per day. (Note: Closure of State roads requires a 45-day lead time and approval from the Georgia Department of Transportation.)
  - ii) Removal, cutting or trimming of vegetation in the public right-of-way is prohibited unless specifically approved by the permit.
  - iii) No film activity which involves the use of explosives, pyrotechnics, fire, smoke-making machines or other special effects may be undertaken unless specifically approved by the Paulding County Fire Department.
  - iv) Tents or temporary membrane structures having an area in excess of five-thousand (5,000) square feet require an inspection by the County Fire Marshall of the county.
  - v) Emergency vehicle access shall be maintained at all times. EMS personnel are required on-site for productions with stunts being performed.
  - vi) The County Fire Marshall shall have full access to any film production to ensure safety for crew members, the public, and surrounding properties.
- c) Permit Issuance.
- i. If permission is granted by the City, a written permit will be issued including time, date and location of filming and acceptable activities within the scope of the permit.
  - ii. A producer and/or applicant that receives a permit is responsible for knowing and complying with this ordinance and all other laws, including other ordinances and regulations that establish prerequisites, authorizations and other required permissions applicable to the filming.
  - iii. Upon receipt of the permit, the production company must provide a certificate of insurance naming the City of Dallas as an additional insured. The City requires an insurance policy rider for general liability and worker's compensation for one-million dollars (\$1,000,000) each occurrence and aggregate with endorsement naming the City of Dallas as additional insured.
  - iv. Upon receipt of the permit, the production company must notify affected businesses and property owners within five-hundred (500) feet of production. Compensation may be necessary if business and home environments are greatly disrupted.
  - v. The City shall require the production company to have the permit on site at all times.
  - vi. Notwithstanding any other part of this Code, any producer that performs filming without receiving a permit, violates the material terms of a permit, or is otherwise in violation of this Ordinance, shall be subject to the provisions of *Chapter XII: Violations and Enforcement* of this ordinance.
- b. Film Production Wrap-Up. Upon completion of work, all materials and debris shall be entirely removed and the right-of-way left in the same condition it was in immediately prior to filming. Any costs for clean-up by the City will be charged to the permit holder who will be invoiced by the City for such costs. Invoices for such costs must be paid in full within thirty (30) days from the date of issuance by the City.
- c. Advertising

- i. The City of Dallas logo its buildings or the name of the City may not be included in the film or its marketing and advertising without written permission.
  - ii. Where permitted filming includes advertising signs or other displays of commercial speech, the signs and/or displays must be removed upon the expiration of the permit.
- b) Indemnification.
- i) The producer must sign an indemnification provision on the permit whereby the producer agrees to indemnify the City and its officials and employees from all claims, losses and expenses, including attorneys' fees and costs, that may arise from the permit and any of the activities performed pursuant to the permit by, on behalf of, or at the direction of the producer, except to the extent that claims, losses and/or expenses are caused by the gross negligence or intentional misconduct of the City, its officials and or employees.
- c) Exception.
- i) A permit shall not be required for filming on private property or for the filming of public events such as rallies, protests, demonstrations, or other events held on City property and open to the public at large.

### Sec. 8.27 – LIQUOR STORES, PACKAGE STORES, AND LIQUOR OUTLETS

---

- 1) Package Stores are restricted to the C-1 Commercial Low Density, and C-2 Commercial Medium-Density zoning districts. In addition to being zoned C-1 or C-2, there are additional zoning requirements as follows:
  - a) The property must have a least two-hundred (200) feet of road frontage on a state highway or major arterial, be at least one (1) acre in size, and must be used exclusively for the purpose of selling distilled spirits. This means that a package store shall not be part of a shopping center. It must be a stand-alone building.
  - b) Any building constructed on the property shall be:
    - i) be at least six-thousand (6,000) square feet – of which at least seventy-five (75%) percent shall be dedicated to public retail sales;
    - ii) shall be occupied by a single tenant;
    - iii) shall have one entrance and one exit and these shall be located at the front of the building;
    - iv) shall have at least one hundred-fifty (150) square feet of plate glass (this excludes plate glass used in the door);
    - v) shall have no windows or doors on the sides or rear of the building. Drive-in establishments are permitted subject to the provisions of Section 8.09.
    - vi) shall not have living quarters or residential space on the premises.

### Sec. 8.28 – SHIPPING CONTAINERS

---

- 1) Shipping containers shall be considered primary structures under the terms of this ordinance and follow all regulation and restrictions specified herein.
  - a) Shipping containers are required to have foundations for footings. All Shipping containers must be located on a structural foundation and have appropriate footings.
- 2) Shipping containers are only permitted in the CBD, MXU, C-2 and I-2 zoning districts as Special Exception Uses, requiring annual renewal by the Community Development Director.
  - a) Shipping Containers located in commercial zoning districts may only be used for retail, bar/tavern or restaurant uses. Shipping containers shall not be used as ancillary storage or for other non-customer facing functions.
  - b) The containers shall not be used for residential purposes.
- 3) GENERAL TEMPORARY USE AND STRUCTURE STANDARDS APPLICABLE TO ALL ZONING DISTRICTS.

Temporary Structure Standards. Shipping Containers that are used for temporary occupancy or to be used in conjunction with two or more containers as a cooperative commercial or industrial space shall meet all requirements within this section.

- a) All temporary structures shall conform to the following requirements:
  - i) Applicable Development Standards. Temporary structures must meet all development standards for a permanent accessory structure unless otherwise specified in this section.
  - ii) Temporary Structure Time Limits. Any temporary structure used for a permitted primary use may be permitted for up to two (2) years, unless otherwise specified by this ordinance.
  - iii) All temporary uses shall occur outside of the right-of-way.
- b) Temporary Use and Structure Standards. Temporary uses and structures are permitted in any zoning district provided that the use is a permitted use in that zoning district.
  - i) Permit Requirements. All temporary uses and structures shall require a permit unless otherwise specified in this section. No temporary use or structure, or the related signs, lighting, parking, etc., shall be constructed or placed upon a site prior to all necessary permits being obtained.
  - ii) Time Limits. Temporary uses and/or structures that seek extensions of the initial time limits established in this section shall be subject to administrative approval.
    - 1) One (1) year extensions may be granted by the Director who may impose reasonable conditions as part of the approval. A bi-annual renewal of the Temporary Structure Permit by the Community Development Director is required.
  - iii) Removal. All temporary uses and/or structures must be removed and the site reverted to its original condition within the duration of the permit or any extension thereof.
- 4) DIMENSIONS. Shipping containers may not be more than the standard high cab dimensions (40 feet wide and no more than 8 feet in depth). Rooftop patios and steps leading to the roof of the container are permitted and may exceed the height restrictions stated, but require review and approval from the authority having jurisdiction.
- 5) QUANTITY. No more than four containers are permissible on a lot at one time. Should additional containers be desired, a site plan shall be prepared and approved by the City Council prior to the colocation of more than one container on a single site. Shipping containers may be stacked vertically, however the peak height shall not exceed 24' from finished elevation of the main level shipping container. No more than two (2) shipping containers may be stacked vertically on any given lot.
- 6) LOCATION. The containers are permitted no closer than 5 feet to the front, side and rear property lines. All shipping containers shall be at least 5 feet from another structure, including other shipping containers.
  - a) All containers shall be located on a hard, dustless surface. Each container project used for commercial purposes is required to have an exterior patio that serves as additional public space.
- 7) Architectural Standards
  - a) All shipping containers used for commercial purposes shall be painted an attractive design.
  - b) The use of awnings, canopies and porte-cocheres are encouraged and shall contribute to the overall design aesthetic.
  - c) Exterior façade walls shall be clad in metal, finished wood, cementitious siding, or a combination of.
  - d) If shipping containers are used as accessory structures to a primary structure on site, they must be architecturally compatible and similar to the principle structure.
    - i) A covered walkway or breezeway is allowed between a primary structure and accessory structure. Such connection shall not be exempt the accessory structure from compliance

with the standards of this section.

- e) The name of the business shall be clearly identified via signage on the primary façade of the container.
- f) The use of Shipping Containers as stated in this section will be exempt from the design standards of Sec. 9.04.
- g) All proposed uses of shipping containers must be presented to the Community Development Director through the use of renderings and floor plans and approved in order to proceed.

### Sec. 8.29 – ROOFTOP DECKS/TERRACES

- 1) Roof decks are permitted for residential uses in all zoning districts. Roof decks for non-residential uses are prohibited, except in the CBD and MXU district, where special exception approval in accordance with the procedures is required. Roof decks are prohibited on accessory structures.
- 2) Setbacks. Roof decks must be set back at least five (5) feet from the extreme front building line. In cases where the top story is already set back at least five ft. from the front building line of the building, the roof deck does not require an additional setback. A roof deck may not be constructed in the front setback.

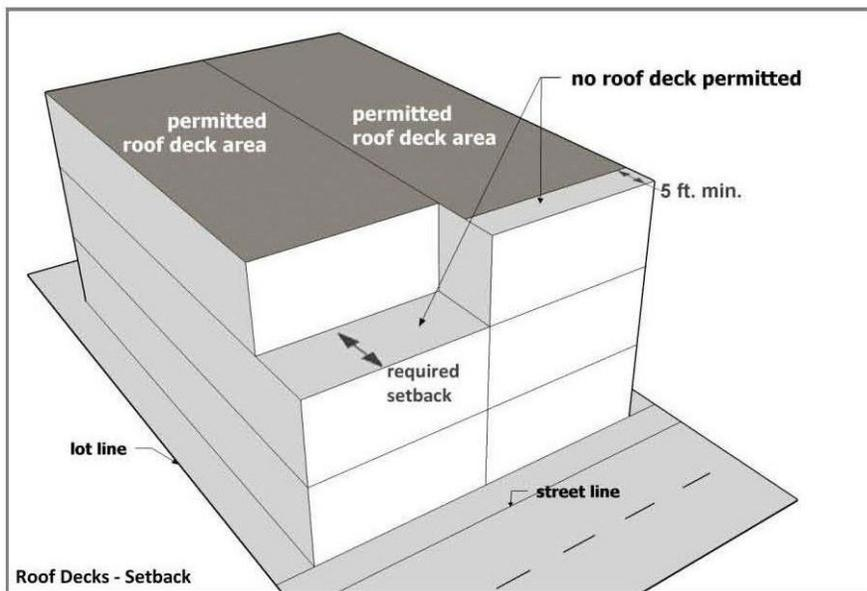

- 3) Height. A roof deck and associated railings and fencing is considered a permitted appurtenance and is not subject to the building height limitations of the subject zoning district, provided that no part of the deck surface extends more than 48 in. above a plane that is midway between the lowest and the highest points of the roof surface supporting the rooftop deck.
- 4) Roof Deck Access Structures. A roof deck access structure meeting the following requirements is considered a building appurtenance and is not subject to the building height limitations of the subject zoning district.
  - 1) The roof deck access structure may only serve to enclose the access stairs, elevators, or other means of access.
  - 2) The roof deck access structure may not exceed 125 sq. ft. in area, however roof deck access structures that also contain an elevator are permitted an additional 40 sq. ft. of area.
  - 3) The roof deck access structure may not exceed 10 ft. in height above the surface of the roof deck.
- 5) Roof deck access structures must meet the same setback requirements as the associated roof deck, provided that any part of the roof deck access structure located more than 42 in. above the surface of the roof deck must be set back an additional 5 ft. from the required setback of the associated roof deck. The roof deck access structure must be set back 5 ft. from the rear building line.

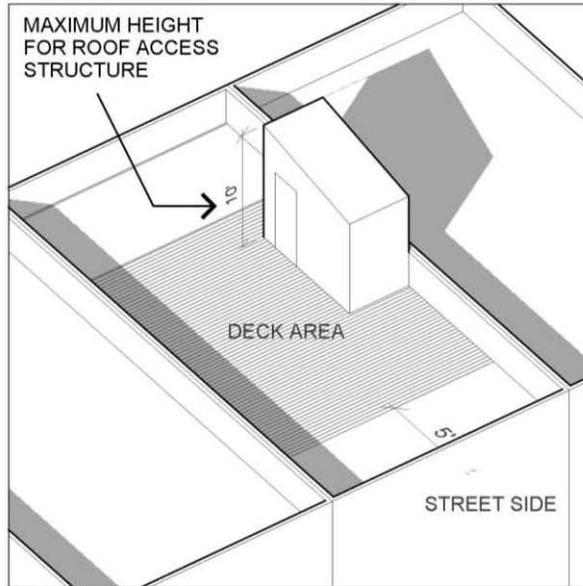

Roof Decks - Access Structures

- 6) For illustrative purposes only, the following diagrams show the permissible area for a roof deck access structure:

**Permitted Roof Deck Access Structure Area, Attached Dwelling:**

PERMITTED PILOT HOUSE AREA\*

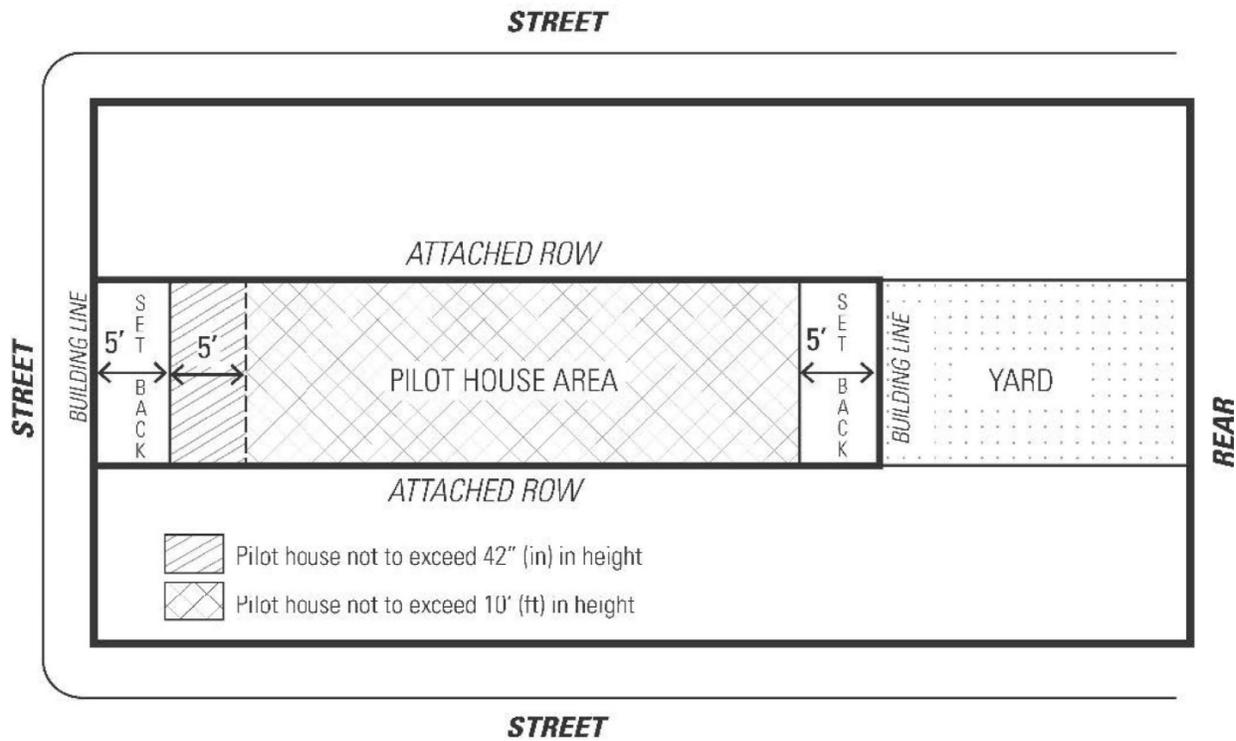

\*Pilot house not to exceed 10'(ft) in height or 125 sq. ft in area (165 sq. ft. with elevator)

Note: Height limitation applies everywhere.

**Permitted Roof Deck Access Structure Area, Corner Lot:**

**PERMITTED PILOT HOUSE AREA\***

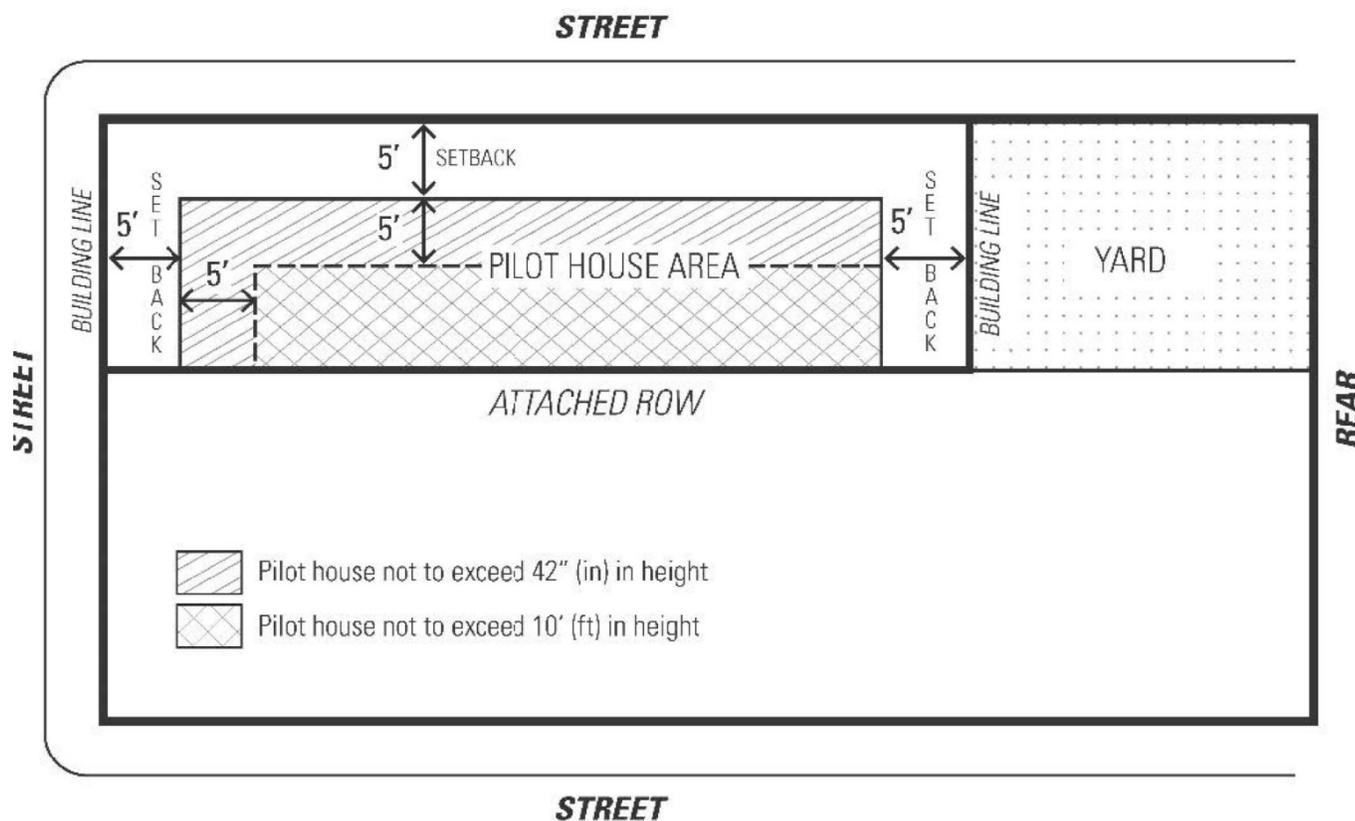

\*Pilot house not to exceed 10'(ft) in height or 125 sq. ft in area (165 sq. ft. with elevator)

Note: Height limitation applies everywhere.

- 7) Fences, Guard Rails, and Privacy Screens. Fences or guard rails used to enclose roof decks may not exceed 42 in. in height, except that privacy screens up to 60 in. in height and no more than fifty percent (50%) opaque may be installed on the sides of the roof decks that are parallel to side lot lines and located within 18 in. of a side lot line that is not also a street line.

**Sec. 8.30 – ELECTRIC VEHICLE CHARGING STATIONS**

- 1) Purpose. To provide standards relating to electric vehicle infrastructure and to guide the development of electric vehicle infrastructure in order to protect the public health, safety, and welfare and avoid significant impacts on resources and adjacent uses. By enacting this ordinance, it is the intent of the City of Dallas to:
  - a) Respond to and/or prepare for the increased need for electric vehicle infrastructure resulting from increased ownership and usage of electric vehicles;
  - b) Encourage the establishment of convenient, cost-effective electric vehicle infrastructure that such use necessitates.
  - c) Encourage the location of electric vehicle infrastructure, to the extent possible, in areas where any

- potential adverse impacts on the community will be minimized;
- 2) Applicability.
    - a) This ordinance shall apply to all electric vehicle infrastructure installed, constructed or modified after the effective date of this ordinance.
    - b) Electric vehicle infrastructure in place prior to this effective date of this ordinance shall not be required to meet the requirements of this ordinance, unless substantial modification to the infrastructure is proposed.
    - c) All electric vehicle infrastructure shall be designed, built and installed in accordance with applicable local, state and federal codes, regulations and standards.
  - 3) Requirements for Electric Vehicle Infrastructure.
    - a) Permitted Locations
      - i) Level-1 and Level-2 electric vehicle charging stations are permitted in every zoning district, when accessory to the primary permitted use. Such stations located at one-family, multiple-family, and mobile home park dwellings shall be designated as private restricted use only. Installation shall be subject to permit approval administered by the Community Development Department.
      - ii) Level-3 electric vehicle charging stations are permitted in the CBD, MXU, and C-2 districts, when accessory to the primary permitted use. Installation shall be subject to permit approval administered by the Community Development Department.
      - iii) If the primary use of the parcel is the retail electric charging of vehicles, then the use shall be considered a gasoline service station for zoning purposes. Installation shall be subject to Special Exception approval and located in zoning districts which permit gasoline service stations.
  - 4) Application and Approval
    - a) Charging stations located at one-family, multi-family, and mobile home park dwellings as accessory uses shall comply with the requirements of this ordinance and any applicable permitting requirements.
    - b) Charging stations located at commercial sites and as accessory uses shall comply with site review and permitting requirements.
    - c) Charging stations located at commercial sites and as primary uses shall be subject to Special Exception approval and located in zoning districts which permit gasoline service stations (filling stations). Site review and permitting requirements shall also apply.
  - 5) General Requirements for Residential and Non-Residential Development
    - a) Electric vehicle charging stations within single family residences are exempt from the below general requirements. This does not exempt electrical or other permit obligations.
    - b) Parking.
      - i) An electric vehicle charging station space may be included in the calculation for minimum required parking spaces required in accordance with Section 7.02 *Off-Street Parking and Loading*.
      - ii) Public electric vehicle charging stations are reserved for parking and charging electric vehicles only. Electric vehicles may be parked in any space designed for public parking, subject to the restrictions that would apply to any other vehicle that would park in that space.
    - c) Accessible Spaces. A minimum of one accessible electric vehicle charging station is required in any parking facility that is required to have one electric vehicle parking space. For parking facilities to have 51-75 electric vehicle parking spaces the number of accessible spaces will increase to two (2). Between 76-100 electric vehicle parking spaces increases to three (3) and each thereafter increment of 25 electric charging station shall increase by one additional accessible electric vehicle charging space. Accessible electric vehicle charging stations should be located in close proximity to the building or facility entrance and connected to a barrier-free accessible route of travel. It is not necessary to designate the accessible electric vehicle charging station exclusively for the use of disabled persons.
    - d) Required For Certain Uses. Electric vehicle charging spaces are required to be installed at all multi-

- family developments, commercial properties with more than 100 parking spaces, and filling stations.
- i) Multifamily developments shall provide electric vehicle charging station infrastructure (wiring, conduit, etc.) at a rate of 20% of all parking spaces. A minimum of one charging station is required per fifty (50) parking spaces.
  - ii) Commercial properties shall provide electric vehicle parking spaces at a rate of at least one (1) space per seventy (50) parking spaces.
  - iii) Filling stations shall provide electric vehicle charging stations at a rate of at least one (1) charging station per ten (10) gasoline pumps approved after the passage of this chapter.
- b) Location and Design.
- i) Lighting. Site lighting shall be provided where an electric vehicle charging station is installed, unless charging is for daytime purposes only.
  - ii) Size. The minimum width for a parking space for charging electric vehicles is nine (9) feet.
- c) Equipment Standards and Protection.
- i) Battery charging station outlets and connector devices shall be no less than 36 inches and no higher than 48 inches from the surface where mounted. Equipment mounted on pedestals, lighting posts, bollards, or other devices shall be designed and located as to not impede pedestrian travel or create trip hazards on sidewalks.
  - ii) Adequate battery charging station protection, such as concrete-filled steel bollards, shall be used. Curbing may be used in lieu of bollards, if the battery charging station is setback a minimum of 24 inches from the face of the curb.
- d) Usage Fees. The property owner or operator is not restricted from collecting a service fee for the use of an electric vehicle charging station made available to visitors of the property.
- e) Signage.
- i) Information shall be posted identifying voltage and average levels and any time of use, fees, or safety information related to the electric vehicle charging station.
  - ii) Each electric vehicle charging station space shall be posted with signage indicating the space is only for electric vehicle charging purposes. For purposes of this subsection, “charging” means that any electric vehicle is parked at an electric vehicle charging station and is connected to the battery charging station equipment. Restrictions shall be included on the signage, if removal provisions are to be enforced by the property owner.
- f) Maintenance. Electric vehicle charging stations shall be maintained in all respects, including the functioning of the equipment. A phone number or other contact information shall be provided on the equipment for reporting when it is not functioning or other problems are encountered.
- g) Emergency Disconnect. For Electric Vehicle Charging Stations rated at more than 60 amps or more than 150 volts to ground, a means of disconnect must be installed in a readily accessible location and within sight of the electric charging connector. If the disconnect is not in sight of the equipment, it must be capable of being locked in the open position.
- h) Decommissioning. Unless otherwise directed by the City of Dallas, within ninety (90) days of cessation of use of the electric vehicle charging station, the property owner or operator shall restore the site to its original condition. Should the property owner or operator fail to complete said removal within ninety (90) days, the City of Dallas shall conduct the removal and disposal of improvements at the property owner or operator’s sole cost and expense.
- i) Appeals. If the owner of an electric vehicle charging station is found to be in violation of the provisions of this Ordinance, appeals should be made in accordance with the established procedures of the local government code.

**THIS PAGE INTENTIONALLY LEFT BLANK**

CHAPTER IX: DESIGN STANDARDS

**Sec. 9.01 – RESIDENTIAL DESIGN STANDARDS**

All new single-family homes shall include the following minimum design standards.

- 1) **APPLICABILITY.** These standards shall apply to new single-family detached and two-family dwellings in major and minor subdivisions. Existing residential structures that expand or are altered by more than thirty -five (35) percent of the existing square footage shall also comply.
  - a) All changes of use proposed within existing structures on developed parcels shall be exempt from all supplementary regulations within this ordinance except parking, lighting and landscaping requirements.
  - b) All changes of use proposed within new structures or structures expanded beyond 35% of the existing structure’s square footage on developed parcels shall be subject to all applicable regulations within this ordinance as set forth herein.
  - c) All changes of use proposed within existing buildings, new buildings, or buildings expanded beyond thirty-five percent (35%) of the existing structure’s square footage, and located on underdeveloped or undeveloped lots shall be subject to all applicable regulations within this ordinance as set forth herein.

Table 9.1: Change of Use Chart

	Undeveloped Lot	Underdeveloped Lot	Developed Lot
Existing structure	N/A	All regulations	Parking, Lighting and Landscaping Regulations
Expansions beyond 35% of a structure’s square footage	N/A	All regulations	All regulations
New Structure	All regulations	All regulations	All regulations

- 2) **ANTI-MONOTONY.** Homes located in close proximity shall not be of the same front elevation. This does not prohibit the home to the rear from being the same front elevation.
  - a) Mirror images of the same configuration/elevation do not meet the requirement.
  - b) No house shall be of the same front elevation design as any other house within two houses to each side of the subject lot nor directly across the street.
  - c) No single front elevation design may be applied to more than twenty-five (25%) percent of the front elevations within any single phase of a development.
- 3) **PEDESTRIAN CIRCULATION.** A sidewalk with a minimum five (5) foot width shall be included in developments of four (4) homes or more. A determination shall be made by the Director regarding infill lots.
- 4) **Utility Standards.**
  - a) Mechanical features shall not be located in the supplemental area or front yard and shall be screened from view from any park or along any public right-of-way with planting, walls or fences of equal or greater height. Acceptable materials for screening shall include those materials found in *Sec. 7.09 – Fences, Walls, and Hedges*, provided they are compatible with the principal structure.

- b) When located on rooftops, mechanical features shall be incorporated in the design of the building and screened with materials similar to the building.
  - c) Street lights may be provided by the developer in an effort to maintain a safe, walkable and well-lit public area throughout the city; pedestrian-scale street lights as approved by the Department of Community Development shall be provided by the developer, subject to site plan and design review in new development.
  - d) All developments shall provide a light at the front door. Lighting designed to illuminate the path to the front door is allowed. Spotlighting may be provided as long as it is properly shielded and does not become an annoyance to adjacent property owners or the public. General area illumination with oversized flood lights is prohibited. Specifically, lighting shall be shielded so that the source of light is not visible from adjacent properties or the public right-of-way.
  - e) Trees shall not be planted directly above storm drains. Trees shall not be planted in the public right-of-way.
  - f) LANDSCAPING. All single-family dwellings shall be landscaped in conformance with *Section 7.05 – Landscaping Standards*.
- 5) Parking and Traffic Standards.
- a) One-family detached dwellings and two-family dwellings shall meet the following requirements:
    - i) Driveways shall have a minimum width of nine feet and a maximum width of fifteen (15) feet.
    - ii) Circular drives are permitted.
    - iii) A grass strip in the middle of driveways is encouraged.
  - b) All other buildings shall meet the following requirements:
    - i) Parcels are permitted a maximum of one driveway curb cut per street. In cases where a property abuts multiple streets the total number of curb cuts or portions thereof may be allocated to a single street.
    - ii) Driveways shall have a maximum width of twelve (12) feet for one-way and twenty-four (24) feet for two-way.
    - iii) Two curb cuts serving two one-way driveways shall be counted as one curb cut.
    - iv) Public or private alleys, or driveway providing vehicular access to two or more parcels shall not constitute a curb cut.
    - v) New public streets shall not count as curb cuts.
  - c) Carports are only permitted subject to the following requirements:
    - i) Carports shall be located in the rear or side yard, but shall not be visible from a public right-of-way. The Community Development Director may approve an exemption where the enforcement of this provision is impractical due to environmental factors.
    - ii) Carport roofs shall be supported by columns with a minimum width and depth of eight inches.
    - iii) The base of carport columns shall be faced in stacked brick or stacked stone to a minimum height of three (3) feet above grade.
  - d) On-site parking shall be prohibited in the supplemental areas. This shall not be interpreted as restricting on-street parking located along a public street.
- 6) Roof and Chimney Standards.
- e) Principal building roofs for one-family detached dwellings shall have a minimum usable life of thirty (30) years, per manufacturer's warranty.

- f) Roof shingles shall be slate, cedar, or asphalt.
  - g) Roof tiles shall be clay, terra cotta or concrete.
  - h) Metal roofs are:
    - i) Permitted on one-family and two-family detached dwellings if approved by the technical advisory committee; and
    - ii) Permitted on multifamily and townhouse dwellings only when screened from the adjacent street by a parapet wall.
  - i) Gutters shall be copper, aluminum or galvanized steel.
  - j) Downspouts shall match gutters in material and finish.
  - k) Roof forms shall be based on architectural style.
  - l) All roofs, excluding dormers, shall overhang a minimum of twelve (12) inches beyond the facade. Buildings with sloped roofs not completely screened from the adjacent street by a parapet shall have a pitch between 4:12 and 12:12.
  - m) Dormers are permitted on all style homes (unless specified), but shall not be taller than the main roof to which they are attached.
  - n) Chimneys exposed to the public view may not be faced in wood or cement-based siding and may not be of an exposed metal or ceramic pipe. All chimneys shall be wrapped in a brick, stone or suitable masonry finish material.
  - o) Chimneys on exterior building walls shall begin at grade.
  - p) Chimneys shall begin at grade and be faced with brick or stacked stone; extend chimneys between three and six feet above the roof line.
- 7) Street Facing Facade and Style Standards.
- a) Exterior facade materials shall be limited to:
    - i) Full-depth brick;
    - ii) Natural or cast stone;
    - iii) Smooth natural-wood siding and/or cement-based siding;
    - iv) Shake siding;
    - v) Painted fish-scale style shingles, but only when used in front gables;
    - vi) True, smooth hard-coat stucco, provided that its use is limited to gables of Tudor revival-style buildings.
  - b) Exterior building materials shall not be:
    - i) Simulated brick veneer, such as Z-Brick;
    - ii) Exterior insulation and finish systems (EIFS);
    - iii) Exposed concrete block;
    - iv) Metal siding or other metal exterior treatment;
    - v) Glass curtain walls;
    - vi) T-1-11 siding;
    - vii) Vinyl and aluminum siding
  - c) Each front elevation shall include architectural elements from the following list that total a minimum of six (6) points. Unless specified, all features are worth one (1) point.
    - i) Front porch, minimum eight (8) feet in width and six (6) feet in clear depth supported by columns and with a rail (2 points)
    - ii) Side-loaded or court-entry garage (2 points)
    - iii) A separate overhead door for each single garage bay

- iv) Brick, stone or textured concrete masonry on one-hundred (100%) percent of the front elevation (excluding openings)
- v) Turret
- vi) Two (2) or more roof planes visible (change in elevation or direction of roof ridge) on the front of the house
- vii) Veranda/balcony
- viii) At least four (4) feet of relief at one or more points along the front or rear elevations
- ix) Bay, dormer or oriel windows
- x) Decorative geometric front, rear and side gable roof vents or windows
- xi) Architectural details such as quoins, pilasters, cornices, and dentil molding
- xii) Architectural-grade roof shingles
- xiii) Dormer windows/shed dormer
- xiv) Architectural brackets or corbels
- xv) Chimneys beginning at grade and faced with brick or stacked stone; extend chimneys between three and six feet above the roof line
- xvi) Mullions, muttons, true divided lights on the exterior of the window surface
- xvii) Shutters, each, half the width of the adjacent window, mounted with shutter hinge and anchor hardware; not mounted directly to the surface of the adjoining façade
- d) Facade materials shall be combined horizontally, with the heavier below the lighter.
- e) Blank, windowless walls are prohibited along all facades.
- f) Foundations shall be constructed as a distinct building element that contrasts with facade materials. Foundations that are exposed above the ground, must be parged with cement, stuccoed over or be faced in brick, natural stone, or cast stone.
- g) All exterior stair risers visible from a street shall be enclosed.
- h) Porches, stoops, and balconies may be located in the front or side yard.
- i) Porches, stoops, and balconies along front and side building facades shall not be enclosed with screens, plastics, or other materials that hinder visibility and/or natural air flow.
- j) Porches, stoops, and balconies shall be made of painted or stained wood, stone, brick, or ornamental metal, subject to the additional restrictions below.
- k) Wooden porches, stoops, and balconies shall provide top and bottom horizontal members on railings. The top railing shall consist of two elements. The upper element shall measure two [inches] by six inches and the lower element shall measure two [inches] by four inches. The bottom railing shall measure two [inches] by four inches.
- l) Front porches and front stoops of principal buildings shall face and be parallel to the front lot line or build-to line.
- m) Porch and stoop foundations shall be enclosed.
- n) Front and side porches and stoops shall not have unpainted, unstained or otherwise untreated or exposed pressure treated lumber along the building line that abuts a public right-of-way.
- o) Balconies shall have not less than two clear unobstructed open or partially open sides. Partially open is to be constructed as fifty (50) percent open or more. The total combined length of the open or partially open sides shall exceed fifty (50) percent of the total balcony perimeter.

- p) Stoops and porch[es] shall be a minimum of two feet and a maximum of four feet from grade to the top of the stairs, unless existing topography is greater.
  - q) Stoops shall provide a minimum top landing of four feet by four feet.
  - r) Stoop stairs and landings shall be of similar width.
  - s) Stoops may be covered or uncovered.
  - t) When provided, porches shall have a minimum clear depth of eight feet from building facade to outside face of column.
  - u) Front porch widths shall be between eighty (80%) percent and one-hundred (100%) percent of the adjacent facade.
  - v) Side porch widths (including wraparound porches) shall be between twenty-five (25%) percent and one-hundred (100%) percent of the adjacent facade.
  - w) Enfronting porches may have multistory verandas, living space, or balconies above.
  - x) Porch columns shall be spaced a maximum distance of eight feet on center.
  - y) Front porch columns shall have foundation piers extending to grade.
  - z) All porches shall be covered.
  - aa) Enfronting balconies are only permitted on attached or detached one-family home facades when porches are not provided on said facades.
  - bb) Enfronting balconies shall have a minimum clear depth of four feet.
  - cc) Enfronting balcony widths shall be between twenty-five (25%) percent and one-hundred (100%) percent of the adjacent facade.
  - dd) Balconies may be covered or uncovered
- 8) SIDE AND REAR FACADE. The side and rear elevations of a home which abut a right-of-way or private street, excluding alleys, and can be viewed from that street shall have at least two (2) of the following features on all sides:
- a) Full first-floor masonry wrap
  - b) Pop-out room a minimum of three (3) feet by ten (10) feet such as sun room or breakfast nook (on viewable sides)
  - c) Screen porch (on viewable sides)
  - d) Bay or oriel windows (on viewable sides)
  - e) Shutters and window grids
  - f) Cantilevered second story (on viewable sides)
  - g) Raised wood deck, a minimum of eight (8) feet by ten (10) feet (on viewable sides)
- 9) Door and Window Standards.
- a) The main entry door to enfronting principal buildings shall face, be visible from, and be accessible from the adjacent public sidewalk.
  - b) The main entry door to all uses shall be linked to the sidewalk via a pedestrian walkway or wheelchair access.
  - c) Building numbers at least six inches in height shall be located above or beside the street-facing pedestrian entrance, or above or beside the stairs accessing a front porch.
  - d) Doors that operate as sliders are prohibited along enfronting facades.
  - e) Window panes shall be recessed a minimum of three inches and a maximum of eight inches

from the adjacent facade, except on frame houses, on which panes shall be recessed a minimum of two inches.

- f) Where windows lights are utilized they shall be true divided lights, simulated divided lights, or one-over-one lights. Grids-between-glass (GBGs) are prohibited.
- g) Window trim shall not be flush with the exterior facade and shall provide a minimum relief of one-quarter inch or greater.
- h) Where used, window shutters shall match one-half the width of the window opening, and mounted with shutter hinge and anchor hardware; not mounted directly to the surface of the adjoining façade.
- i) Painted window or door glass is prohibited.
- j) Enfronting windows and door glass (except on churches and fire stations) shall utilize clear glass or tinted glass. Tinted glass shall have a transmittance factor of 50 percent or greater and shall have a visible light reflectance factor of ten or less.
- k) Windows shall be provided for a minimum of thirty (30%) percent and a maximum of 50 percent of the total street-facing facade of the principal building, with each facade and story calculated independently.
- l) Street-facing window units shall not exceed twenty-eight (28) square feet with minimum height of three feet, with the exception of transoms and fan lights.
- m) Wood trim between four and six inches wide shall surround windows, doors and corner trim of wood frame structures. Windows grouped together shall have center mullions two inches wider than the side trim.
- n) Sills shall be of masonry, wood, stone, cast stone, or terra cotta.

#### **Sec. 9.02 – MULTIFAMILY AND TOWNHOME DESIGN STANDARDS**

- 1) APPLICABILITY. All new multi-family developments (apartments, townhomes) of three (3) units or more are subject to the following standards.
- 2) FAÇADE.
  - a) Variation. Architectural detailing, horizontal/vertical offsets, window details and other features shall be provided on all sides of the building to avoid featureless building massing, enhance character and style, and reduce the visual scale.
  - b) Buildings with continuous facades that are ninety (90) feet or greater in width shall be designed with offsets (projecting or recessed) not less than two (2) feet deep, and at intervals of not greater than sixty (60) feet.
  - c) Materials shall be durable and attractive. Visually heavier materials should be used as the building's foundation. Prohibited materials shall be as indicated in Section 9.01(7)(b).
    - i) Exposed foundations shall be constructed of one or more of the following:
      - (1) Brick;
      - (2) Wood shake siding;
      - (3) Stone (limestone, granite, fieldstone, etc.); or
      - (4) Split-face, integrally-colored block or architectural pre-cast concrete that simulates natural material.
    - ii) Facade walls shall be constructed of any combination of the following. A minimum of forty (40%) percent shall be masonry.

- (1) Stone;
  - (2) Wood clapboard siding;
  - (3) Brick;
  - (4) Stucco or “Drained” External Insulation and Finish System (Drainable E.I.F.S.), not to exceed twenty (20%) percent of the overall non-window facade area; or
  - (5) Cement fiber board (e.g., “Hardiplank”).
- iii) Facade Plane projections such as the following are encouraged:
- (1) Veranda/balcony
  - (2) Sunroom
  - (3) Screened porch
  - (4) Breakfast nook
  - (5) Turret
- iv) The facades of townhomes shall be detailed to differentiate individual units.
- 3) ENTRIES. Entries shall be pedestrian-scaled and clearly defined and accented with such features as awnings, porticos, overhangs, recesses/projections, arcades, raised corniced parapets over the door, peaked roof forms and arches.
- a) The primary entryway for townhomes shall not be recessed. Entries shall not protrude from the dominant front façade wall more than 3’.
  - b) At a minimum, the entry should incorporate features totaling a minimum of two (2) points from the list below. Unless specified, all features are worth one (1) point.
    - i.) Porches a minimum depth of four (4) feet and at least eight (8) feet in length, and that includes posts and railings (2 points)
    - ii.) Decorative trim/molding
    - iii.) Keystone
    - iv.) Portico or shed roof accent over entry
    - v.) Pent roof
    - vi.) Transom window
    - vii.) Door sidelights
    - viii.) Covered front stoop
- 4) ROOF.
- a) Minimum Pitch for pitched roofs shall be five feet for every twelve feet (5:12) of rise over run.
  - b) Materials. Quality roof materials such as tile, slate, standing-seam metal, three-dimensional asphalt or fiberglass shingles shall be used on all structures.
  - c) Minimum Eave/Overhang Width. All multifamily buildings shall have eaves or overhangs a minimum of twelve (12) inches deep on all sides.
  - d) Roof Articulation. Roofs shall display a variety of forms and articulation to reduce apparent scale. Elements such as dormers, gables, cross gables, hipped, secondary hipped or gabled roofs can be

used to achieve this appearance.

- e) Flat roofs shall contain a cornice or molding, and vary in height or shape every fifty (50) feet.
  - f) Rooftop mechanical equipment shall either be fully screened with architecturally compatible materials on all sides or visually integrated into the overall design of the building. In no case shall rooftop mechanical equipment be visible from adjoining streets, residential zones or uses.
- 5) AUTOMOBILE STORAGE.
- a) Garage Access. Except for structured parking decks, all attached garages shall provide access internally from the garage to individual units.
  - b) Minimum garage width shall be sixteen (16) feet.
  - c) Carport. Where established, carports shall:
    - i) Meet all setback standards around the perimeter of the site applicable to a primary structure.
    - ii) Be designed in keeping with the primary structure, and the materials shall be compatible with those of the primary structure.
  - d) No more than two (2) garage structures shall be located adjacent to each other end-to-end.
  - e) All townhomes shall have at minimum a two-car garage.
  - f) Townhome developments are required to have rear-facing garage doors.
- 6) HEIGHT. All townhomes are required to have a minimum of three (3) stories in height, inclusive of the garage.
- 7) WINDOWS. Windows are required on all sides of the building that are:
- a) Adjacent to a street; or
  - b) Adjacent to a common area.
  - c) Windows should be enhanced with divided lights, grids, transom windows, keystone, lintels or trim/architrave.
- 8) DESIGN COMPATIBILITY. All structures within the multifamily development shall be compatible. Similar styles, color, architectural detail and materials shall be used for garages, carports, grouped mailboxes, laundry facilities, clubhouses, shelters, etc.
- 9) MECHANICAL AND UTILITY EQUIPMENT SCREENING. All mechanical equipment including ground-, roof-, and building-mounted, shall be completely screened from view. Screening can be achieved by landscaping, fences or walls for ground-placed equipment, and the use of parapet walls or other roof designs for roof-mounted equipment. Screening enclosures shall be architecturally compatible with the primary structure.
- 10) DUMPSTER AND STORAGE ENCLOSURE SCREENING. Dumpsters and storage area screening shall conform to the regulations of *Section 7.05 – Landscaping Standards*.
- 11) LANDSCAPING. Landscaping requirements are set forth in *Section 7.05 – Landscaping Standards*.
- 12) LIGHTING. Standards for parking lot, site and building lighting are set forth in *Section 7.12 – Outdoor Lighting*.
- 13) NOISE AND VIBRATION STANDARDS. In residential/commercial mixed-use developments, the International Building Code (IBC) provides a minimum design requirement for unit-to-unit acoustical protection between floors. It requires a Sound Transmission Class (STC) rating or Impact Insulation Class (IIC) rating of 50. The International Residential Code (IRC) requires a minimum design separation of STC 45 for townhouses.

- a) Scope. This section shall apply to common interior walls, partitions and floor/ceiling assemblies between adjacent dwelling units or between dwelling units and adjacent public areas such as halls, corridors, stairs or service areas.
- b) Airborne sound. Walls, partitions and floor/ceiling assemblies separating dwelling units from each other or from public or service areas shall have a sound transmission class (STC) of not less than 50 (45 if field tested) for air-borne noise when tested in accordance with ASTM E 90. Penetrations or openings in construction assemblies for piping; electrical devices; recessed cabinets; bathtubs; soffits; or heating, ventilating or exhaust ducts shall be sealed, lined, insulated or otherwise treated to maintain the required ratings. This requirement shall not apply to dwelling unit entrance doors; however, such doors shall be tight fitting to the frame and sill.
- c) Structure-borne sound. Floor/ceiling assemblies between dwelling units or between a dwelling unit and a public or service area within the structure shall have an impact insulation class (IIC) rating of not less than 50 (45 if field tested) when tested in accordance with ASTM E 492(09).
- d) Notwithstanding other sections of this title, it shall be unlawful for any person to create, maintain or cause any ground vibration which is perceptible without instruments at any point on any affected property adjoining the property on which the vibration source is located. For the purpose of this title, the perception threshold shall be presumed to be more than 0.05 inches per second RMS vertical velocity.

### Sec. 9.03 – NON-RESIDENTIAL DESIGN STANDARDS

- 1) APPLICABILITY. All non-residential development, with the exception of agricultural uses in agricultural zoning districts, shall meet or exceed the requirements of this section, in addition to all other applicable development standards established by this Ordinance. These non-residential standards shall apply to the following:
  - a) New structures with permits submitted on or after the effective date of this ordinance;
  - b) Expansions greater than thirty-five (35%) percent of pre-existing site, structure or building; and
  - c) Expansions to structures that may be less than thirty-five (35%) percent but result in a structural addition greater than 20,000 square feet in gross floor area.
  - d) Changes of use to a permitted use.
- 2) SITE LAYOUT
  - a) Site planning which encourages compatibility between the site and the buildings and between all buildings on the site is encouraged. Where natural or existing topographic patterns contribute to a development, they shall be preserved and integrated. Modification to topography shall be permitted where it contributes to the overall development.
  - b) The orientation of buildings shall promote interaction with the street or city road and provide a pedestrian friendly environment. All primary and outparcel site buildings shall be arranged so that they complement existing development. The buildings shall frame a corner or enclose a “main street” type corridor. Buildings on islands surrounded by parking should be avoided.
  - c) Newly installed infrastructure and service revisions necessitated by exterior alterations shall be underground. To the extent possible, all existing overhead utilities shall be relocated underground.
- 3) ARCHITECTURAL DESIGN. All non-residential building walls shall have architectural features which

increase visual interest, reduce undifferentiated masses and relate to the pedestrian scale.

- a) Facades. Facades shall have a defined base or foundation, a middle or modulated wall, and a top formed by a pitched roof or articulated cornice, in each instance appropriate to the building style.
- b) Offsets and Projections. Buildings with continuous facades that are ninety (90) feet or greater in width shall be designed with offsets (projecting or recessed) not less than two (2) feet deep, and over intervals of not greater than sixty (60) feet. Industrial developments are exempt from this requirement.
- c) Storefronts. Ground-floor retail shall be transparent for seventy-five (75%) percent of the total ground level facade. Industrial developments are exempt from this requirement.
- d) Exterior materials. Building facades may be constructed from wood, stone, masonry, E.I.F.S., hard-coat stucco, cement fiber board, split-face, textured concrete, metal or glass or other materials which provide the same desired quality. Similar building materials should be used throughout a development with multiple buildings. Products other than those listed below must be approved by the Community Development Director or his/her duly appointed designees.
  - i) Buildings constructed of metal shall be permitted only in the Industrial, Medium-Density (I-2) districts.
    - (1) Buildings that do not exceed fifty (50%) percent metal shall be permitted in the Industrial, Low-Density (I-1) and Commercial, Medium-Density (C-2) zoning districts, and must contain other design elements such as concrete or masonry bases, pitched roofs, enhanced entries or color variation.
  - ii) Structures shall be constructed using a minimum of fifty (50%) percent masonry as described below.
    - (1) Masonry construction may consist of brick, granite, sandstone, slate, limestone, marble, or other hard and durable all-weather stone. Ashlar, cut stone, and dimension stone construction techniques are acceptable.
    - (2) Brick material used for masonry construction shall be composed of hard-fired all-weather standard size brick or other all-weather facing brick.
    - (3) Concrete finish or precast concrete panels shall be textured using the following techniques: exposed aggregate, bush-hammered, sand-blasted, or other concrete finish as approved by the Director or his/her duly appointed designee. Concrete masonry units (CMU or block) shall be textured or split-face, and otherwise not smooth.
    - (4) Office uses may use: Architectural metal panels, glass (up to 75% of the façade area) and ornamental metal.
- e) Roof Design. The materials and finishes for roofs shall complement those materials used for the exterior walls. Roofs may be pitched, use stepped parapet walls, three dimensional cornices, dimensioned or integrally-textured materials, or be sloped with overhangs and brackets. Parapets shall not exceed more than one-third (1/3) the height of the supporting wall (above the floor of which they are located).
- f) Four-sided Architecture. The architectural style, materials, color and design on the front elevation shall be applied to all elevations of the structure adjacent to a public street, primary internal drive or residential zoning district.
  - i) Blank, windowless walls are prohibited along facades enfronting a public way, except where

a building enfronts multiple streets. In the latter case, it was not historically uncommon for buildings (especially commercial or mixed-use ones) to orient towards the more intensely developed street. As such, along the first story of enfronting mixed-use and commercial facades this requirement may be waived by the Director along streets that are predominantly residential in character when:

- (1) The first twenty (20) feet of said facade meets the above requirements, and
  - (2) The area beyond the first twenty (20) feet is treated with architectural detailing, such as pilasters, false windows, or similar features.
- g) Color. Compatible materials and colors should be used throughout to unify development. The colors should reflect natural tones of the environment and be subtle, harmonious and non-reflective. Accents shall be compatible.
- h) Entry Features. Entryway features are only required at the primary entrance to the structure and shall include elements such as: covered entries, integral planters, awnings, raised corniced parapets over the door, peaked roof forms having an average slope greater than or equal to a minimum 5:12 pitch, arches, or architectural details such as tile work and moldings that are integrated into the building structure and design.
- 4) MAINTENANCE. The exposed walls and roofs of buildings shall be maintained in a clean, orderly, and attractive condition, and be free of cracks, dents, punctures, breakage, and other forms of visible marring. Materials that become excessively faded, chalked, or otherwise deteriorated shall be refinished, repainted, or replaced.
- a) Refuse and waste removal areas, loading berths, service yards, storage yards, and exterior work areas shall be screened from view with fencing, walls or landscaping.
  - b) All accessory buildings and structures shall be constructed with materials that are similar and compatible with materials used in the principal structure.
- 5) MECHANICAL EQUIPMENT SCREENING AND PLACEMENT.
- a) Roof-mounted equipment on exposed roofs shall be completely screened from view. The appearance of roof screens shall be coordinated with the building to maintain a unified appearance.
  - b) All ground- and building-mounted mechanical and electrical equipment shall be screened from view. The screens and enclosures shall be treated as an integral element of the building's appearance. Landscaping may be used for this purpose.
  - c) Ground-mounted, commercial-grade mechanical equipment such as walk-in freezers.
    - i) Design. The unit shall be screened by a masonry wall that complements the architecture of the primary structure. Walls attached to the primary structure shall be designed as an architecturally integrated part of the primary structure. The wall shall be sufficient to dampen any noise generated while the unit is in operation.
    - ii) Height. The wall shall be equal to the height of the unit plus two (2) feet.
    - iii) Access. The enclosure shall be accessed via an opaque gate.
    - iv) Orientation. The gate shall not face a residential property, or a right-of-way within fifty (50)

feet.

- v) Setback. All mechanical equipment shall be located a minimum of fifty (50) feet from the property line, and shall not be located within a front or side setback.
- d) Utility substations shall be screened with a fence that is at least fifty (50%) percent opaque and at least eight (8) feet in height, and the exterior wall of the fence shall be landscaped with a Type 1 Buffer yard comprised solely of evergreen species.
  - i) The fence may not be chain-link.
- 6) SIGN STANDARDS. Signage shall be designed to be an integral part of the architectural and landscaping plans. The colors, materials, and style of signage shall be architecturally compatible and accentuate the buildings and landscaping on the site. The colors, materials, and lighting of every sign shall be restrained and harmonious with the building and site to which it principally relates. Signs shall be in conformance with the *Dallas Sign Ordinance*.
- 7) LANDSCAPE PLAN. Landscaping shall be in conformance with *Section 7.05 – Landscaping Standards*. Plans shall be prepared and submitted with the Development Plan.
  - a) Landscaping materials selected should be appropriate to local growing and climatic conditions. Wherever appropriate, existing trees should be conserved and integrated into the landscaping plan; credit toward required in-kind landscaping may be given.
- 8) SITE AMENITIES. Site amenities provide attractive spaces and the possibility of interaction. Site amenities such as patios, plazas, mini-parks, squares, water features and public art should be incorporated in the required open space for the development.
- 9) LIGHTING. Lighting shall be in conformance with *Section 7.12– Outdoor Lighting*.
- 10) OPERATIONAL COMPATIBILITY WITH SURROUNDING DEVELOPMENT. The Planning & Zoning Commission may impose conditions on the approval of a project including but not limited to:
  - a) the placement of trash receptacles;
  - b) location of delivery and loading zones;
  - c) hours of refuse removal; and
  - d) hours of sign illumination.
- 11) MODIFICATION. The Planning & Zoning Commission, City Council and Zoning Board of Appeals shall have the authority to modify any of the requirements of this section.

#### **Sec. 9.04 – COMMUNITY DESIGN CONSIDERATIONS**

- 1) INTERIOR RUMBLE STRIPS. Rumble strips should be installed adjacent to raised medians or other interior curbs to draw attention to the presence of the median during adverse weather conditions or other circumstances where visibility is low. Rumble strips should be designed so that adverse riding conditions are not created for on-street cyclists.
- 2) NEIGHBORHOOD STREET LIGHTING. Lights should be installed along neighborhood streets. They should be no taller than twenty (20) feet and should be fully shielded or full cutoff fixtures.
- 3) STREET ADDRESSES. Business and residence address lettering should be a minimum height of six (6)

inches, should take into consideration the contrast of lettering and background colors, and should be externally illuminated.

- 4) STREET ELEMENTS. The community should work with GDOT to encourage increased pavement markings standards, brighter stop lights, and larger and/or easily readable letters for street names/street signs.
- 5) STREET WIDTH. Street width and right-of-way easement requirements should take into consideration the necessary width of roadways through low-traffic, residential neighborhoods. Large road widths can interrupt the benefits of high-density neighborhoods and the safety of pedestrians who cross the street.
- 5) TRANSPORTATION. Safe and nearby pedestrian walkways/trailways, bikeways, and public transit should be created to increase a residence's visitability and aid in transportation accessibility for individuals without motor vehicle access.

**THIS PAGE INTENTIONALLY LEFT BLANK**

## CHAPTER X – HISTORIC PRESERVATION

Sec. 10.01 – HISTORIC PRESERVATION

---

## 1) Purpose

- a) In support and furtherance of its findings and determination that the historical, cultural and aesthetic heritage of the City of Dallas is among its most valued and important assets and that the preservation of this heritage is essential to the promotion of the health, prosperity and general welfare of the people;
- b) In order to stimulate revitalization of the business districts and historic neighborhoods and to protect and enhance local historic and aesthetic attractions to tourists and thereby promote and stimulate business;
- c) In order to enhance the opportunities for federal or state tax benefits under relevant provisions of federal or state law; and
- d) In order to provide for the designation, protection, preservation and rehabilitation of historic properties and historic districts and to participate in federal or state programs to do the same;
- e) The Dallas City Council hereby declares it to be the purpose and intent of this Ordinance to establish a uniform procedure for use in providing for the protection, enhancement, perpetuation and use of places, districts, sites, buildings, structures, objects, and landscape features having a special historical, cultural or aesthetic interest or value, in accordance with the provisions of the Ordinance.

## 2) Definitions.

- a) Building – A building is a structure created to shelter any form of human activity, such as a house, barn, church, hotel or similar structure. Building may refer to a historically related complex such as a courthouse and jail or a house and barn.
- b) Certificate of Appropriateness – Means a document evidencing approval by the Historic Preservation Commission of an application to make a material change in the appearance of a designated historic property or of a property located within a designated historic district.
- c) Exterior Architectural Features – Means the architectural style, general design and general arrangement of the exterior of a building, structure or object, including but not limited to the kind or texture of the building material and the type and style of all windows, doors, signs and other appurtenant architectural fixtures, features, details or elements relative to the forgoing.
- d) Exterior Environmental Features – Means all those aspects of the landscape or the development of a site which affect the historic character of the property.
- e) Historic District – Means a geographically definable area, possessing a significant concentration, linkage, or continuity of sites, buildings, structures or objects united by past events or aesthetically by plan or physical development. A district may also comprise individual elements separated geographically but linked by association or history. A Historic District shall further mean an area designated by the Dallas City Council as a Historic District pursuant to the criteria established in *Subsection 10.01(4)b* of this Ordinance.
- f) Historic Property – Means an individual building, structure, site, or object including the adjacent area necessary for the proper appreciation thereof designated by the Dallas City Council as a historic property pursuant to the criteria established in *Subsection 10.01(4)c* of this Ordinance.

- g) Material Change in Appearance – Means a change that will affect either the exterior architectural or environmental features of a historic property or any building, structure, site, object, or landscape feature within a historic district, such as:
    - i) A reconstruction or alteration of the size, shape or façade of a historic property, including relocation of any doors or windows or removal or alteration of any architectural features, details or elements;
    - ii) Demolition or relocation of a historic structure;
    - iii) Commencement of excavation for construction purposes;
    - iv) A change in the location of advertising visible from the public right-of-way; or
    - v) The erection, alteration, restoration or removal of any buildings or other structure within a historic property or district, including walls, fences, steps and pavements, or other appurtenant features, except exterior paint alterations.
  - h) Object – An object is a material thing of functional, aesthetic, cultural, historical or scientific value that may be, by nature or design, movable yet related to a specific setting or environment.
  - i) Site – A site is the location of a significant event, a prehistoric or historical occupation or activity, or a building or structure, whether standing, ruined, or vanished, where the location itself maintains historical or archaeological value regardless of the value of any existing structure.
  - j) Structure – A structure is a work made up of interdependent and inter-related parts in a definite pattern of organization. Constructed by man, it is often an engineering project large in scale.
- 3) Commission’s Power to Adopt Rules and Standards:
- a) The Preservation Commission shall adopt rules and standards for the transaction of its business and for consideration of application for designation of Certificates of Appropriateness, such as by-laws, removal of membership provision, and design guidelines and criteria. The Preservation Commission shall have the flexibility to adopt rules and standards without amendment to this Ordinance. The Commission shall provide for the time and place of regular meetings and a method for the calling of special meetings. The Commission shall select such officers as it deems appropriate from among its members. A quorum shall consist of a majority of the members.
  - b) Conflict of Interest:
    - i) Commission shall be subject to all conflict-of-interest laws set forth in Georgia Statutes and in the City of Dallas Charters.
  - c) Commission’s Authority to Receive Funding from Various Sources:
    - i) The Commission shall have the authority to accept donations and shall ensure that these funds do not displace appropriated governmental funds.
  - d) Records of Commission Meetings:
    - i) A public record shall be kept of the Commission resolution, proceedings and actions.
  - e) City Staffing for the Historic Preservation Commission:
    - i) The Director of Community Development shall appoint a staff delegate to provide technical and administrative assistance to the Commission. This staff appointee shall remain an employee to the City, and support of the Historic Preservation Commission shall be an ancillary function to the appointee’s primary job responsibilities.
    - ii) Staff availability to the Commission will be dictated by formal applications for a Certificate of Appropriateness filed with the Community Development Department.
    - iii) Requests for technical assistance from staff or hired consultants shall be requested by the Commission and approved, denied, or programed based on the availability of department

- funding, and the availability of staff beyond the appointee’s primary job responsibilities.
- iv) Absent a formal application filed with the City, the Commission may request a Special Called Meeting to discuss strategic planning, and rules and policies of the Commission. However, staff availability may be limited, and no official action shall be taken by the Commission until a formal meeting has been scheduled by the City.
- 4) Recommendation and Designation of Historic Districts and Properties
- a) Preliminary Research by the Commission:
    - i) Commission’s Mandate to Conduct a Survey of Local Historical Resources: The Commission shall compile and collect information and conduct surveys of historic resources within the City of Dallas.
    - ii) Commission’s Power to Recommend Districts and Buildings to the Dallas City Council for Designation: The Commission shall present to the Dallas City Council recommendations for historic districts and properties.
    - iii) Commission’s Documentation of Proposed Designation: Prior to the Commission’s recommendation of a historic district or historic property to the Dallas City Council for designation, the Commission shall prepare a Report for Nomination consisting of:
      - (a) a physical description;
      - (b) a statement of the historical, cultural, architectural and/or aesthetic significance;
      - (c) a map showing district boundaries and classification, i.e. contributing, non-contributing, of individual properties therein, or showing boundaries of individual historic properties; and
      - (d) representative photographs.
  - b) Designation of a Historic District:
    - i) Criteria for selection of historic district: A historic district is a geographically definable area, which contains buildings, structures, sites, objects, and landscape features or a combination thereof, which:
      - (1) has special character or special historic/aesthetic value or interest;
      - (2) represents one or more periods, styles or types of architecture typical of one or more eras in the history of the municipality, county, state or region; and
      - (3) causes such area, by reason of such factors, to constitute a visibly perceptible section of the municipality.
    - ii) Boundaries of a Historic District: Boundaries of a Historic District shall be included in the separate ordinances designating such districts and shall be shown on the Official Zoning Map of the City of Dallas, or in the absence of zoning, on an official map designated as a public record.
    - iii) Evaluation of properties within Historic District: Individual properties within historic districts shall be classified as:
      - (1) Contributing (contributes to the district); or
      - (2) Non-contributing (does not contribute to the district).
  - c) Designation of a Historic Property:
    - i) A historic property is a building, structure, site, or object; including the adjacent area necessary for the proper appreciation or use thereof, which:

- d) Criteria for selection of Historic Properties: A historic property is a building, structure, site, or object; including the adjacent area necessary for the proper appreciation or use thereof, deemed worthy of preservation by reason of value to the City of Dallas, the region or the State of Georgia for one of the following reasons:
- (a) it is an outstanding example of a structure representative of its era;
  - (b) it is one of the few remaining examples of a past architectural style;
  - (c) it is a place or structure associated with an event or persons of historic or cultural significance to the City of Dallas, State of Georgia, or the region; or
  - (d) it is the site of natural or aesthetic interest that is continuing to contribute to the cultural or historical development and heritage of the municipality, county, state or region.
- e) Requirements for Adopting an Ordinance for the Designation of Historic Districts and Historic Properties:
- i) Application for Designation of Historic Districts of Property: Designations may be proposed by the Dallas City Council, the Commission, or:
    - (1) for historic districts – a historical society, neighborhood association or group of property owners may apply to the Commission for designation;
    - (2) for historic properties – a historical society, neighborhood association or property owner may apply to the Commission for designation.
  - ii) Required Components of a Designation Ordinance: Any ordinance designating any property or district as historic shall:
    - (1) list each property in a proposed historic district or describe the proposed individual historic property;
    - (2) set forth the name(s) of the owner(s) of the designated property or properties;
    - (3) require that a Certificate of Appropriateness be obtained from the Commission prior to any material change in appearance of the designated property; and
    - (4) require that the property or district be shown on the Official Zoning Map of the City of Dallas and be kept as a public record to provide notice of such designation.
  - iii) Require Public Hearings: The Commission or the Dallas City Council shall hold a public hearing on any proposed ordinance for the designation of any historic district or property. Notice of the hearing shall be published in at least three (3) consecutive issues in the principal newspaper of local circulation, and written notice of the hearing shall be mailed by the Commission to all owners and occupants of such properties. All such notices shall be published or mailed not less than ten (10) nor more than twenty (20) days prior to the date set for the public hearing. A notice sent via the United States mail to the last-known owner of the property shown on the City tax digest and a notice sent via attention of the occupant shall constitute legal notification to the owner and occupant under this ordinance.
  - iv) Notification of Historic Preservation Division: No less than thirty (30) days prior to making a recommendation on any ordinance designating a property or district as historic, the Commission must submit the report, required in *Subsection 4(a)(3)* above, to the Historic Preservation Division of the Department of Natural Resources.
  - v) Recommendations on Proposed Designations: A recommendation to affirm, modify or withdraw the proposed ordinance for designation shall be made by the Commission within

- fifteen (15) days following the Public Hearing and shall be in the form of a resolution to the Dallas City Council.
- vi) The Dallas City Council Actions on the Commission’s Recommendation: Following receipt of the Commission recommendation, the Dallas City Council may adopt the ordinance as proposed, may adopt the ordinance with any amendments they deem necessary, or reject the ordinance.
  - vii) Notification of Adoption of Ordinance for Designation: Within thirty (30) days following the adoption of the ordinance for designation by the Dallas City Council, the owners and occupants of each designated historic property, and the owners and occupants of each structure, site or work of art located within a designated historic district, shall be given written notification of such designation by the Dallas City Council, which notice shall apprise said owners and occupants of the necessity of obtaining a Certificate of Appropriateness prior to undertaking any material change in appearance of the historic property designated or within the historic district designated. A notice sent via the United States mail to the last-known owner of the property shown on the City tax digest and a notice sent via United States Mail shall constitute legal notification to the owner and occupant under this ordinance.
  - viii) Notification of Other Agencies Regarding Designation: The Commission shall notify all necessary agencies within the City of Dallas of the ordinance for designation.
  - ix) Moratorium on Applications for Alteration or Demolition while Ordinance for Designation is Pending: If an ordinance for designation is being considered, the Commission shall have the power to freeze the status of the involved property.
- 5) Application to Preservation Commission for Certificate of Appropriateness
- a) Approval of Material Change in Appearance in Historic Districts or Involving Historic Properties:
    - i) After the designation by ordinance of a historic property of a historic district, no material change in the appearance of such historic property, or of a contributing or non-contributing building, structure, site or object within such historic district, shall be made or be permitted to be made by the owner or occupant thereof, unless or until the application for a Certificate of Appropriateness has been submitted to and approved by the Commission. A Building Permit shall not be issued without a Certificate of Appropriateness.
  - b) Submission of Plans to Commission:
    - i) An Application for a Certificate of Appropriateness shall be accompanied by such drawings, photographs, plans and documentation as may be required by the Commission.
  - c) Interior Alterations:
    - i) In its review of applications for Certificates of Appropriateness, the Commission shall not consider interior arrangement or use having no effect on exterior architectural features.
  - d) Technical Advice:
    - i) The Commission shall have the power to seek technical advice from outside its members on any application.
  - e) Public Hearings on Applications for Certificates of Appropriateness, Notices, and Right to Be Heard:
    - i) The Commission shall hold a public hearing at which each proposed Certificate of Appropriateness is discussed. Notice of the hearing shall be published in the principal newspaper of local circulation in the city and written notice of the hearing shall be mailed by the Commission to all owners and occupants of the subject property. The written and published notice shall be provided in the same manner and time frame as notices are provided

- before a Public Hearing for Rezoning.
- ii) The Commission shall give the property owner and/or applicant an opportunity to be heard at the Certificate of Appropriateness hearing.
- f) Acceptable Commission Reaction to Applications for Certificate of Appropriateness:
- i) Evaluation Resources: The Commission may evaluate an application for a Certificate of Appropriateness using the *Dallas Design Guidelines for Historic Districts and Sites*, adopted on September 2009; *Dallas Sign Ordinance*; or other historical resource as documented or conveyed.
  - ii) Commission Action: The Commission may approve the Certificate of Appropriateness as proposed, approve the Certificate of Appropriateness with any modifications it deems necessary, or reject it.
    - (1) The Commission shall approve the application and issue a Certificate of Appropriateness if it finds that the proposed material change(s) in the appearance would not have a substantial adverse effect on the aesthetic, historic, or architectural significance and value of the historic property or the historic district. In making this determination, the Commission shall consider, in addition to any other pertinent factors, the following criteria for each of the following acts:
      - (a) Reconstruction, Alteration, New Construction or Renovation: The Commission shall issue Certificates of Appropriateness for the above proposed actions if those actions conform in design, scale, building materials, setback and site features and to the Secretary of Interior’s Standards for Rehabilitation and Guidelines for Rehabilitating Historic Buildings.
      - (b) Relocation: A Decision by the Commission approving or denying a Certificate of Appropriateness for the relocation of a building, structure, or object shall be guided by:
        - (i) the historic character and aesthetic interest the building, structure or object contributes to its present setting.
        - (ii) whether there are definite plans for the area to be vacated and what the effect of those plans on the character of the surrounding area will be.
        - (iii) whether the building, structure or object can be moved without significant damage to its physical integrity.
        - (iv) whether the proposed relocation area is compatible with the historical and architectural character of the building, structure, site or object.
      - (c) Demolition: A decision by the Commission approving or denying a Certificate of Appropriateness for the demolition of buildings, structures, sites, trees judged to be 50 years old or older, or objects shall be guided by:
        - (i) the historic, scenic or architectural significance of the building, structure, site, tree or object.
        - (ii) the importance of the building, structure, site, tree, or object to the ambiance of a district.
        - (iii) the difficulty or the impossibility of reproducing such a building, structure, site, tree, or object because of its design, texture, material, detail, or unique location.

- (iv) whether the building, structure, site, tree, or object is one of the last remaining examples of its kind in the neighborhood or the city.
  - (v) whether there are definite plans for use of the property if the proposed demolition is carried out, and what the effect of those plans on the character of the surrounding area would be.
  - (vi) whether reasonable measures can be taken to save the building, structure, site, tree, or object from collapse.
  - (vii) whether the building, structure, site, tree, or object is capable of earning reasonable economic return on its value.
- g) Undue Hardship:
- i) When, by reason of unusual circumstances, the strict application of any provision of this Ordinance would result in the exceptional practical difficulty or undue economic hardship upon any owner of a specific property, the Commission, in passing upon applications, shall have the power to vary or modify strict provisions, so as to relieve such difficulty or hardship; provided such variances, modifications interpretations shall remain in harmony with the general purpose and intent of said provisions, so that the architectural or historical integrity, or character of the property, shall be conserved and substantial justice done. In granting variances, the commission may impose such reasonable and additional stipulations and conditions as will, in its judgment, best fulfill the purpose of this Ordinance. An undue hardship shall not be a situation of the persons own making.
- h) Deadline for Approval or Rejection of Application for Certificate of Appropriateness:
- i) The Commission shall approve or reject an application for a Certificate of Appropriateness within forty-five (45) days after the filing thereof by the owner or occupant of a historic property, or of a building structure, site, or object located within a historic district. Evidence of approval shall be by a Certificate of Appropriateness issued by the Commission. Notice of the issuance or denial of a Certificate of Appropriateness shall be sent by United States mail to the applicant and all other persons who have requested such notice in writing filed with the Commission.
  - ii) Failure of the Commission to act within said forty-five (45) days shall constitute approval, and no other evidence of approval shall be needed.
- i) Necessary Action to be Taken by Commission upon Rejection of Application for Certificate of Appropriateness:
- i) In the event the Commission rejects an application, it shall state its reasons for doing so, and shall transmit a record of such actions and reasons, in writing, to the applicant. The Commission may suggest alternative courses of action it thinks proper if it disapproves of the application submitted. The applicant, if he or she so desires, may make modifications to the plans and may resubmit the application at any time after doing so.
  - ii) In cases where the application covers a material change in the appearance of a structure which would require the issuance of a building permit, the rejection of the application for a Certificate of Appropriateness by the Commission shall be binding upon the building inspector or other administrative officer charged with issuing building permits and, in such a case, no building permit shall be issued.
  - iii) Requirement of Conformance with Certificate of Appropriateness:  
All work performed pursuant to an issued Certificate of Appropriateness shall conform to the

- requirements of such certificate. In the event work is performed not in accordance with such certificate, the Commission shall issue a cease-and-desist order and all work shall cease.
- i) The Commission and the Dallas City Council shall be authorized to institute any appropriate action or proceeding in a court of competent jurisdiction to prevent any material change in appearance of a designated historic property or historic district, except those changes made in compliance with the provisions of this ordinance or to prevent any illegal act or conduct with respect to such historic property or historic district.
  - i) Certificate of Appropriateness Void if Construction Not Commenced:
    - i) A Certificate of Appropriateness shall become void unless construction is commenced within six (6) months of date of issuance. A Certificate of Appropriateness shall be issued for a period of eighteen (18) months and is renewable.
  - j) Recording an Application for Certificate of Appropriateness:
    - i) The Commission shall keep a public record of all applications for Certificates of Appropriateness, and or all the Commission’s proceedings in connection with said application.
  - k) Acquisition of Property:
    - i) The Commission may, where such action is authorized by the Dallas City Council and is reasonably necessary or appropriate for the preservation of a unique historic property, enter into negotiations with the owner for the acquisition by gift, purchase, exchange, or otherwise, to the property or any interest therein.
  - l) Appeals:
    - i) Any person adversely affected by any determination made by the Commission relative to the issuance or denial of a Certificate of Appropriateness may appeal such determination to the Dallas City Council. Any such appeal must be filed with the Dallas City Council within fifteen (15) days after the issuance of the determination pursuant to *Section 11.11 – Administrative Appeals Procedure* of this Ordinance or, in the case of a failure of the Commission to act, within fifteen (15) days of the expiration of the forty-five (45) day period allowed for the Commission action. Appeals for properties within the City of Dallas shall be made to the Dallas City Council. The Dallas City Council may approve, modify, or reject the determination made by the Commission, if the governing body finds that the Commission abused its discretion in reaching its decision. In order to evaluate an appeal based on an asserted abuse of discretion the Council may but shall not be required to conduct a de novo review of the determination. Appeals from decisions of the Dallas City Council may be taken to the Superior Court of Paulding County in the manner provided by law for appeals from conviction for the City of Dallas ordinance violations.
- 6) Maintenance of Historic Properties and Building and Zoning Code Provisions
- a) Ordinary Maintenance or Repair:
    - i) Ordinary Maintenance or repair of any exterior architectural or environmental feature in or on a historic property to correct deterioration, decay, or to sustain the existing form, and that does not involve a material change in design, material or outer appearance thereof, does not require a Certificate of Appropriateness.
  - b) Failure to Provide Ordinary Maintenance or Repair:
    - i) Property owners of historic properties or properties within historic districts shall not allow their buildings to deteriorate by failing to provide ordinary maintenance or repair. The Commission shall be charged with the following responsibilities regarding deterioration by neglect.
      - (1) The Commission shall monitor the condition of historic properties and existing buildings in historic districts to determine if they are being allowed to deteriorate by neglect. Such

conditions as broken windows, doors and exterior openings which allow the elements and vermin to enter, or the deterioration of a buildings structural system shall constitute failure to provide ordinary maintenance or repair.

- (2) In the event the Commission determines a failure to provide ordinary maintenance or repair, the Commission will notify the owner of the property and set forth the steps which need to be taken to remedy the situation. The owner of such property will have thirty (30) days in which to do this.
  - (3) In the event that the condition is not remedied in thirty (30) days, the owner shall be punished as provided in *Chapter XII: Violations and Enforcement* of this Ordinance and, at the direction of the Dallas City Council; the Commission may perform such maintenance or repair as is necessary to prevent deterioration by neglect. The owner of the property shall be liable for the cost of such maintenance and repair performed by the Commission.
- c) Affirmation of Existing Building and Zoning Codes:
- i) Nothing in this Ordinance shall be constructed as to exempt property owners from complying with existing City building and zoning codes, nor prevent any property owner from making any use of this property not prohibited by other statutes, ordinances or regulations.
- 7) Penalty Provisions
- a) Violations of any provisions of this Ordinance shall be punished in the same manner as provided for punishment of violations of validly enacted Ordinances of the City of Dallas.
- 8) Downtown Dallas Historic District
- a) Purpose.
    - i) In support and furtherance of its findings and determination that the historical, cultural and aesthetic heritage of the city is among its most valued and important assets and that the preservation of this heritage is essential to the promotion of the health, prosperity and general welfare of the people;
    - ii) In order to stimulate revitalization of the business districts and historic neighborhoods and to protect and enhance local historic and aesthetic attractions to tourists and thereby promote and stimulate business;
    - iii) In accordance with the ordinance to establish a Historic Preservation Commission in the city; to provide for the designation of historic properties or historic districts; to provide for issuance of certificates of appropriateness; to provide for an appeals procedure; to repeal conflicting ordinances; and for other purposes; and
    - iv) The Dallas City Council hereby declares it to be the purpose and intent of this article to designate a historic district in a geographically definable area containing buildings, structures, sites, objects, and landscape features or a combination thereof which has special character or special historic/aesthetic value or interest; represents one or more periods, styles, or types of architecture typical of one or more eras in the history of the city, the county, the state, or the region; and causes such area, by reason of such factors, to constitute a visibly perceptible section of the City of Dallas.
  - b) Designation of Historic District and Boundary Description.
    - i) There is hereby created and designated in and for the City of Dallas the Dallas Commercial

Historic District with boundaries as follows: (SEE EXHIBIT “A” ATTACHED HERETO AND IS OF ORD. NO. 2009-10, 8-3-2009 FOR A MORE COMPLETE LEGAL DESCRIPTION)

- c) List of Property in the Historic District and Ownership thereof.
  - i) There is attached a list of property located within the Dallas Commercial Historic District as created in subsection b hereof, and the owner thereof is set forth beside the name of each property (SEE EXHIBIT “B” ATTACHED HERETO AND IS INCORPORATED HEREIN BY REFERENCE FOR PROPERTY IN HISTORIC DISTRICT AND OWNERSHIP THEREOF).
- d) Commercial Historic District Design Guidelines.
  - i) There is created a Commercial Historic District Design Guidelines for the Dallas Commercial Historic District (See Exhibit “C” ATTACHED HERETO AND IS INCORPORATED HEREIN BY REFERENCE FOR DALLAS COMMERCIAL HISTORIC DISTRICT GUIDELINES).
- e) Historic District Boundaries on the Official Zoning Map.
  - i) Upon designation, the Dallas Commercial Historic District shall be shown on the Official Zoning Map of the City of Dallas and kept as a public record to provide notice of such designation.

Figure 10.1: Certificate of Appropriateness Process

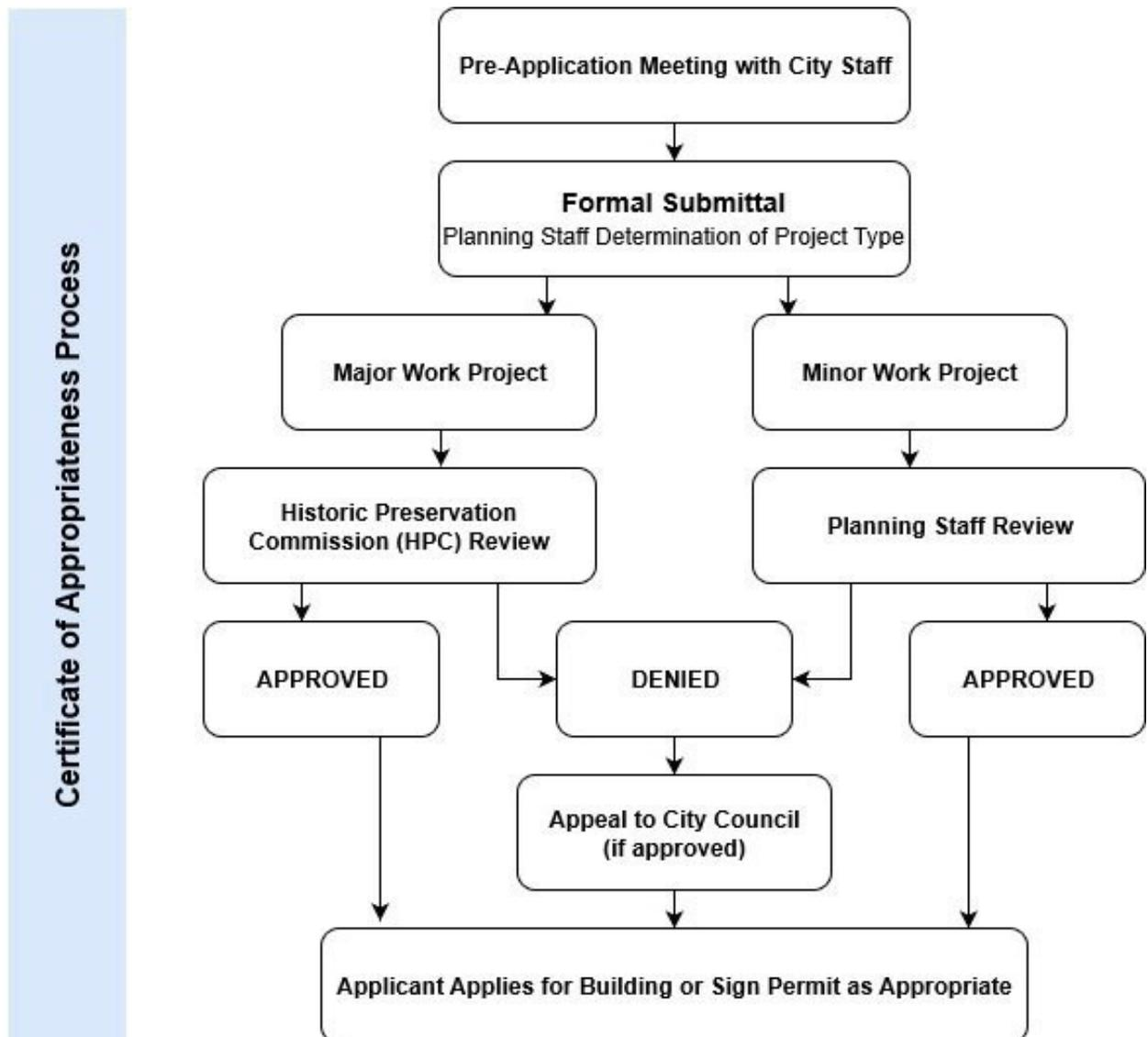

## CHAPTER XI – PETITIONS, PERMITS, AND PROCEDURES

Sec. 11.01 – PURPOSE

---

This chapter contains procedures for processing petitions and permits required for development.

Sec. 11.02 – APPLICATION AND PERMIT TYPES

---

- 1) PETITIONS AND PERMITS. The petitions and permits include:
  - a. Development Plan Approval
  - b. Development Standards Variance
  - c. Special Exception Permit
  - d. Administrative Appeal
  - e. Zoning Map Amendment (“rezoning”)
  - f. Comprehensive Plan Amendments, including amendment to the Future Development Map
  - g. Land Disturbance Permit (note: a building permit may also be required consistent with the provisions of the Dallas Building Code)
  - h. Zoning Compliance Certificate
  - i. Certificate of Occupancy
  - j. Sign Permit
  - k. Sexually Oriented Business Permit
  
- 2) APPLICATION MATERIALS. All applications may be obtained from the Community Development department. Fees shall be paid at the time all petition applications are submitted and at the time all permits are issued as specified in each individual procedure.
  - a. All applications shall be made on forms provided by the Community Development department. Copies, necessary plans, and attachments shall be submitted as required by the adopted policies of the Director and the applicable rules of Procedure, as amended, of the Planning & Zoning Commission, Zoning Board of Appeals, and City Council.
  - b. Scheduling. All applications shall be assigned reference and/or docket numbers by the Director, or designee.
    - i. Petition Applications. Petition applications shall be scheduled by the Director, or designee, for the appropriate public hearings based on the completeness of the application consistent with the requirements of this chapter and the appropriate adopted Calendars of Filing and Meeting dates for the Council and/or Planning & Zoning Commission.
    - ii. Order of Action Taken. Action shall be taken on all applications in the order in which they were received.
  
- 3) FORM. All applications shall be submitted using the appropriate application form per each application type, as specified by the department.
  - i) Review of Application Completeness. Upon submittal, each application shall be subjected to a review of application completeness prior to being officially accepted by the City. A review of application completeness prior review of application completeness prior to being officially accepted by the City. An application shall be considered "complete" if it is submitted on the

required form, includes all submittal information, including all exhibits specified by the Director, and accompanied by the application processing fee as adopted by the City Council and as may be revised periodically. If the city determines that the application is incomplete, City staff shall notify the applicant of that fact via the contact information provided and specify the ways in which the application is deficient. All incomplete applications shall receive no further processing until the deficiencies are corrected via a new submittal. Resubmittal of the application shall be treated as a new application for scheduling purposes.

- a) Submittal Fees. All applications shall be submitted with the required fee. The amount of each fee will be established by the Director, and approved by the City Council which may be revised periodically. Applicants may apply for more than one application simultaneously and such applications may be simultaneously considered by the City as more specifically provided by this chapter. In the case that more than one application is filed simultaneously, the applicant shall be responsible for filing the appropriate information and paying the specified fees for each application filed. All fees are nonrefundable once the application has been determined complete.

### Sec. 11.03 – DEVELOPMENT PLAN REVIEW AND APPROVAL

---

- 1) **PURPOSE.** The purpose of this chapter is to identify a procedure for the review and approval of development plans.
- 2) **APPLICABILITY.** With the exception of a request to rezone, the Development Plan Review process may occur concurrently with any other Planning & Zoning Commission review process. This review shall be completed within the procedures set forth in this section and all other applicable sections of this ordinance.
  - a) Development Plan Review Required. The following list identifies the types of projects that require development plan review:
    - i) New construction and site development for multifamily, commercial, institutional or industrial uses, non-residential subdivision (shopping center or office park), or a project involving a planned unit development (PUD) that does not require a plat.
    - ii) A project where the conversion of a structure to a permitted use is being considered and where no exterior construction or site development is planned. Use conversions requiring Development Plan Review include changes from one of the following categories to another:
      - (1) Residential to commercial or industrial;
      - (2) Commercial to multifamily or industrial;
      - (3) Industrial to multifamily or commercial; and
      - (4) Single or two-family to multifamily or commercial.
    - iii) A project where an existing multifamily, commercial, or industrial use is proposing an addition or expansion of the structure or the site that will have at least one or more of the following effects:
      - (1) Alteration of traffic flows and/or volumes because of changes in ingress or egress or changes within the site;
      - (2) Alteration of on-site parking facilities by more than thirty-five (35%) percent; and
      - (3) Addition to a structure that increases the floor area thirty-five (35%) percent or more of

the existing structure.

- (4) Addition to a structure that increases the floor area thirty-five (35%) percent or more of the existing structure.
    - iv) The construction of public or private off-street parking areas in districts where they are permitted as set forth in this ordinance.
  - b) Director shall have the authority to exempt requirements for a development plan, or exempt the development plan all together, if no physical or minimal change to property or structures on the property is occurring.
- 3) GENERAL STANDARDS OF REVIEW. Development plans shall be reviewed taking into account the following standards:
- a) Compatibility with surrounding land uses.
  - b) Consistency with the Comprehensive Plan.
  - c) Compliance with all applicable requirements of this ordinance.
  - d) Availability of sanitary sewer, water, storm water drainage, and any other utilities as deemed necessary.
  - e) Management of traffic in a manner favorable to the health, safety, convenience, and harmonious development of the community, with particular emphasis on the following factors:
    - i) The design and location of proposed street and highway access points and sidewalks to minimize safety hazards and congestion.
    - ii) The capacity of adjacent existing streets and highways and sidewalks to safely and efficiently handle traffic projected to be generated by the proposed development.
    - iii) The coordination of entrances, streets, sidewalks, and internal traffic circulation facilities in the development plan with existing and planned streets and adjacent developments.
    - iv) Other factors provided for in this ordinance.
- 4) DEVELOPMENT PLAN REVIEW PROCEDURE.
- a) Overview. The Development Plan Review Process consists of five (5) major steps in the following order:
    - i) Preliminary meeting with staff;
    - ii) Submittal of the Conceptual Development Plan and/or Preliminary Plat;
    - iii) Technical Advisory Committee (TAC) review;
    - iv) Community Development Director approval; and
    - v) Submission of the Final Plat which serves as the construction drawings and administrative approval. The Preliminary Plat must always precede the Final Plat process.
  - b) Application and Meeting with Staff. The applicant shall first set up a meeting with staff to discuss submittal of a Preliminary and to obtain a schedule, guidance and requirements for submittal.
  - c) Preliminary Plat Application. The Conceptual Development Plan submittal shall include the following items:

- i) Application Form. This application form, when completed will contain general information including the name and location of the proposed development, as well as the identification of all the property owners, the parcel number (part of or all of the parcel), and must be signed by the property owner(s) or include written authorization for an agent.
- ii) Application Fee. The Conceptual and Final Plat applications must be accompanied by the payment of a fee as established by *Section 11.15 – Fees*. No application will be considered complete unless accompanied by a fee payment. All fees are nonrefundable, regardless of the outcome of the application.
- iii) Application Material Format. All drawings shall be provided in both hard copy and digital format in a manner specified on the application or by the Director.
- iv) Preliminary Plat Contents. The applicant shall submit the required number of copies as specified in the application and the applicant shall follow procedures for distribution of required plans to the Technical Advisory Committee (TAC) members prior to the regularly scheduled meeting. The plat shall include:
  - (1) Proposed name of the project
  - (2) Name, address, phone number, and email of the owner, the developer and the designer who prepared the plat.
  - (3) Miscellaneous. North point and graphic scale, source of data, date of plan drawing, and, if any, revision dates
  - (4) An accurate, up-to-date and certified survey of the property on which the project is to be built. Date of boundary survey must be included on plat
  - (5) Location and size of the property in acres (or in square feet if less than an acre), and the external boundaries of the tract to be subdivided or developed shown by bearings and distances
  - (6) Vicinity map
  - (7) Abutting property information. Names of adjoining property owners per recorded deeds, zoning district, use, and overlay district if applicable
  - (8) Prior subdivision (if any)
  - (9) Zoning and overlay district (if applicable) of property with required setbacks shown
  - (10) Topography at 2-foot intervals
  - (11) Natural features and flood plains. Natural features within the property, including topographic contours at no less than five-foot intervals, drainage channels, bodies of water, wetlands, streams with required buffer designated, wooded areas and other significant natural features such as groundwater recharge areas and rock outcroppings. On all water courses entering or leaving the property, the direction of flow shall be indicated. The 100-year flood plain, if any, shall be delineated
  - (12) Streets, easements, political boundaries and built features. Man-made features within and adjacent to the property, including street right-of-way and pavement widths, names of existing streets, all easements, city and county political boundary lines, and other significant information such as location and dimensions of bridges, existing buildings to remain, and other features
  - (13) Subdivision block and lot layout. The proposed subdivision layout including lot lines and street right-of-way lines, with proposed street names or letter designations and right-of-way widths, along with the front building setback line and the approximate dimensions of the length and width of each lot. The total number of lots in the subdivision and the total

- acreage in the tract to be subdivided shall be indicated. Lots shall be numbered consecutively in a clockwise fashion, and the approximate land area of each lot shall be indicated for each lot. The proposed phasing of the subdivision shall be indicated, if it is proposed to be platted in phases
- (14) Proposed site layout including buildings, drives, parking, walkways, landscaped areas, buffer easements, utilities and any other features necessary to properly present the concept.
  - (15) Proposed off-site improvements which may be necessary to properly develop site.
  - (16) Architectural elevations to show the intended architectural character of the proposed building and the nature of the materials to be used.
  - (17) If the site plan is for an addition to or change in an existing site plan, the drawings must clearly show the changes that are being proposed.
  - (18) Storm water management. The approximate location of proposed storm water detention facilities
  - (19) Public land reservations. In addition to public streets, the preliminary plat shall indicate land if any to be dedicated for public use.
  - (20) Provide vehicular use area landscaping requirements.
  - (21) Other information as may be required by the City Engineer and Community Development Director.
- v) Special Studies Required. In the event that the Community Development Director feels that additional information is necessary in order to make its decision, it may instruct the applicant or City Staff to conduct additional studies or seek expert advice. The cost of such studies shall be the responsibility of the applicant.
- (1) Transportation Impact Studies. If a traffic study is necessary, it shall address the impact of the proposed development on all adjacent streets and intersections. The applicant shall reference the *Georgia Department of Transportation Design Traffic Forecasting Manual, Revision 1.4*, as may be amended from time to time in the development of the traffic study.
  - (2) Fiscal Impact Analysis. New residential development of more than one-hundred fifty (150) units shall be required to submit a Fiscal Impact Analysis to determine the impact of new residents on the area with regard to police protection, fire protection, utility service, educational facilities, and other applicable factors.
  - (3) Any necessary approval by federal, state, or other local agencies shall be included on their official forms and signed by the proper authority. These approvals may include, but are not limited to the following:
    - (a) Federal Agencies
      - (i) Federal Communications Commission
      - (ii) Federal Aviation Administration
      - (iii) Federal Emergency Management Agency
      - (iv) Army Corps of Engineers
      - (v) Environmental Protection Agency
    - (b) State Agencies
      - (i) Georgia Environmental Protection Division
      - (ii) Georgia Department of Natural Resources
      - (iii) Georgia Department of Transportation

- (iv) Georgia State Department of Health
  - (c) Local Agencies
    - (i) County Fire Rescue
    - (ii) County Health Department
    - (iii) County Department of Transportation
  - (d) Utility Companies
    - (i) Public or private utilities for power, sanitary sewer or water services
- vi) If applicable, include a letter of intent indicating that the applicant wishes to construct a model home prior to recording. The letter of intent must include the proposed lot number on which the model home will be constructed. A maximum of five (5) model homes may be permitted per development for single-family residential development and a maximum of four (4) units per multifamily development and a Certificate of Occupancy will not be issued for the model home until the subdivision or section thereof has been properly recorded. Certain necessary improvements may be required of the developer prior to issuance of the building permit.
- d) Technical Advisory Committee (TAC) Review. Once the submittal for the conceptual development plan is deemed complete, the applicant shall appear at the regularly scheduled Technical Advisory Committee (TAC) to discuss the proposed project and receive comments from several City departments on the proposed project. The TAC shall review the Preliminary Plan to determine if it is:
  - i) Consistent with the intent and purpose of this ordinance;
  - ii) Whether the proposed development advances the general welfare of the community and neighborhood; and
  - iii) Whether the benefits, combination of various land uses, and the interrelationship with the land uses in the surrounding area justify the deviation from standard district regulations.
  - iv) The TAC shall prepare a summary of project compliance with the ordinance for review by the Community Development Director.
- e) Review by the Community Development Director.
  - i) Possible Action. The Community Development Director shall approve, approve with modifications, deny, or continue the Development Plan application.
    - (1) The Community Development Director may impose conditions on the approval of a Development Plan if the conditions are necessary to satisfy the requirements and intent of this ordinance. Accepted conditions shall become written commitments which shall be recorded by the applicant before any construction activity commences.
- f) Final Plat Submittal. The Community Development Director's approval of the Conceptual Development Plan shall be necessary before an applicant may obtain a Final Plat approval. The Director and the Technical Advisory Committee shall be responsible for review of the Final Plat (construction drawings) submittal which shall include the following items:
  - i) General vicinity map;
  - ii) Property boundary lines including any easements and a legal description;
  - iii) Elevation marks and contours as appropriate;
  - iv) Benchmarks;

- v) Traffic and circulation plan;
- vi) Pedestrian circulation plan or trail plan, if applicable.
- vii) Adjacent streets;
- viii) Parking and loading plan in accordance with *Section 7.02 – Off-Street Parking and Loading*;
- ix) Utilities plan showing existing and proposed location and sizes;
- x) Landscape plan indicating plant types, number, location, size and method of installation and in accordance with *Section 7.05 – Landscaping Standards*;
- xi) Grading and surface drainage plan in accordance with the requirements of the Subdivision Control ordinance and the Stormwater ordinance;
- xii) Signage plan showing location, sign faces, representations, and size in accordance with the *Dallas Sign Ordinance*;
- xiii) Final lighting plan in accordance with *Section 7.12 – Outdoor Lighting*;
- xiv) Open space and recreation plan;
- xv) Refuse/trash storage areas;
- xvi) Proposed improvements showing location, dimensions and configuration of existing and proposed buildings/structures and uses.
- xvii) Architectural Plan. The applicant must submit one (1) copy of an architectural plan of the proposed project showing exterior elevations, floor plans and building materials used (facade and roof). If exterior elevations are not available, reasonable graphic representations may be submitted;
- xviii) A State Plan release is also required for multifamily, residential and non-residential (commercial and industrial) projects. In no way will a Development Plan review be construed as a substitute or a waiver for these other required permits.
- xix) Plat-like Dedication Sheet, if necessary. The following information shall be submitted for easements and rights-of-way if deemed necessary by the Community Development Director or his/her authorized designee:
  - (1) Parcels of land proposed to be dedicated or reserved for public use, or reserved for common use of all property owners within the project, with the proposed conditions and maintenance requirements, if any, shall be designated as such and clearly labeled on the plans;
  - (2) Radii, internal angles, points of curvature; tangent bearings and lengths of all arcs, chord, and chord bearings; and
  - (3) Accurate location of all survey monuments erected, corners and other points established in the field in their proper places;
- xx) The schedule of any phasing of the project; and
- xxi) A development summary indicating lot area, building square footage, lot coverage, building height, size of dwelling units/structures, area of hard surface provided, and the number of parking spaces required and provided;
- xxii) All drawings prepared for submission under this section must be prepared by a professional engineer, architect, or surveyor and must bear a professional seal from the State of Georgia.

- If, however, the Director determines that due to the simplicity of the project, a professional seal may not be required, then this requirement may be waived.
- g) Approval. After review of the Final Plat, the Director and the Technical Advisory Committee shall approve or deny the Final Plat. The Final Plat may be appealed to the Zoning Board of Appeals. An applicant shall have two (2) years from the date of approval to obtain a Land Disturbance Permit/Building Permit. This permit must be obtained in accordance with *Section 11.12 – Land Disturbance Permit*. Should this two (2) year period elapse without the applicant having obtained the appropriate permit, the Development Plan approval will become null and void. Should this become the case, the applicant may resubmit the application in conformance with the requirements of this chapter.
- h) Any performance guarantee submitted under this section shall be for a period not to exceed two (2) years. The Council may grant an extension of up to one (1) year for the completion of the improvements, based upon a request by the developer and evidence justifying the request. The Council may secure a new estimate of the cost of the improvements from the City Engineer. If the estimate has increased, the Council shall require an increase in the amount of the performance guarantee.
- 5) A performance guarantee shall be deemed by the Council to be in full force and effect until the time the guarantee is released by written notice by the Council.
- a) It shall be the responsibility of the developer to keep the performance guarantee current and not allow it to expire until all improvements have been accepted by the Council. If the performance guarantee does expire, no building permits will be issued to those lots within the subdivision or section thereof which required the performance guarantee until a new guarantee is provided. Upon completion of the improvements for which a performance guarantee has been provided, the developer shall request a release of the performance guarantee from the Dallas Community Development department. The Community Development department will conduct an inspection of the completed improvements. If the improvements have been completed to the satisfaction of the Community Development department and if a suitable maintenance guarantee has been provided, then the Council shall release the performance guarantee. Appeals of Dallas Community Development department decisions shall be made to the City Council.
- b) As a condition of acceptance of this improvement on release of the performance guarantee, the Council shall require the developer to post a maintenance guarantee in an amount equal to twenty-five (25%) percent of the cost of the improvements.
- i) The maintenance guarantee shall be one (1) of the following forms:
- (1) Maintenance Bond. This bond shall comply with all statutory requirements and shall be satisfactory to the City Attorney as to form, sufficiency and manner of execution; or
  - (2) Irrevocable Letter of Credit. In lieu of such bond, the developer may submit an Irrevocable Letter of Credit. In the event an Irrevocable Letter of Credit is used, it shall be written for a minimum length of one (1) year.
- ii) The maintenance guarantee shall be for a period of three (3) years.
- 6) CONFORMANCE WITH DEVELOPMENT PLAN APPROVAL. The Community Development Director may consider the revocation of a Development Plan approval in the event that a proposed development, which occupancy permit has not been issued, is found to be in violation of the requirements of this ordinance for the conditions attached to the approval by the Director. Should revocation be

considered, the Community Development Director must schedule a meeting in which to consider the revocation and shall notify the original applicant or project representative of the date, time and place of the hearing at least fifteen (15) days in advance of the meeting by certified mail. In the event that the Community Development Director decides to revoke approval, the occupancy permit may not be issued until the Director certifies that the violation has been corrected. Where a violation involves a project where an occupancy permit has been issued, the violation shall be treated as a violation to this ordinance and be subject to the penalty as specified in *Chapter XII: Violations and Enforcement*.

- 7) STAGED DEVELOPMENT. Where a proposed Development Plan indicates a staged site development approach, the later stages of the proposed development may be constructed within ten (10) years of the initial approval providing that the initial stage is completed in conformance with the Development Plan and that the application commenced shall be subject to the application and review requirements stated within this chapter and any additional amendments.

Figure 11.01: Preliminary and Final Plat Flow Chart

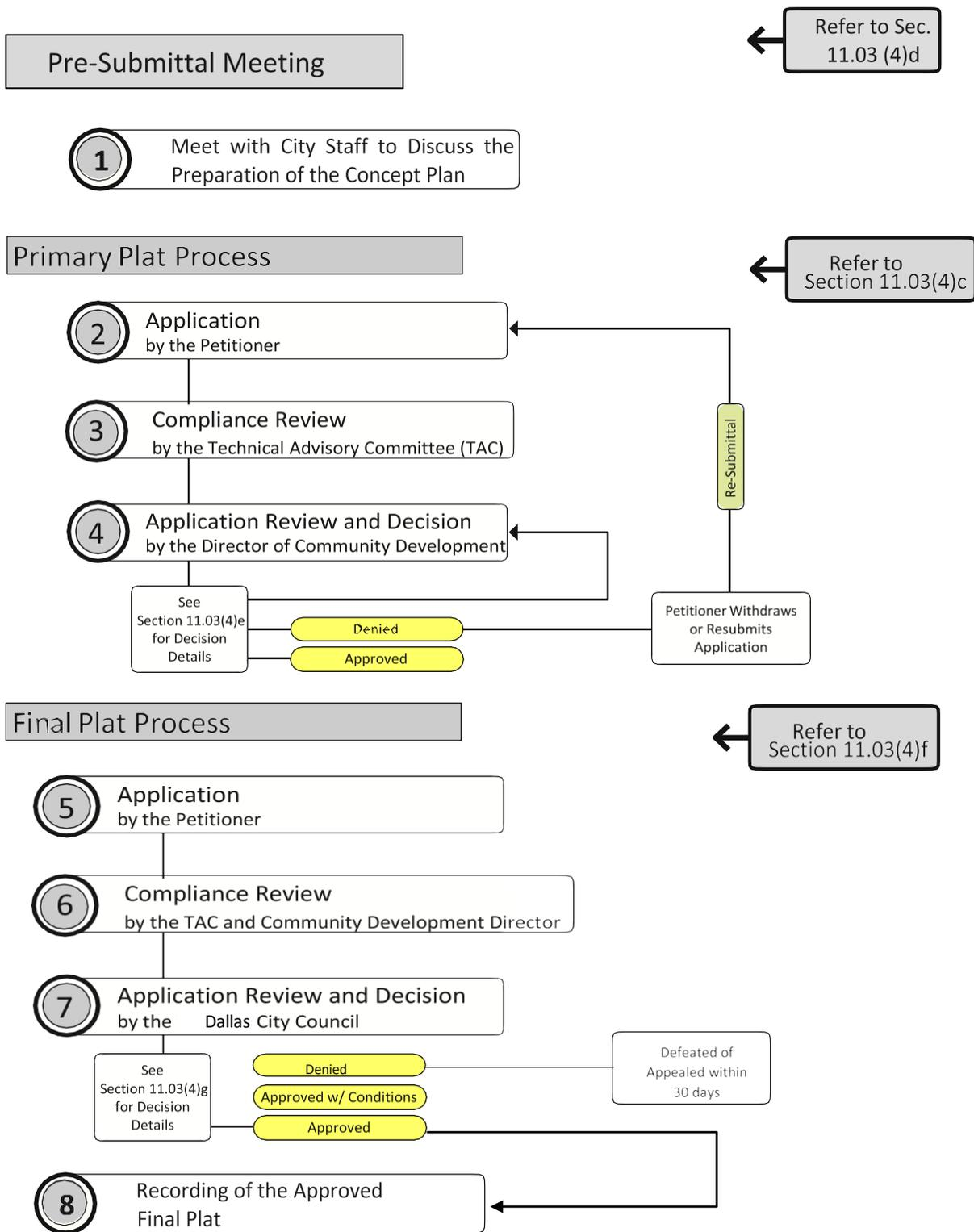

\* If denied by the TAC, an appeal can be made to the City Council per Section 11.11.

**Sec. 11.04 – WRITTEN COMMITMENTS**

---

- 1) Rules Governing Commitments. In accordance with the *Georgia Planning Act (O.C.G.A. 45-12-200, et seq., and 50-8-1, et seq.)*, during the time when a proposal is being considered by the Planning & Zoning Commission or the City Council, the owner of a parcel of land may make a new Commitment or modify the terms of a Commitment made when the proposal was before the Planning & Zoning Commission or City Council. No further action of the Planning & Zoning Commission or Council is required for a new Commitment to be effective. If a Commitment made when the proposal was before the area Planning & Zoning Commission or Council is modified and the effect of the modification is to make the Commitment more stringent, no further action of the Planning & Zoning Commission or Council is required for the modified Commitment to be effective; however, if the effect of such a modification is to make the Commitment less stringent, then the modified Commitment must be ratified by the Planning & Zoning Commission or Council to be effective. A Commitment made or modified under this provision is subject to the following rules:
  - a) Form. A commitment shall be documented on a Planning & Zoning Commission-approved Commitment Recording Form.
  - b) Recording, Copies. A Commitment shall be signed by the applicant and be recorded by the Community Development department in the office of the Paulding County recorder. It shall take effect upon the adoption of the proposal to which it relates within thirty (30) days of approval.
  - c) Persons Bound. Unless it is modified or terminated by the area Planning & Zoning Commission or Council in accordance with *Subsection 11.04(1)(e)* below, a recorded Commitment is binding on the owner of the parcel, a subsequent owner of the parcel, and any other person who acquires an interest in the parcel. An unrecorded Commitment is binding on the owner of the parcel who makes the Commitment. an unrecorded Commitment is binding on a subsequent owner of the parcel or a person acquiring an interest in the parcel only if the subsequent owner or person acquiring the interest has actual notice of the Commitment.
  - d) Enforcement. Refer to *Section 12.02 – Zoning Violations*.
  - e) A commitment automatically terminates if the zoning map applicable to the parcel which the commitment relates is changed.
  - f) Modification or Termination by Commission or Council. Except for a commitment automatically terminated under *Subsection 11.04(1)(e)*, a Commitment may be modified or terminated only by a decision of the Planning & Zoning Commission or City Council made at a public hearing after notice of the hearing has been given under the Planning & Zoning Commission’s or City Council rules of Procedure, as amended.
  - g) During the time a rezoning proposal is being considered by the City Council, the applicant may make a new commitment or modify the terms of a commitment that was made when the proposal was being considered by the Planning & Zoning Commission.

**Sec. 11.05 – ZONING AND FUTURE DEVELOPMENT MAP AND TEXT AMENDMENTS**

---

- 1) TEXT AMENDMENTS. The following procedure, in accordance with the *Georgia Planning Act (O.C.G.A. 45-12-200, et seq., and 50-8-1, et seq.)*, applies to a proposal to amend or partially repeal the text of the Zoning Ordinance:
  - a) Initiation of Proposal. The proposal may be initiated by either:

- i) The City Council; or
  - ii) The Planning & Zoning Commission.
- b) Contents of Application. Applications for text amendments to the Zoning Ordinance shall contain the following information:
- i) Name, address, and phone number of applicant;
  - ii) Proposed amending ordinance, approved as to form by the City Attorney;
  - iii) A statement on how the proposed amendment relates to the comprehensive plan; and
  - iv) A fee as established by the City Council.
- c) Notice. The Planning & Zoning Commission shall give notice of a public hearing in accordance with the Planning & Zoning Commission Rules of Procedure, as amended.
- d) Public Hearing by Planning & Zoning Commission. The Planning & Zoning Commission shall schedule a public hearing within sixty (60) days after a petition is received. The hearing shall be held in accordance with the Planning & Zoning Commission Rules of Procedure, as amended.
- e) Recommendation by Planning & Zoning Commission. Within ten (10) business days after the Planning & Zoning Commission determines its recommendation, the Commission shall certify the proposal to the City Council with a favorable, unfavorable, or no recommendation (*O.C.G.A. 50-8-1*).
- f) Action by City Council. The City Council shall vote on the proposal within ninety (90) days after the Planning & Zoning Commission certifies their recommendation. The City Council may adopt, deny, or recommend a modification of the text amendment proposal. If a modification is recommended, the proposal must be returned to the Planning & Zoning Commission for a final vote of approval. If the modification is disapproved by the Planning & Zoning Commission, the proposal with modification may be adopted only after a final confirming vote by the City Council (*O.C.G.A. § 36-66-3*).
- g) Effective Date and Referendum. Amendments adopted by the City Council shall become effective upon adoption.

## 2) ZONING MAP AND FUTURE DEVELOPMENT MAP AMENDMENTS

- a) General. Whenever the public necessity, convenience, general welfare, or good zoning practices require, the City Council may, by ordinance, after receipt of recommendation from the Planning & Zoning Commission, and subject to the procedures provided by law, amend, supplement, change or repeal the regulations, restrictions, and boundaries or classification of property.
- b) Consideration of Amendments. in accordance with *O.C.G.A. 45-12-200, et seq., and 50-8-1*, when preparing and considering proposed amendments, the Planning & Zoning Commission and the legislative body shall pay reasonable regard to:
  - i) The Comprehensive Plan;
  - ii) Current conditions and the character of current structures and uses in each district;
  - iii) The most desirable use for which the land in each district is adapted;
  - iv) The conservation of property values throughout the jurisdiction; and
  - v) Responsible development and growth.
- c) Procedure. The following procedure, in accordance with *O.C.G.A. 36-66-1*, applies to a proposal

to change the zone maps (whether by incorporating an additional map or by amending or deleting a map) incorporated by reference into the ordinance:

- i) Initiation of Proposal. The proposal may be initiated either:
  - (1) By the City Council;
  - (2) By the Planning & Zoning Commission; or
  - (3) By a petition signed by property owners who own at least fifty (50%) percent or more of the land involved.
- ii) Contents of Application. Applications for amendments to the Official Zoning Map adopted as part of the Zoning Ordinance shall contain the following information:
  - (1) Name, address, and phone number of applicant;
  - (2) Proposed amending ordinance, approved as to form by the City attorney;
  - (3) Present use;
  - (4) Present zoning classification;
  - (5) Proposed use;
  - (6) Proposed zoning classification;
  - (7) A vicinity map showing property lines, thoroughfares, existing and proposed zoning, and such other items as may be required;
  - (8) A parcel map and list identifying all property owners and their mailing addresses;
  - (9) A statement on how the proposed amendment relates to the comprehensive plan;
  - (10) A fee as established by the City Council; and
  - (11) Signature of property owner(s) or agent.
  - (12) Elevation Drawings (may be waived by the Community Development Director);
  - (13) Site Plan;
- iii) Additional Information. At the discretion of the Planning & Zoning Commission, the applicant may be required to provide additional information or studies to demonstrate the impact that will occur as a result of the proposed development associated with the amendment (rezoning) in question. The additional information may include:
  - (1) Transportation Impact Studies. If a traffic study is necessary, it shall address the impact of the proposed development on all adjacent streets and intersections. The applicant shall reference the *GDOT "Design Traffic Forecasting Manual, Revision 1.4", dated 10/24/2018*, as may be amended from time to time in the development of the traffic study.
  - (2) Fiscal Impact Analysis. New residential development of more than one-hundred fifty (150) units may be required to submit a Fiscal Impact Analysis to determine the impact of new residents on the area with regard to police protection, fire protection, utility service, educational facilities, and other applicable factors.
- iv) Notice. The Planning & Zoning Commission shall give notice of a public hearing in accordance with Georgia's Zoning Procedures Act (O.C.G.A 36-66) and the Planning & Zoning Commission Rules of Procedure, as amended.
- v) Public Hearing by Planning & Zoning Commission. The Planning & Zoning Commission shall schedule a public hearing within sixty (60) days after a petition is received. The hearing shall

- be held in accordance with the Planning & Zoning Commission Rules of Procedure, as amended.
- vi) Recommendation by Planning & Zoning Commission. Within ten (10) business days after the Planning & Zoning Commission determines its recommendation, the Commission shall certify the proposal to the City Council with a favorable, unfavorable, or no recommendation (*O.C.G.A. § 50-8-1*).
  - vii) Action by City Council. The City Council shall, within ninety (90) days after the Planning & Zoning Commission certifies their recommendation, either adopt or deny the recommendation of the Planning & Zoning Commission (*O.C.G.A. § 36-66-1*).
  - viii) Effective Date and Referendum. Amendments adopted by the City Council shall become effective upon adoption.
- d) Lapse of Rezoning. Failure to establish the proposed use or initiate development within one (1) year of the rezoning approval or other time period established by the City Council at the time of the rezoning shall constitute consent by the property owner for the City to initiate the process to revert the zoning through the zoning map amendment process established in this Code. The City Council, at its sole discretion may choose to revert the zoning, retain the existing zoning or grant a limited extension of the zoning for lapsed uses.
- e) Lapse of Zoning Conditions. Should a use for which conditions of zoning or a special exception be discontinued or abandoned for twelve (12) months or more, said conditions of zoning or special exception shall be revoked. The City Council, at its sole discretion may choose to revert, retain, or grant a limited extension of the zoning conditions or special exception for lapsed uses. All conditions imposed on an application are transferrable and bind any future owner, developer, builder, applicant of the parcel. All conditions shall be recorded in the county recorder's office prior to preliminary plat approval.

Figure 11.2: Zoning Process Flow Chart

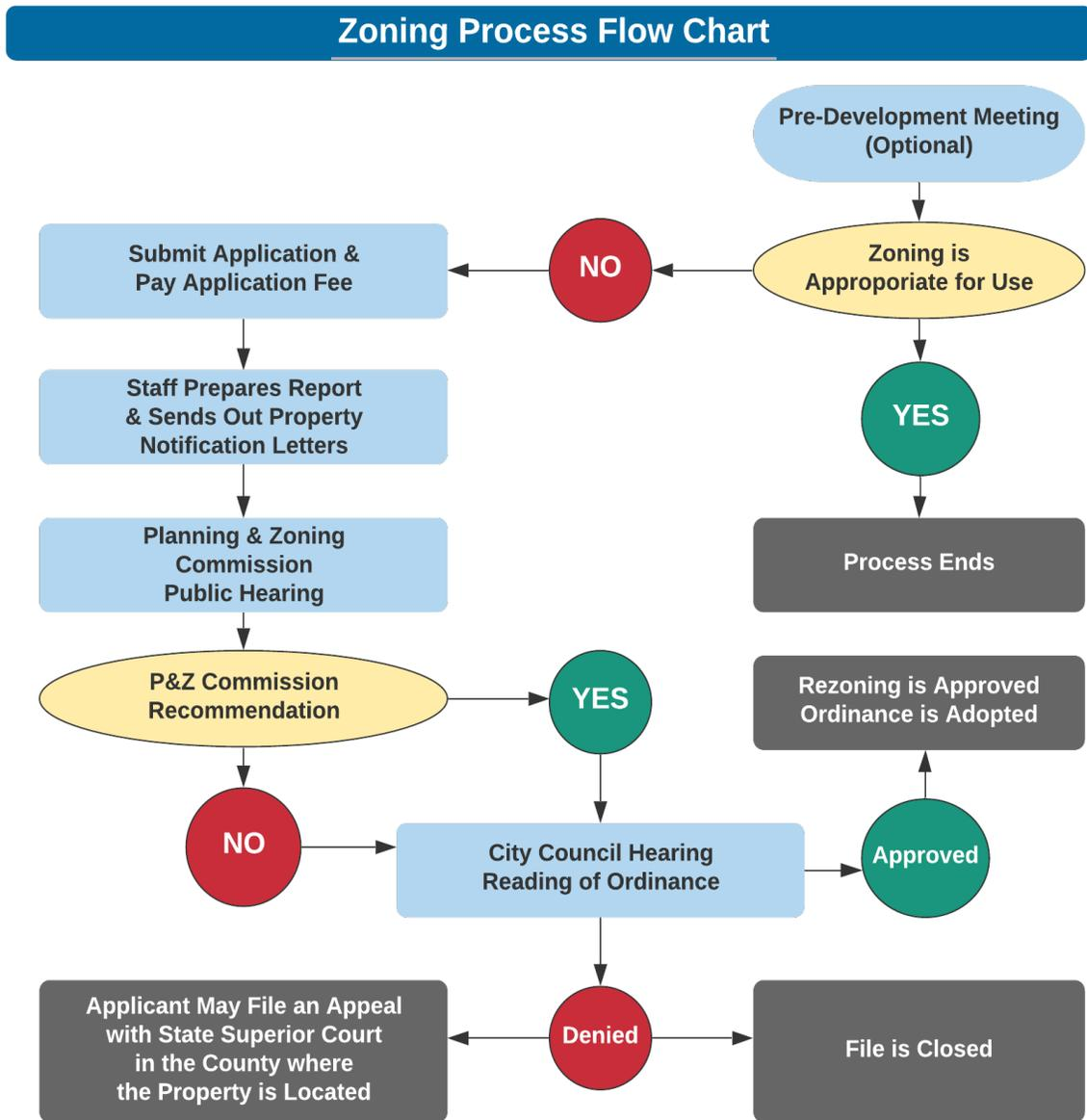

**Sec. 11.06 – DEVELOPMENT STANDARDS VARIANCE**

---

- 1) **DEPENDENT ON ZONING BOARD OF APPEALS APPROVAL.** In no case shall any variance to the terms of this ordinance be authorized without the approval of the Zoning Board of Appeals (ZBA). Further, no decisions on previous applications shall serve to set a precedent for any other application before the ZBA. The procedure within this section shall apply to all variance applications.
- 2) **APPLICATION.** The applicant shall submit a complete variance application, affidavit and consent of property owner (if the owner is someone other than the applicant), the required filing fee, and required supporting information. Supporting information shall include, but not be limited to, the following:
  - a) **Plot or Development Plan.** A plot plan, as described in *Subsection 11.12(3)*, or a Development Plan prepared in accordance with the procedures set forth in *Section 11.03 – Development Plan Review and Approval* and including such other information as the ZBA may be required to determine if the proposed variance request meets the intent and requirements of this ordinance.
  - b) **Letter of Intent.** A letter of intent to the ZBA describing the details of the variance request including but not limited to:
    - i) The ways in which the variance shall be consistent with the intent of the applicable section(s) of the Zoning Ordinance; and
    - ii) Any written commitments being made by the petitioner.
  - c) Such other information as may be required by the ZBA.
  - d) A fee as established by ordinance.
- 3) **PUBLIC NOTICE AND PUBLIC HEARING BY THE ZBA.** Notice of and procedures pertaining to the Public Hearing by the ZBA shall be in conformance with the procedures set forth in the ZBA rules of Procedure, as amended, and *O.C.G.A. § 36-66-4*.
- 4) **DECISION CRITERIA.** In taking action on all variance requests, the Council shall use the following decision criteria, consistent with the requirements of the Georgia Code.
  - a) **Development Standards Variance.** The Council may grant a variance from the standards of this ordinance if, after a public hearing, it makes a determination in writing (consistent with *O.C.G.A. 36-66-1*), that:
    - i) **General Welfare.** The approval will not be injurious to the public health, safety, morals, and general welfare of the community;
    - ii) **Adjacent Property.** The use and value of the area adjacent to the property included in the variance will not be affected in a substantially adverse manner; and
    - iii) **Practical Difficulty.** The strict application of the terms of this ordinance will result in a practical difficulty in the use of the property. This situation shall not be self-imposed, nor be based on a perceived reduction of, or restriction on, economic gain.
- 5) **CONDITIONS.** The Council may impose such reasonable conditions upon its approval as it deems necessary.

- 6) COMMITMENTS. The Council may require the owner of the property to make written commitments concerning the use or development of the property. Such commitments shall be recorded in the County recorder's office. A copy of the recorded commitments shall be provided to the Director for inclusion in the petition file at the time of application for a Land Disturbance Permit. No Land Disturbance Permit shall be issued for a permit application which does not comply with the recorded commitments.

#### **Sec. 11.07 – ADMINISTRATIVE PLATS AND MINOR SUBDIVISIONS**

---

##### 1) MINOR SUBDIVISION

- a) Those subdivisions meeting the definition of "SUBDIVISION, MINOR", contained in this ordinance may be considered under the provisions of this section. Re-subdivisions meeting the conditions of eligibility contained herein also may be considered under the provisions of this Chapter. After a subdivision request has been filed, the Community Development Director shall determine whether the petition may be considered as a minor subdivision. The Director's decision may be appealed to the Planning Commission. Minor subdivisions shall receive approval by the In-house Plat Committee.
- b) Conditions of Eligibility -- Before determining that a subdivision is eligible to be considered under this Article, the Community Development Director shall find that all of the following criteria are satisfied:
- i) Orderly Development – The subdivision will not impede orderly development of land or the provision of public services and improvements.
  - ii) Comprehensive Plan – The subdivision will be consistent with the Comprehensive Plan.
  - iii) Streets – The subdivision will not interfere with the provision of streets to provide access to adjoining or nearby property in the event that such property is developed in the future.
  - iv) Utilities and Drainage – All parcels in the subdivision will have adequate utilities and drainage.
    - (1) Sewage – All lots shall be served by public sanitary sewer system
    - (2) Water – All lots shall be served by a public or quasi-public water system or shall have the capability to contain a well that complies with all requirements of the Georgia Department of Public Health and/or the Paulding County Health Department.
    - (3) Drainage – All lots shall be provided with drainage improvements as necessary to comply with the requirements of Georgia Department of Natural Resources, Environmental Protection Division and the Dallas Unified Development Code.
  - v) Access – All parcels in the subdivision and adjacent land will have adequate ingress and egress without the construction of any new streets or substantial improvement to existing streets.
    - (1) Legal Access -- All lots will have legal access to the City of Dallas, or has been continuously maintained for a period of ten (10) years immediately preceding the filing of the subdivision, by a public agency regularly having responsibility for such maintenance. Such public street shall have a hard surface suitable for vehicular traffic which is at least sixteen (16) feet in width, is in good repair, and has a geometry which is suitable for the traffic which it will carry after the proposed subdivision.

- (2) Driveway Permit – If any lot in a subdivision is to receive access from a State highway, in addition to a waiver from Access Limited the applicant must obtain a driveway permit from the Georgia Department of Transportation.
  - (a) Access Limited – Individual lots in residential subdivisions shall not have driveway access from an arterial or collector road.
- (3) Limited Access Streets – Frontage on limited access streets on which driveways cannot open shall not constitute legal access.
- (4) New Street – If by reason of topography, natural or man-made features, or other conditions relating to the property requested for subdivision, better access can be provided through construction of a new street, the petition shall be considered as a major subdivision.
- (5) Driveway Standards – All lots will have driveway locations that will provide for adequate sight distance and will be properly spaced according to city standards.
- vi) Suitability – All lots in the subdivision will provide suitable building sites for the purpose for which the land is to be used. Land suitability shall be determined by the criteria contained in this ordinance.
- vii) Endangerment – The subdivision will not be detrimental to nor endanger the public health, safety, or general welfare.

## 2) EXPIRATION OF APPROVAL

- a) Approval for a minor subdivision shall be valid for two years from the date of approval, unless an extension is granted by the In-house Plat Committee or the Planning Commission. If not granted before the expiration of two years, the approval shall be null and void.

## 3) MINOR RESIDENTIAL SUBDIVISION

- a) Those subdivision meeting the definition of “SUBDIVISION, MINOR RESIDENTIAL”, contained in this ordinance contained in this ordinance may be considered under the provisions of this section. After a subdivision request has been filed, the Community Development Director shall determine whether the petition may be considered as a minor residential subdivision. The Director’s decision may be appealed to the Planning Commission. Minor residential subdivisions typically receive approval by the In-house Plat Committee, but could be forwarded to the Planning Commission by staff or the Plat Committee.
- b) Conditions of Eligibility – Before determining that an application is eligible to be considered as a minor residential subdivision, the Community Development Director shall find that all of the following criteria are satisfied:
  - i) Orderly Development – The subdivision will not impede orderly development of land or the provision of public services and improvements.
  - ii) Comprehensive Plan – The subdivision will be consistent with the Comprehensive Plan.
  - iii) Suitability – The lot will provide a suitable residential building site. Land suitability shall be determined by the criteria contained in this ordinance.
  - iv) Endangerment – The subdivision will not be detrimental to nor endanger the public health, safety, or general welfare.
  - v) Residential Zoning – Property must be zoned to allow residential development as a permitted use.
  - vi) Minimum Frontage and Acreage Requirements – All lots shall meet the minimum road frontage

- and acreage requirements listed in the zoning ordinance.
- vii) Drainage – Corrective measures for drainage concerns of the site;
  - viii) Sewage and Water – Proof that sewage disposal is acceptable to the Dallas Public Works Department and that a safe water source exists;
  - ix) Right-of-way – Right-of-way dedication pursuant to the Paulding County Transportation Master Plan or Unified Development Code where appropriate;
  - x) Shoulder – A seven (7) foot shoulder and adequate roadside ditch; and
  - xi) Sidewalks – Commitment to participate in the installation of sidewalks across the frontage of the tract whenever sidewalks adjoin the tract.
  - xii) Additional Requirements for an Unimproved Lot – An unimproved lot shall meet the following additional standards:
    - (1) Site Distance – Proper sight distance at the proposed driveway location.
    - (2) Perimeter Drain – Adequate drainage outlet for the septic system subsurface perimeter drain.
- c) Limit of One Minor Residential Subdivision Plat – Only one (1) minor residential subdivision plat, containing one (1) lot, may be created from a parent tract. Creating any additional lots from the same parent tract will require either a major or minor plat, as determined by the Community Development Director or TAC Committee, based on the standards of the Dallas Zoning Ordinance and Unified Development Code.
- 4) SUBMITTAL REQUIREMENTS.
- 5) One (1) copy of the application materials and five (5) copies of the plans must be submitted to the Dallas Community Development Department.
  - 6) Application Materials
    - a) The application materials shall include the following:
    - b) Application
    - c) Copy of the parent tract deed
    - d) Fee
    - e) Subdivision Plat Drawing
    - f) Drainage Narrative/Calculations
  - 7) Subdivision Plat Drawing – The subdivision plat drawing for a minor residential subdivision shall include the following:
    - a) Lot Number
    - b) North Arrow
    - c) Graphical Scale
    - d) Parent tract (drawn from the deed) and labeled as “remainder”
    - e) Proposed Lot including the following:
      - i) Boundary lines and acreage thereof, based upon an accurate traverse
      - ii) Right-of-way
      - iii) Building setback lines
      - iv) All easements and property address
    - f) Section Corners monumentation found and tied to the subject tract
    - g) Cross-reference to a recorded survey per *OCGA § 43-15-1 – Professional Engineers and Land Surveyors*.

- h) Legal Description
  - i) Certificate of dedication
  - j) Certificate of ownership
  - k) Surveyors certification
  - l) Certificate of the Planning Commission (where required) including signature location for the Director or the Community Development Department
  - m) Street classification
  - n) Sidewalk commitment (if applicable)
  - o) Legal drain statement – The following statement shall be placed on the plot plan:
    - i) “This Minor Residential Subdivision application has been filed with the Dallas Department of Community Redevelopment requesting approval of a residential lot created from the parent tract. This lot may be within the watershed of a legal drain, therefore, a drainage assessment may be assessed by the City of Dallas under the authority of *Chapter 11 of the Georgia State Minimum Standard Plumbing Code*, and so the said Department may exercise all the powers and duties as provide for in said code. This lot contains \_\_\_ ft. of existing legal drain tiles and \_\_\_\_\_ ft. of existing open ditch legal drains.”
  - p) Sheet size
    - i) Minimum 17”x22”
    - ii) Maximum 18”x24”
- 8) Subdivision Plat Requirements – The minor residential subdivision plat application must contain the following information, which may be located on a separate sheet:
- a) Lot boundaries
  - b) Dimensions
  - c) Easements
  - d) Building setback lines
  - e) Waterways
  - f) Floodways
  - g) Floodway fringe
  - h) Street the location to which the property has access
  - i) House layout and location
  - j) Driveway locationShoulder & Roadside Ditch Details
    - i) 7’ shoulder
    - ii) Adequate roadside ditch
- 9) Drainage Improvement
- 10) Sewage disposal systems details (per the Dallas Unified Development Code and/or Paulding County Health Department Requirements)
- 11) Water supply system details
- 12) Erosion and sedimentation control measures
- 13) EXPIRATION OF APPROVAL.
- a) Approval for a minor residential subdivision shall be valid for two years from the date of approval, unless the TAC Committee or the Planning Commission grants an extension. If not granted before the expiration of two (2) years, the approval shall be null and void.

## 14) EXEMPT SUBDIVISION.

- a) Exempt Subdivision procedure applies only to divisions of land for the purpose of splitting off an existing legally conforming residence and accessory structures from a parent tract of land, provided that (1) the new residential parcel meets all current development standards applicable to a residential parcel in the relevant zoning district, and (2) the remaining parent parcel is at least twenty (20) acres in size.
- b) Conditions of Eligibility – Before determining that an application is eligible to be considered as an exempt subdivision, the planning director shall find that all of the following criteria are satisfied:
  - i) Orderly Development – The subdivision will not impede orderly development of land or the provision of public services and improvements.
  - ii) Comprehensive Plan – The subdivision will be consistent with the Comprehensive Plan.
  - iii) Suitability – The lot will provide a suitable residential building site. Land suitability shall be determined by the criteria contained in this ordinance.
  - iv) Endangerment – the exempt subdivision will not be detrimental to, nor endanger, the public health, safety, or general welfare.
  - v) Residential Zoning – The property must be zoned to allow residential development as a permitted use.
  - vi) Right-of-Way – Right-of-way dedication pursuant to the Paulding County Transportation Master Plan.
  - vii) Development Standards – The lot shall meet all current development standards applicable to a residential parcel in the relevant zoning district.
  - viii) Parent Parcel – The remaining parent parcel shall be at least twenty (20) acres in size.
- c) Submittal Requirements
  - i) Application Materials. The application shall include the following:
    - (1) Completed application form
    - (2) Copy of the parent tract deed
    - (3) Subdivision plat drawing
    - (4) Fee
  - ii) Subdivision Plat Drawing – The subdivision plat drawing for an exempt subdivision shall include the following:
    - (1) North arrow
    - (2) Graphical scale
    - (3) Parent tract labeled “Remainder”
    - (4) Proposed lot with the following:
      - (a) Boundary lines and acreage thereof (proposed lot and remainder)
      - (b) Right-of-way
      - (c) Building setback lines
      - (d) Easements
      - (e) Property address
    - (5) Legal description
    - (6) Surveyor’s certification
    - (7) Plat drawings shall be a minimum of 8.5” x 14” in size, and a maximum of 18” x 24” in size.
  - iii) Exempt Subdivision Requirements – The exempts subdivision application must contain the following information, which may be located on a separate sheet:

- (1) Lot boundaries
  - (2) Dimensions
  - (3) Easements
  - (4) Building setback lines
  - (5) Street on which the proposed parcel has access/frontage
  - (6) Location of residence and all accessory structures
  - (7) Location of driveway
- d) Review and Approval
- i) Review of an exempt subdivision application shall be completed within fourteen (14) calendar days of the submission of a complete application.
  - ii) Review shall be carried out by Community Development Department staff.
  - iii) Review shall consist exclusively of determining if the proposed exempt subdivision complies with the relevant development standards of the Zoning Ordinance and Unified Development Code.
  - iv) An application fee shall be paid.
- e) Limit of One Exempt Subdivision Per Parent Tract – Only one (1) exempt subdivision may be created from a parent tract.
- f) Disclaimer - The intent of the exempt subdivision process is to provide a low-cost, administrative means of splitting off an existing, legally established residence from a larger parent tract. The cost of the process is kept low by limiting the subdivision review to conformance with zoning ordinance and subdivision control ordinance development standards only. Conformance with other standards, such as (but not limited to) septic system design, well location regulations, roadside ditch design, and adequate site drainage, are not part of the review. Consequently, approval of an exempt subdivision does not guarantee that the resulting lot is in complete conformance with all Dallas development standards.

**15) EXPIRATION OF APPROVAL**

- a) Approval of an exempt subdivision shall be valid for two (2) years from the date of approval unless the TAC Committee grants an extension. If not granted before the expiration of two (2) years, the approval shall be null and void.

**Sec. 11.08 – ADMINISTRATIVE ADJUSTMENTS**

- 1) **AUTHORITY.** The Community Development Director, or a designee, shall have authority to issue administrative adjustments, but only in accordance with the provisions of this section.
- 2) **PURPOSE.** For purposes of this section, carrying out the strict letter of a provision of this chapter may cause a practical difficulty and an administrative adjustment is permitted to alleviate these practical difficulties.
- 3) **ADMINISTRATIVE ADJUSTMENT STANDARDS.** To approve an application for an administrative adjustment, the Community Development Director shall make an affirmative finding that the following standards are met:
  - a) The benefits to the applicant of the approval of the administrative adjustment outweigh any detriments to the health, safety and welfare of the neighborhood or community by such approval.
  - b) There are no means other than the requested administrative adjustment by which the difficulty can be avoided or remedied to a degree sufficient to permit a reasonable use of the subject lot or parcel.

- c) Strict compliance with the standard would unreasonably prevent the landowner from using the property for a permitted use, or would render conformity necessarily burdensome;
  - d) The particular request, or a lesser relaxation of ordinance standard, would provide substantial justice to the landowner and neighbors;
  - e) The plight is due to unique circumstances of property and is not shared by neighboring properties in the same zone; and
  - f) The problem is not self-created.
- 4) EXTENT OF ADJUSTMENTS
- a) The Community Development Director shall have the authority to approve an administrative adjustment for no more than twenty (20%) percent of the specified mathematical measurement of the Chart of Dimensional Requirements, *Table 7.3: Minimum Parking Space Requirements*, and *Tables 9.01 and 9.02 of the Dallas Sign Ordinance*. Use variances are not permissible under this code section.
- 5) PROCEDURES.
- a) Application. An application for an administrative adjustment shall include a brief description of the requirement to be varied and any other material necessary to ensure the criteria in this section.
    - i) Applications for Administrative Adjustments should be submitted electronically, saved in .pdf format with a maximum 50 MB file size, to the Department of Community Development. No hard copies are required to be submitted. Fees for the administrative adjustment shall be the same as a Variance application.
    - ii) Application Processing. An application shall be considered complete and ready for processing only if it is submitted in the required format, includes all required information and supporting documentation, and is accompanied by the application filing fee. Applications deemed complete by the Community Development Director will be considered to be in the processing cycle and will be reviewed by City Staff. The Director shall make a decision for the application.
  - b) Action by Community Development Director. Within forty-five (45) days, the Community Development Director shall review the application and approve, approve with conditions or deny the application based upon the criteria below. A written decision including affirmative findings on the criteria set forth below shall be mailed to the applicant.
  - c) Approval or Denial.
    - i) The decision of the Development Director regarding an administrative variance shall state the reasons for approval or denial and shall be considered the final decision. In granting an administrative adjustment, the Community Development Director is authorized to impose conditions upon the subject property that are necessary to reduce or minimize any potentially adverse impacts on other property in the surrounding area, and to carry out the stated purpose and intent of this UDO.
  - d) Limitations on administrative adjustments. An administrative adjustment shall become null and void unless a certificate of zoning compliance and/or building permit is obtained and work is commenced within one year from the date of approval.
  - e) Appeals.
    - i) Appeal of a decision by the Community Development Director on an administrative adjustment shall be taken to the City Council within sixty (60) days of the date of the Community Development Director 's decision.
    - ii) An appeal from any final decision of the Community Development Director as to any matter regarding the administrative adjustment may be taken within thirty (30) days of the filing of such decision by any person aggrieved or by any authorized officer, department, bureau, board

or commission of the City.

### Sec. 11.09 – SPECIAL EXCEPTION PROCEDURE

- 1) GENERAL. This section addresses the approval procedure for uses designated as Special Exception Uses (aka. Conditional Uses) in a particular zoning district, according to *Table 4.3: Permitted and Special Exception Land Uses*. Such particular use may be permitted and desirable in certain districts, but not without consideration in each case of the effect of the use upon neighboring land or the effect the neighboring land will have on the use. The determination is made by the Planning Commission.
- 2) CONTENTS OF APPLICATION FOR SPECIAL EXCEPTION PERMIT. An application for a Special Exception permit shall be filed with the Community Development department by at least one (1) owner or agent of the owner of property for which such Special Exception is proposed. At a minimum, the application shall contain the following information:
  - a) Plot or Development Plan. A plot plan, as described in *Subsection 11.12(3)*, or a Development Plan prepared in accordance with the procedures set forth in *Section 11.03 – Development Plan Review and Approval* and including such other information as the Commission may be required to determine if the proposed Special Exception use meets the intent and requirements of this ordinance.
  - b) Letter of Intent. A letter of intent to the Council describing the details of the Special Exception request including but not limited to:
    - i) The ways in which the Special Exception shall comply with the applicable Development Standards of this ordinance;
    - ii) The ways in which the Special Exception shall be consistent with the intent of the applicable section(s) of the Zoning Ordinance; and
    - iii) Any written commitments being made by the petitioner.
  - c) Such other information as may be required by the Planning Commission.
  - d) a fee as established by ordinance.
- 3) PUBLIC NOTICE AND PUBLIC HEARING BY THE PLANNING COMMISSION. Notice of and procedures pertaining to the Public Hearing by the Planning Commission shall be in conformance with the procedures set forth in the Planning Commission Rules of Procedure, as amended.
- 4) DECISION CRITERIA.
  - a) The Planning Commission shall review the particular facts and circumstances of each proposed use in terms of the following standards and shall find adequate evidence showing that the use at the proposed location:
    - i) Is in fact a permitted Special Exception use as listed in each zoning district and appears on *Table 4.3: Permitted and Special Exception Land Uses of Chapter IV: Zoning Districts* for the zoning district involved;
    - ii) Will be harmonious and consistent with the character of the zoning district and in accordance with the general objectives, or with any specific objective of the City's Comprehensive Plan and the Zoning Ordinance;
    - iii) Will be designed, constructed, operated, and maintained so as to be harmonious and

- appropriate in appearance with the existing or intended character of the general vicinity and that such use will not change the essential character of the same area;
- iv) Will be served adequately by essential public facilities and services such as highways, streets, police and fire protection, drainage structures, refuse disposal, water and sewer, and schools; or that the persons or agencies responsible for the establishment of the proposed use shall be able to provide adequately any such services;
  - v) Will not create excessive additional requirements at public cost for public facilities and services and will not be detrimental to the economic welfare of the community;
  - vi) Will not involve uses, activities, processes, materials, equipment and conditions of operation that will be detrimental to any persons, property, or the general welfare by reason of excessive production of traffic, noise, smoke, fumes, glare, or odors;
  - vii) Will have vehicular approaches to the property, which shall be so designed as not to create an interference with traffic on surrounding public thoroughfares; and
  - viii) Will not result in the destruction, loss, or damage of a natural, scenic, or historic feature of major importance.
- b) Other Considerations. When considering a Special Exception use request the Planning Commission may examine the following items as they relate to the proposed use:
- i) Topography and other natural site features;
  - ii) Zoning of the site and surrounding properties;
  - iii) Driveway locations, street access, and vehicular and pedestrian traffic circulation;
  - iv) Parking (including amount, location, and design);
  - v) Landscaping, screening, and buffering of adjacent properties;
  - vi) Open space and other site amenities;
  - vii) Noise, loading areas, odor, and other characteristics of a business or industrial operation;
  - viii) Design and placement of any structures;
  - ix) Placement, design, intensity, height, and shielding of lights;
  - x) Traffic generation; and
  - xi) General site layout as it relates to its surroundings.
- c) All Special Exception uses shall comply with the development standards applicable to the zoning district in which they are located. In addition, the Planning Commission may, as a condition of approval, identify additional development standards on a case-by-case basis. The Commission may use those development standards that apply to districts in which the Special Exception use is a permitted use as a guide for identifying appropriate additional development standards.
- d) Expiration of Special Exception Permit. A Special Exception Permit shall be deemed to authorize only one (1) particular Special Exception Use and the Permit shall automatically expire if, for any reason, the use shall cease for more than one (1) year.

**Sec. 11.10 – PUBLIC NOTICE PROCEDURE**

- 1) GENERAL. For all public hearings, the notice shall be provided to the public consistent with the requirements of this section and the Rules of Procedure, as amended, of the City Council and the

**Sec. 11.11 – ADMINISTRATIVE APPEALS PROCEDURE**

- 1) INTENT. it is the intent of this ordinance that all questions of interpretations and enforcement shall be first presented to the Director.
  - a) The Zoning Board of Appeals may grant an appeal of any decision, interpretation, or determination made by the Director, other City staff members, or any other administrative official or Board charged with the duty of enforcing and interpreting this ordinance.
  - b) The decisions of the Zoning Board of Appeals shall be appealed to the City Council as provided by Georgia law.
  - c) It is further the intent of this ordinance that the duties of the City Council in connection with this ordinance shall not include hearing and deciding questions or interpretation and enforcement that may arise. The procedure for deciding those questions shall be as stated in this section and this ordinance. Under this ordinance, the City Council shall have only the duties of considering and adopting or rejecting proposed amendments or the repeal of this ordinance as provided by law, and of establishing a schedule of fees and charges as stated in *Section 11.15 – Fees*.
- 2) PROCEDURE AND REQUIREMENTS FOR APPEALS AND VARIANCES
  - a) Appeals. Appeals to the Zoning Board of Appeals concerning interpretation or administration of this ordinance may be taken by any person or government entity aggrieved or by any officer or bureau of the legislative authority of the City affected by any decision of the Director. An appeal shall be filed with the Director and with the Zoning Board of Appeals; such notice of appeal specifying the grounds upon which the appeal is being taken. The Director shall transmit to the Zoning Board of Appeals all the papers constituting the record upon which the action appealed was taken.
    - i) The appellant shall submit an administrative appeal application within ten (10) days of the Director’s decision along with the required supporting information. Supporting information shall include, but not be limited to, the following:
      - (1) Original Submittals. Copies of all materials upon which the decision being appealed was based.
      - (2) Written Decisions. Copies of any written decisions that are the subject of the appeal.
      - (3) Appeal Basis. A letter describing the reasons for the appeal noting specific sections of this ordinance and other standards applicable in the City of Dallas upon which the appeal is based.
  - b) Stay of Proceedings. An appeal stays all further proceedings of the action appealed, unless the Director from whom the appeal is taken certifies to the Zoning Board of Appeals after the Notice of Appeal is filed with him/her, that by reason of facts stated in the application, a stay would, in his/her opinion, cause imminent peril to life and property. In this case, proceedings shall not be stayed other than by a restraining order which may be granted by a court of record on application, on notice to the Director from whom the appeal is taken on due cause shown.
  - c) Zoning Board of Appeals Review and Action. The Zoning Board of Appeals will then, at a meeting scheduled consistent with the adopted Calendar of Filing and Meeting Dates, review the

Administrative Appeal application and supporting information.

- i) Representation. The appellant and any representative of the appellant must be present at the meeting to present the appeal.
  - ii) Testimony. The Council shall consider a report from the Director and testimony from the applicant at the meeting and/or witnesses.
  - iii) Procedures. The presentation of reports and testimony and all other aspects of the meeting shall be consistent with the Zoning Board of Appeals Rules of Procedure, as amended.
  - iv) Possible Action. Action by the Zoning Board of Appeals shall be consistent with the Zoning Board of Appeals Rules of Procedure, as amended.
- d) Decision Criteria. The Zoning Board of Appeals shall only grant an appeal of such an administrative decision based on a determination in writing that the decision of the administrative person or Council was inconsistent with the provisions of this ordinance.

### Sec. 11.12 – LAND DISTURBANCE PERMIT

- 1) LAND DISTURBANCE PERMITS REQUIRED. No building or other structure shall be erected, demolished, moved, added to, or altered, changed, placed, or be established or changed in use, on platted or unplatted lands without a permit issued by the Director. The Land Disturbance Permit shall be issued only in conformity with the provisions of this ordinance, the Comprehensive Plan, Subdivision Control Ordinance, Building Code and any other applicable ordinance unless the Director receives a written order from the City Council, Planning Commission or Zoning Board of Appeals deciding an appeal, Special Exception, or variance.
  - a) Agricultural Structures. All agricultural structures shall require a Land Disturbance Permit but shall be exempt from building code inspections and building inspection fees. Review of exempt agricultural structure Land Disturbance Permits shall require the following:
    - i) A signed and recorded affidavit affirming that the applicant is, in fact, building an exempt agricultural structure.
    - ii) A plot plan as described in *Subsection 11.12(3)* to ensure that encroachment into designated floodplains, easements, public rights-of-way, or other non-buildable areas does not occur.
    - iii) Building plans to ensure compliance with Zoning Ordinance development standards.
    - iv) An on-site inspection for compliance with all applicable ordinances.
    - v) Issuance of a Certificate of Completion before occupancy of the structure.
- 2) APPLICATION FOR LAND DISTURBANCE PERMIT
  - a) The Director shall issue a Land Disturbance Permit upon written application when the proposed structure, improvement, or use and its location conform in all respects to the *Comprehensive Plan, Zoning Ordinance, Subdivision Control Ordinance, Storm Drainage, Erosion and Sediment Control Ordinance, Building Code*, and any other applicable ordinances of the City of Dallas.
  - b) An application for a Land Disturbance Permit can be obtained from the Dallas Community Development department. The application shall be signed by the owner or agent attesting to the truth and exactness of all information supplied on the application. Each application shall clearly state that the permit shall expire and may be revoked if work has not begun within one (1) year or completed within two (2) years.

- c) Every application for a Land Disturbance Permit shall be accompanied by one (1) copy of a plot plan, drawn to scale
- 3) PLOT PLANS. Where applicable, a plot plan shall be signed and sealed by a professional engineer or licensed land surveyor. A plot plan shall show, at a minimum:
- a) Name, address, and phone number of applicant;
  - b) The location of the structure, improvement, or use to be altered, demolished, changed, placed, erected, or located;
  - c) Legal description of property;
  - d) Existing and proposed streets and alleys adjoining or within the lot and the manner in which the location is to be improved; and
  - e) Use of proposed structure;
  - f) Existing zoning district;
  - g) Plans drawn to scale, showing the actual dimensions and the shape of the lot to be built upon, the exact size and location of existing buildings on the lot, and the location and dimensions of the proposed building or alteration and other requirements as established by resolution by the Planning & Zoning Commission;
  - h) The size of the yards and open spaces;
  - i) Type of structure, type of structural work, and structural plans in accordance with the requirements of the Dallas Building Code ordinance;
  - j) Building height;
  - k) Number of off-street parking spaces and loading spaces;
  - l) Type and source of sewage disposal, and type and source of water supply;
  - m) Number of dwelling units; and
  - n) Such other matters as may be necessary to determine conformance with, and provide for the enforcement of this ordinance.
  - o) Submittal of a development plan will be required for certain structures, including the requirements as established by resolution by the Planning & Zoning Commission, certified by a land surveyor or engineer registered in the State of Georgia. A record shall be kept of all applications in the office of Community Development.
- 4) APPROVAL OF LAND DISTURBANCE PERMIT. Within thirty (30) days after the receipt of an application, the Director shall either approve, approve with modifications, or disapprove the application in conformance with the provisions of this ordinance. An applicant that has submitted a permit application containing any defect shall be notified of the defect. Any application that is not approved within thirty (30) days of the notice shall be disapproved. After, the Director shall have marked the copy either as approved, approved with modifications, or disapproved and attested to same by his signature on the copy. One (1) copy of plans, similarly marked, shall be retained by the Director. The Director shall issue a placard, to be posted in a conspicuous place on the property in question, attesting to the fact that the use or alteration is in conformance with the provisions of this ordinance. Any decision of the Director concerning the issuance of a Land Disturbance Permit may be appealed

to the Zoning Board of Appeals by any person claiming to be adversely affected by the decision.

- 5) EXPIRATION OF LAND DISTURBANCE PERMIT. If the work described in any Land Disturbance Permit has not been completed within two (2) years from the date of issuance, the permit shall expire. If the first required inspection has not been approved for the work described in any Land Disturbance Permit within one (1) year from the date of issuance, the permit shall expire. One (1) extension, for either the start or completion time frame, may be granted by the Director for good cause shown by the applicant. The extension shall not exceed six (6) months in time.
- 6) RECORD OF LAND DISTURBANCE PERMIT. The Director shall maintain a record of all Land Disturbance Permits.
- 7) FAILURE TO OBTAIN A LAND DISTURBANCE PERMIT. Failure to obtain a Land Disturbance Permit shall be a violation of this Ordinance and punishable under *Chapter XII: Violations and Enforcement*.
- 8) CONSTRUCTION AND USE TO BE AS PROVIDED IN APPLICATION, PLAN, PERMIT, AND CERTIFICATE. Land Disturbance Permits and Certificates of Occupancy issued on the basis of plans and applications approved by the Director authorized only the use and arrangement, set forth in the approved plans and applications or amendments, and no other use, arrangement, or construction. Use, arrangement, or construction contrary to that authorized shall be deemed a violation of this ordinance, and punishable as provided in *Chapter XII: Violations and Enforcement*.

**Sec. 11.13 – CERTIFICATE OF OCCUPANCY, CERTIFICATE OF TEMPORARY OCCUPANCY, CERTIFICATE OF CONTINUED OCCUPANCY AND CERTIFICATE OF COMPLETION**

- 1) CERTIFICATE REQUIREMENTS. No land shall be occupied or used and no structure or building erected, reconstructed or structurally altered shall be occupied or used, in whole or in part, for any (non-exempt) purpose whatsoever, until a Certificate of Occupancy shall have been issued by the Director stating that the building and use comply with all of the provisions of this ordinance applicable to the building or premises or the use in the district in which it is to be located.
  - a) No change shall be made in any building, structure, or part erected, reconstructed, or structurally altered without a Land Disturbance Permit having been issued by the Director.
  - b) No permit shall be issued to make a change unless it is in conformance with the provisions of this ordinance.
  - c) A Certificate of Occupancy shall be applied for coincidentally with the application for a Land Disturbance Permit and shall be issued within ten (10) days after the lawful erection, reconstruction, or structural alteration of a building or structure shall have been completed.
- 2) TEMPORARY CERTIFICATE OF OCCUPANCY. A temporary Certificate of Occupancy may be issued by the Director for a period of six (6) months during alterations or partial occupancy of a building or structure pending its completion. The temporary Certificate of Occupancy may be renewed by the Director for a period not to exceed six (6) months for good cause shown by the applicant.
- 3) RECORD OF CERTIFICATE OF OCCUPANCY. The Director shall maintain a record of all Certificates of Occupancy.
- 4) FAILURE TO OBTAIN A CERTIFICATE OF OCCUPANCY. Failure to obtain a Certificate of Occupancy shall

be a violation of this Ordinance and punishable under *Chapter XII: Violations and Enforcement*.

- 5) CONSTRUCTION AND USE TO BE AS PROVIDED IN APPLICATION, PLAN, AND CERTIFICATE. Certificates of Occupancy issued on the basis of plans and applications approved by the Director authorized only the use and arrangement set forth in the approved plans and applications or amendments and no other use, arrangement, or construction. use, arrangement, or construction contrary to that authorized shall be deemed a violation of this ordinance and punishable as provided in *Chapter XII: Violations and Enforcement*.
- 6) CERTIFICATE OF COMPLETION. For structures that are not intended to be inhabited, such as pools and similar structures, a Certificate of Completion is required. The procedures and standards for a Certificate of Completion shall be the same as those for a Certificate of Occupancy, set forth in *Subsections 11.13(1) through (5)*.

#### **Sec. 11.14 – SIGN PERMIT**

---

- 1) GENERAL PERMIT PROCEDURES. The following procedures shall govern the application for, and issuance of, all sign permits under this ordinance, and the submission and review of Signage Plans under the Development Plan review as established in *Section 11.03 – Development Plan Review and Approval*.
  - a) Applications. All applications for sign permits of any kind and for approval of Signage Plans shall be submitted to the Director on an application form, as part of the Development Plan review process, or in accordance with the application specifications published by the Director.
  - b) Fees. Applicable fees for a sign permit, as established by the fee schedule, shall be paid upon issuance of the permit.
  - c) Completeness. Within fourteen (14) working days (excluding Saturday, Sunday, and holidays) of receiving an application for a sign permit or for a Signage Plan the Director shall review it for completeness. if the Director finds that it is complete, the application shall then be processed. if the Director finds that it is incomplete, the Director shall, within such five (5) day period, notify the applicant of the specific ways in which the application is deficient, with appropriate references to the applicable sections of the ordinance.
  - d) Action. Within fourteen (14) working days (excluding Saturday, Sunday, and holidays) of the submission of a complete application for a sign permit, the Director shall either:
    - i) Issue the sign permit if the sign that is the subject of the application conforms in every respect with the requirements of this ordinance; or
    - ii) Reject the sign permit if the sign that is the subject of the application fails in any way to conform with the requirements of this ordinance.
- 2) PERMITS TO CONSTRUCT OR MODIFY SIGNS. Permanent signs shall be erected, installed, modified or created only in accordance with a duly issued and valid sign construction permit from the Director. Such permits shall be issued only in accordance with the following requirements and procedures:
  - a) Permit for new Sign or for Sign Modification. An application for construction, creation, or installation of a new sign or for modification of an existing sign shall be accompanied by detailed drawings to show the dimensions, design, structure, and location of each particular sign, including

the location of right-of-way. One (1) application and permit may include multiple signs on the same property.

- b) Inspection. The Director shall cause an inspection of the property for which each permit for a new sign or for modification of an existing sign is issued. If the construction is complete and in full compliance with this ordinance and with the building and electrical codes, the Director shall issue a Certificate of Completion. If the construction is substantially complete but not in full compliance with this ordinance and applicable codes, the Director shall give the owner or applicant notice of the deficiencies and shall allow an additional thirty (30) days from the date of inspection for the deficiencies to be corrected. If the deficiencies are not corrected by that date, the Director shall take appropriate action. If the construction is then complete, the Director shall issue a Certificate of Completion.
- 3) **MASTER PLAN.** No permit shall be issued for an individual sign requiring a permit unless and until a Master Signage Plan for the lot or parcel on which the sign will be erected has been submitted to the Director and approved by the Director as conforming with this section.
- a) Individual Sign Permit and Master Signage Plan. For any lot or parcel on which the owner proposes to erect one or more signs requiring a permit, the owner shall submit to the Community Development department a Master Signage Plan containing the following:
    - i) An accurate plot plan of the lot or parcel, at such scale as the Director may reasonably require;
    - ii) Location of buildings, parking lots, driveways, and landscaped areas on such lot or parcel;
    - iii) Computation of the maximum total sign area, the maximum area for individual signs, the height of signs and the number of freestanding signs allowed on the lots or parcels included in the plan under this chapter; and
    - iv) An accurate indication on the plot plan of the proposed location of each present and future sign of any type, whether requiring a permit or not, except that incidental signs need not be shown.
    - v) Dimensions of lot including setbacks from right-of-way.
  - b) Showing Window Signs on Master Signage Plan. A Master Signage Plan including window signs may simply indicate the areas of the windows to be covered by window signs and the general type of the window signs (e.g., paper-affixed, painted, etched on glass, or some other material hung inside window) and need not specify the exact dimension or nature of every window sign.
  - c) Limit on Number of Freestanding Signs under Master Signage Plan. The Master Signage Plan, for all lots or parcels with multiple uses or multiple users, shall limit the number of freestanding signs to a total of one (1) for each street on which the lots or parcels included in the plan have frontage and shall provide for shared or common usage of such signs.
  - d) Other Provisions of Master Signage Plans. The Master Signage Plan may contain such other restrictions as the owners of the lots or parcels may reasonably determine.
  - e) Consent. The Master Signage Plan shall be signed by all owners or their authorized agents on such form as the Director shall require.
  - f) Procedures. A Master Signage Plan shall be included in any Development Plan, planned unit Development Plan, or other official plan required by the City for the proposed development and

shall be processed simultaneously with such other plan.

- g) Amendments. A Master Signage Plan may be amended by filing a new Master Signage Plan that conforms with all requirements of this section then in effect.
  - h) Existing Signs Not Conforming to Master Signage Plan. Existing nonconforming signs shall be made conforming to current standards if new signage is proposed.
  - i) Binding Effects. After approval of a Master Signage Plan, no sign shall be erected, placed, painted, or maintained, except in conformance with such plan, and such plan may be enforced in the same way as any provision of this section. In case of any conflict between the provisions of such a plan and any other provision of this ordinance, this ordinance shall control.
- 4) TIME LIMIT OF PERMIT. A sign permit shall expire one (1) year after issuance unless construction has begun.
- 5) ASSIGNMENT OF SIGN PERMITS. A current and valid sign permit shall be freely transferable to a successor as owner of the property or holder of a business license for the same premises if there are no changes of any kind to the sign.

#### Sec. 11.15 – SEXUALLY ORIENTED BUSINESS PERMIT

##### 1) GENERAL PROVISIONS

- a) A valid sexually oriented business permit issued by the City for the particular type of business shall be obtained prior to the establishment of or operation of a sexually oriented business.
- b) An application for a permit must be made on a form provided by the Dallas Community Development department. The application must be accompanied by a sketch or diagram showing the configuration of the premises, including a statement of total floor space occupied by the business. The sketch or diagram need not be professionally prepared, but must be drawn to a designated scale or drawn with marked dimensions of the interior of the premises to an accuracy of plus or minus six (6) inches.
- c) The applicant must be qualified according to the provisions of this section and the premises must be inspected and found to be in compliance with the law by the health department, fire department, and the Community Development department.
- d) The permittee shall, within thirty (30) days after the issuance of the permit referred to herein, deliver to the Community Development department a list containing the names and addresses of all employees. The permittee shall update the list within thirty (30) days of any change or addition of employees. This list, or update, shall be signed, under oath, by the permittee.
- e) If a person who wishes to operate a sexually oriented business is an individual, he/she must sign the application for a permit as applicant. If a person who wishes to operate a sexually oriented business is other than an individual, each individual who has a ten (10) percent or greater interest in the business must sign the application for a permit as applicant.
- f) The fact that a person possesses other types of state, county, or city permits does not exempt him/her from the requirement of obtaining a sexually oriented business permit.

##### 2) ISSUANCE OF PERMIT

- a) The Director shall approve the issuance of a permit to an applicant within thirty (30) days after receipt of an application unless he finds one or more of the following to be true:

- i) An applicant is under eighteen (18) years of age.
  - ii) An applicant or an applicant's spouse is overdue in his payment to the City of taxes, fees, fines, or penalties assessed against or imposed upon him in relation to a sexually oriented business.
  - iii) An applicant has failed to provide information reasonably necessary for issuance of the permit or has falsely answered a question or request for information on the application form.
  - iv) An applicant is residing with a person who has been denied a permit by the City to operate a sexually oriented business within the preceding twelve (12) months, or is residing with a person whose permit to operate a sexually oriented business has been revoked within the preceding twelve (12) months.
  - v) The premises to be used for the sexually oriented business have not been approved by the health department, fire department, and the Community Development department as being in compliance with applicable laws and ordinance.
  - vi) The permit fee required by this ordinance has not been paid.
  - vii) An applicant of the proposed establishment is in violation of, or is not in compliance with any of the provisions of this ordinance.
- b) The permit, if granted, shall state on its face the name of the person or persons to whom it is granted, the expiration date, and the address of the sexually oriented business. The permit shall be posted in a conspicuous place at or near the entrance to the sexually oriented business so that it may be easily read at any time.
- c) Regulations Pertaining to Exhibition of Sexually Explicit Films or Videos
- i) A person who operates or causes to be operated a sexually oriented business, other than an adult motel, which exhibits on the premises in a viewing room, a film, video cassette, or other video reproduction which depicts specified sexual activities or specified anatomical areas, shall comply with the following requirements:
    - (1) Upon application for a sexually oriented permit, the application shall be accompanied by a diagram of the premises showing a plan thereof specifying the location of one or more manager's stations and the location of all overhead lighting fixtures and designating any portion of the premises in which patrons will not be permitted. A manager's station may not exceed thirty-two (32) square feet of floor area. The diagram shall also designate the place at which the permit will be conspicuously posted, if granted. A professionally prepared diagram in the nature of an engineer's or architect's blueprint shall not be required; however, each diagram should be oriented to the north or to some designated street or object and should be drawn to a designated scale or with marked dimensions sufficient to show the various internal dimensions of all areas of the interior of the premises to an accuracy of plus or minus six (6) inches. The Director may waive the foregoing diagram for renewal applications if the applicant adopts a diagram that was previously submitted and certifies that the configuration of the premises has not been altered since it was prepared;
    - (2) The application shall be sworn to be true and correct by the applicant;
    - (3) No alteration in the configuration or location of a manager's station may be made without the prior approval of the Director or his/her designee;
    - (4) It is the duty of the owners and operators of the premises to ensure that at least one (1) employee is on duty and situated in each manager's station at all times that any patron is

- present inside the premises;
- (5) The interior of the premises shall be configured in such a manner that there is an unobstructed view from a manager's station of every area of the premises to which any patron is permitted access for any purpose excluding restrooms. Restrooms may not contain video reproduction equipment. If the premises has two (2) or more manager's stations designated, then the interior of the premises shall be configured in such a manner that there is an unobstructed view of each area of the premises to which any patron is permitted access for any purpose from at least one (1) of the manager's stations. The view required in this subsection must be by direct line of sight from the manager's station;
  - (6) It shall be the duty of the owners and operator, and it shall also be the duty of any agents and employees present in the premises to ensure that the view area specified in Subsection (5) remains unobstructed by any doors, walls, merchandise, display racks or other materials at all times and to ensure that no patron is permitted access to any area of the premises which has been designated as an area in which patrons will not be permitted in the application filled pursuant to *Subsection (1)* of this section;
  - (7) No viewing room may be occupied by more than one (1) person at any time;
  - (8) The premises shall be equipped with overhead lighting fixtures of sufficient intensity to illuminate every place to which patrons are permitted access at an illumination of not less than one (1) foot-candle as measured at the floor level; and
  - (9) It shall be the duty of the owners and operator and it shall also be the duty of any agents and employees present in the premises to ensure that the illumination described above is maintained at all times that any patron is present in the premises.
- d) A person having a duty under *Subsection 11.15(2)(c)(i)(1-9)* above commits a violation if he/she knowingly fails to fulfill that duty.
- 3) EXEMPTIONS. A modeling class operated in accordance with the requirements below shall be exempt from the issuance of a sexually oriented business permit of *Section 11.15 – Sexually Oriented Business Permit* and shall not constitute a "sexually-oriented business" or an "adult use". The modeling class shall be operated:
- a) By a school, licensed by the State of Georgia; a college, junior college, or university supported entirely or partly by taxation;
  - b) By a private college or university which maintains and operates educational programs in which credits are transferable to a college, junior college, or university supported entirely or partly by taxation; or
  - c) In a structure:
    - i) Which has no sign visible from the exterior of the structure and no other advertising that indicates a nude person is available for viewing;
    - ii) Where in order to participate in a class a student must enroll at least three (3) days in advance of the class; and
    - iii) Where no more than one (1) nude model is on the premises at any one time.
- 4) INSPECTION.
- a) An applicant or permittee shall permit representatives of the City police department, and any local fire department, Dallas Community Development department, or other City departments or agencies to inspect the premises of a sexually oriented business for the purpose of insuring

- compliance with the law at any time it is occupied or open for business.
- b) A person who operates a sexually oriented business or his agent or employee commits a violation of this ordinance if he refuses to permit such lawful inspection of the premises at any time it is occupied or open for business.
- 5) EXPIRATION OF PERMIT
- a) Each permit shall expire one (1) year from the date of issuance and may be renewed only by making application as provided in *Subsection 11.15(2)*. Application for renewal should be made at least thirty (30) days before the expiration date, and when made less than thirty (30) days before the expiration date, the expiration of the permit will not be affected.
  - b) When the Director denies renewal of a permit, the applicant shall not be issued a permit for one (1) year from the date of denial. If, subsequent to denial, the Director finds that the basis for denial of a renewal permit has been corrected or abated, the applicant may be granted a permit if at least ninety (90) days have elapsed since the date the denial became final.
- 6) SUSPENSION. the Director shall suspend a permit for a period not to exceed thirty (30) days if he determines that a permittee or an employee of a permittee has:
- a) Violated or is not in compliance with any section of this ordinance;
  - b) Engaged in excessive use of alcoholic beverages while on the sexually oriented business premises;
  - c) Refused to allow an inspection of the sexually oriented business premises as authorized by this chapter; and
  - d) Knowingly permitted gambling by any person on the sexually oriented business premises.
- 7) REVOCATION
- a) The Director shall revoke a permit if a cause of suspension in *Subsection 11.54(6)* occurs and the permit has been suspended with the preceding twelve (12) months.
  - b) The Director shall revoke a permit if he/she determines that:
    - i) A permittee gave false or misleading information in the material submitted to the Community Development department during the application process;
    - ii) A permittee or an employee has knowingly allowed possession, use or sale of controlled substances on the premises;
    - iii) A permittee or an employee has knowingly allowed prostitution on the premises;
    - iv) A permittee or an employee has knowingly operated the sexually oriented business during a period of time when the permittee's permit was suspended;
    - v) A permittee or an employee has knowingly allowed any act of sexual intercourse, sodomy, oral copulation, masturbation, or other sexual conduct to occur in or on the permitted premises; or
    - vi) A permittee is delinquent in payment to the City, County, or State for any taxes or fees past due.
  - c) When the Director revokes a permit, the revocation shall continue for one (1) year, and the permittee shall not be issued a sexually oriented business permit for one (1) year from the date revocation became effective. If, subsequent to revocation, the Director finds that the basis for the revocation has been corrected or abated, the applicant may be granted a permit if at least ninety (90) days have elapsed since the date the revocation became effective.
- 8) TRANSFER PERMIT. A permittee shall not transfer his permit to another, nor shall a permittee operate a sexually oriented business under the authority of a permit any place other than the address

designated in the application.

- 9) VIOLATIONS; SEXUALLY ORIENTED BUSINESS INJUNCTION. A person who owns real estate upon which a sexually oriented business is located, operates, or causes to be operated a sexually oriented business without a valid permit or in violation of *Section 11.15 – Sexually Oriented Business Permit* is subject to a suit for injunction as well as prosecution for violations. Such violations shall be punishable by a fine of two-thousand five-hundred dollars (\$2,500.00) per violation. Each day that a violation exists shall constitute a separate offense. Suit may be commenced by the Dallas City Attorney or the Prosecuting Attorney of the 5th Circuit Superior Court District of Georgia.

**Sec. 11.16 – FEES**

---

1) ESTABLISHMENT OF FEES

- a) The fees for all applicant costs incurred in this ordinance shall be established by the Dallas City Council. Furthermore, no plan shall be accepted for filing and processing, as provided in this ordinance, unless and until a filing fee is paid to the City and the application is deemed complete by the City.
- b) The applicant shall be responsible for unforeseen expenses incurred by the City in reviewing the plan or any modifications to the plan. Such expenses may include items such as the cost of professional services including expenses and legal fees in connection with reviewing the plan, prepared reports, inspections, the publication and mailing of public notice in connection therewith, and any other reasonable expenses directly attributable thereon.
- c) Failure to pay the above costs within thirty (30) days of invoice shall stop all processing and review of the site development Plans or shall cause suspension of all development activities on the site.

2) SCHEDULE OF FEES

- a) The City of Dallas shall establish a schedule of fees for Land Disturbance Permits, amendments, appeals, variances, Special Exception use permits, plan approvals, and other matters pertaining to the administration and enforcement of this ordinance requiring investigations, inspections, legal advertising, postage, and other expenses. Such expenses may include items such as the cost of using professional services to review plans or applications.
- b) The schedule of fees shall be posted in the office of the City Clerk.
- c) Until all applicable fees have been paid in full, no action shall be taken on any application or appeal. Upon the finding of a zoning ordinance violation by a court of competent jurisdiction, the Court may award the City a reasonable attorney fee for the prosecution of said action.
- d) All application and filing fees are nonrefundable regardless of the outcome of the application. This can be waived by the Director.

**Sec. 11.17 – FOOD TRUCKS AND MOBILE FOOD VENDORS**

---

1) GUIDELINES

- a) Mobile food vendors (a mobile food dispensing vehicle that sells prepared food products) and mobile units that sell agricultural produce may be permitted, subject to the approval of a mobile food vendor permit by the Mayor and City Council and the presentation of written permission from the property owner on whose property the mobile food vendor is to be located. All mobile food

vending businesses shall be subject to the following criteria:

- i) A mobile food vending business shall be treated and permitted as a Peddler and subject to the regulations thereof.
- ii) All mobile food units shall be self-contained.
- iii) All required Georgia Department of Public Health permits must be obtained and copies provided.
- iv) No mobile food vendor shall be allowed to operate in excess of four (4) consecutive days in any one location, unless they have the Mayor or City Council's written approval to operate at one location for an extended period of time related to a special event lasting more than four days. During days of non-operation, the mobile food vendor and all associated vehicles, etc. must be removed from the premises.
- v) Only one mobile food unit shall be permitted on a site smaller than a quarter ( $\frac{1}{4}$ ) acre. A maximum of five mobile food units shall be permitted within a "mobile food unit park" – a.k.a. "food truck court" site larger than quarter ( $\frac{1}{4}$ ) acre but smaller than a  $\frac{1}{2}$  acre, unless approved otherwise in writing by the Mayor and City Council for a special event, community event or festival.
- vi) Mobile food vendors shall only be located and operated in areas or districts zoned non-residential unless they are temporarily operated for specific events held at an institution (i.e. church, school, etc.) that is located on a parcel zoned for residential.
- vii) No more than one mobile food vendor shall operate on the same site per day unless they have the Mayor and City Council's written approval related to a special event or the site is permitted as a "mobile food unit park" – a.k.a. "food truck court."
- viii) Signage will be limited to signage located on the mobile food unit. No portable signage is allowed, with the exception of a sandwich board style sign.
- ix) Property owners renting space to one or more mobile food units (constituting a "mobile food unit park" – a.k.a. "food truck court") shall be considered lessors and shall be required to pay the same annual business license rate per rental space as required of other landlords.
- x) Vending structures shall not be left unattended or stored at any time on the open vending site when vending is not taking place or during restricted hours of operation.



- b) A minimum of four parking spaces per site shall be required for the use of the mobile vendor patrons. Mobile food vendors may not occupy parking spaces required to fulfill the minimum requirements of the principal use, unless they have written approval of the Mayor or City Council.
- c) No mobile vendor shall operate in the following areas:
  - i) Within ten feet from the right-of-way of any public street or roadway.
  - ii) Within a required landscape buffer or improvement setback.
  - iii) Within ten feet of any street intersection or cross walk.
  - iv) Within ten feet of any driveway or other curb cut access, loading zone, or designated transit stop.
  - v) In any area within fifteen (15) feet of a building entrance.
  - vi) On the median strip of a divided roadway.
  - vii) In front of display windows of a fixed location business.
  - viii) Within ten feet of a fire hydrant or fire escape.
  - ix) Within ten feet of any parking space or access ramp designated for persons with disabilities.
  - x) On unpaved surfaces, or City property unless otherwise permitted by the Dallas City Council.
- d) No vending cart or stand, or any other item related to the operation of a mobile vendor use, shall be located on any city sidewalk or other public way during non-vending hours. Nor shall any vehicle be parked, stored or left overnight on any city sidewalk or other public way.
- e) Vendors shall keep the sidewalks, roadways and other spaces adjacent to their vending sites or locations clean and free of paper, peelings, and refuse of any kind generated from their business. All trash or debris accumulating within twenty-five (25) feet of any vending stand shall be collected by the vendor and deposited in a trash container provided by the vendor. The trash container shall

be emptied regularly and marked as being for litter.

- f) Mobile vendors may not do any of the following:
  - i) Obstruct pedestrian or motor vehicle traffic flow.
  - ii) Obstruct traffic signals or regulatory signs.
  - iii) Obstruct adequate access to emergency and sanitation vehicles.
  - iv) Interfere with access to abutting properties.
  - v) Sound any device that produces a loud noise or operate any loudspeaker, public address system, radio, sound amplifier, or similar device to attract public attention.
- g) All mobile food vendors are required to have a grease trap that meets the specifications of the City's Public Works Department in addition to any linked physical address. Proof of this installation shall accompany the application for a license.

## 2) LICENSE REQUIRED.

- a) It shall be unlawful for any person to sell, or offer for sale, food of any type from a commissary, mobile retail food establishment, pushcart or temporary food establishment without a license first having been granted under this section, except for city-sponsored events.
- b) An application for a license or a permit hereunder shall be submitted to the community development director or his or her designee setting forth all information required hereunder and in compliance with this article. The community development director or his or her designee shall develop a form of application for the purpose of compliance with this article.
- c) The following information shall be provided with each application for a food truck vendor permit:
  - i) Name of the food truck vendor;
  - ii) Make, model, and license plate number of vending unit;
  - iii) Owner's contact information;
  - iv) Operator's contact information;
  - v) Type of vendor (street vending unit or sidewalk vending unit);
  - vi) Copy of approved permit from the Paulding County Health Department;
  - vii) List of operating locations and times;
  - viii) Signatures from property owners indicating consent for the use of their property;
  - ix) Signature of applicant indicating agreement to the listed requirements.
- d) No sale or offer for sale shall be made from a food truck vendor unless the vehicle is marked, in letter and numbers at least three inches in height, with the name and address of the food truck vendor licensee.
- e) The food truck vendor shall comply with all state, federal and local health and safety regulations and requirements and shall obtain and maintain any and all licenses required by any other health organization or governmental organization having jurisdiction over this subject matter. An inspection by the Paulding County Fire Marshall's office and Building Official shall be required for all mobile food vendors.

## 3) PENALTIES

- a) Any person violating any provision of this article may be issued a citation by the Dallas Police Department or summons and shall be required to appear in the Dallas Municipal Court. Upon conviction, any person shall be subject to any fines and other applicable court costs which may be assessed by the Dallas Municipal Court.

4) EXCEPTIONS

- a) The Mayor and City Council may provide written approval, related to a special event, of the following exceptions: duration, location, and hours of operation.

5) INDEMNITY

- a) As part of the permitting process set forth herein, any person or entity receiving a permit set forth herein shall execute an indemnity agreement indemnifying and releasing the City of Dallas, its agents, employees and elected officials from any and all liability against any and all claims, actions and suits of any type whatsoever.

6) REVOCATION AND SUSPENSION

- a) The city shall have the right to revoke or suspend any license granted hereunder.

7) FEE

- a) The fee for every application for license under this section shall be set by the city council.

Figure 11.2: Food Truck General Requirements

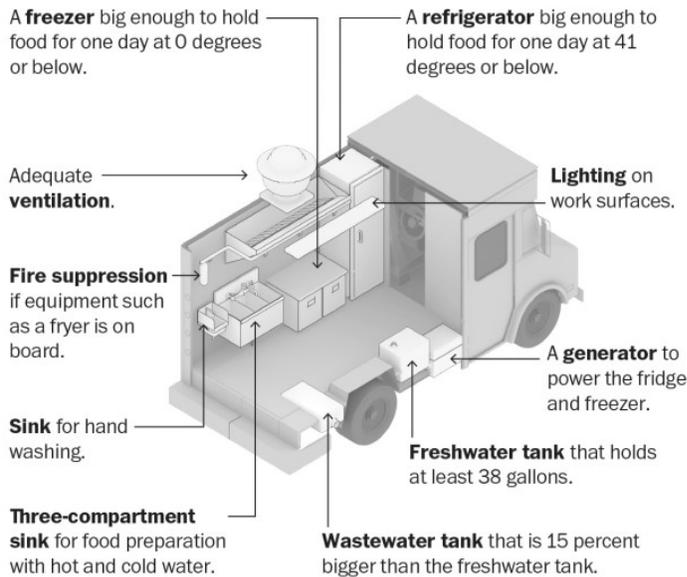

**CHAPTER XII: VIOLATIONS AND ENFORCEMENT****Sec. 12.01 – ENFORCEMENT**

---

- 1) It shall be the duty of the Community Development Director, or his/her designee, to enforce the provisions of this Ordinance in the manner and form and with the powers provided in the laws of the State of Georgia and in the Zoning Ordinance of City of Dallas.

**Sec. 12.02 – ZONING VIOLATIONS**

---

- 1) DESCRIPTION OF A VIOLATION
  - a) Whoever violates any of the provisions below shall be guilty of an ordinance violation. Each day during which a set of facts exists that constitutes a violation or offense, it shall constitute a separate offense.
    - i) Failure to comply with any rightful order issued pursuant to the regulations of this Ordinance.
    - ii) Failure to obtain the necessary Land Disturbance Permit, or failure to obtain the necessary Certificate of Occupancy or any other necessary permit as established in this Ordinance.
    - iii) Failure to comply with the provisions or regulations of this Ordinance in the construction, reconstruction, erection, location, alteration, occupancy, or use of a building, structure or any part thereof, or the use of any land.
    - iv) Permitting another person to use a building, structure, or land owned by him, who fails to comply with any of the foregoing.
    - v) Failure to comply with a representation made in the application for a zoning certificate or an occupancy certificate or any other permit.
    - vi) Failure to comply with zoning requirements.
    - vii) Failure to meet any obligation or requirement of this Ordinance.
  - b) Whoever knowingly makes a false statement, or knowingly swears or affirms the truth of a false statement previously made when any of the conditions set forth in the provisions below apply, shall be guilty of an ordinance violation for each separate offense. Where contradictory statements relating to the same fact are made by the offender within the applicable period of the statute of limitations, it is not necessary to show which statement was false, but only that any of them were false, to constitute a violation of this Ordinance.
    - i) The statement is made for the purpose of misleading any member of the Planning & Zoning Commission, City Council, Council of Commissioners or any City Official into performing any duty or making any determination required under this Ordinance.
    - ii) The statement is made with purpose to secure the issuance of any permit or certificate.
    - iii) The statement has been sworn or affirmed before a notary public or other person empowered to administer oaths.
    - iv) The statement is in writing or in connection with a report, application, or study that is required or authorized.
  - c) No person shall fail or refuse to comply with an order issued by the Community Development Director, or his/her designee. Furthermore, no person shall construct, modify, alter, use or occupy any structure or property in violation of the City of Dallas Zoning Ordinance.

- 2) COMPLAINT REGARDING VIOLATION. Whenever a violation of this Ordinance occurs, or is alleged to have occurred, any person may register a complaint. The complaint stating fully the causes and basis of the complaint shall be filed with the Community Development Director. The Director, or his/her designee, shall properly record the complaint, investigate, and take action on the complaint as provided by this Ordinance.
- 3) NOTICE OF VIOLATION. The notice of any violation of this Zoning Ordinance shall be as follows:
  - a) Whenever the Director, or his/her designee, determines that there is a violation of any provision of this Zoning Ordinance, a notice of such violation shall be issued. Such notice shall:
    - i) Be in writing;
    - ii) Identify the violation;
    - iii) Include a statement of the reason or reasons why it is being issued and refer to the section of this Zoning Ordinance being violated; and
    - iv) State the time by which the violation shall be corrected.
  - b) Service of notice of the violation shall be as follows:
    - i) By personal delivery to the person or persons responsible, or by leaving the notice at the usual place of residence of the owner with a person of sixteen (16) years or older; or
    - ii) By certified mail, and first class mail simultaneously, addressed to the person or persons responsible at a last known address. Service shall be deemed complete when the fact of the mailing is entered of record, provided that the first class mail envelope is not returned by the Postal Authorities with an endorsement showing failure of delivery; or
    - iii) By posting a copy of the notice form in a conspicuous place on the premises found in violation.
- 4) ACTION AGAINST A VIOLATION. For any building or structure that is, or is proposed to be, located, erected, constructed, reconstructed, enlarged, changed, maintained or used, or any land that is proposed to be used in violation of this Ordinance or any amendment or supplement thereto, the City Council, the City of Dallas Planning & Zoning Commission, Zoning Board of Appeals, the Community Development Director, or any adjacent or neighboring property owner who would be specifically damaged by such violation may, in addition to other remedies provided by law, institute appropriate action or proceedings to prevent such unlawful location, erection, construction, reconstruction, alteration, conversion, maintenance or use which may include the holding of building permits, Certificates of Occupancy, or other permits; to restrain, correct or abate such violation to prevent the occupancy of the said building, structure or land or to prevent any illegal act, conduct, business or use in or about, such premises.
- 5) VIOLATION OF WRITTEN COMMITMENTS. Written commitments may be enforced jointly or severally by:
  - a) The City of Dallas Planning & Zoning Commission, Zoning Board of Appeals, or City Council;
  - b) Owners of all parcels of ground adjoining the real estate to a depth of two (2) ownerships, but not exceeding six-hundred sixty (660) feet from the perimeter of the real estate, and all owners of real estate within the area included in the petition who were not petitioners for approval; and,
  - c) Any party the owner designates on the Development Commitment Recording Form at the time of recording.

**Sec. 12.03 – CONSTRUCTION PROCESS VIOLATIONS**

---

- 1) STOP WORK ORDERS. The Community Development Director or Chief Building Official may place a Stop-Work Order on any land/property improvement process.
  - a) Procedure. Stop-Work Orders shall be issued by written letter that shall state the nature of the violation and that the work and/or any other illegal activity must stop immediately until the matter is resolved. If the property is occupied by someone other than the property owner, a copy of said Stop-Work Order shall be provided to said occupant(s). This letter shall be posted in a conspicuous place and be delivered/ mailed to the property owner.
  - b) Reasons. Reasons for a Stop-Work Order include, but are not limited to:
    - i) Not complying with any element of the development standards and/or any regulation of this Ordinance.
    - ii) Not obtaining a Land Disturbance Permit or any other required permit or approval prior to the construction or installation of any improvement for which an approval or permit is required by this Ordinance.
    - iii) Not completing structures or other improvements consistent with any approved Land Disturbance Permit, variance, Special Exception, or other approval.
    - iv) Not meeting the conditions or commitments of a Special Exception, variance, rezoning, or other approval whether recorded or not.
    - v) Not meeting the conditions of a Site Development Plan, Planned Unit Development Detailed Plan, or any written commitment associated therewith.
    - vi) Illegal use or illegal expansion of use of structures, or structures and land in combination.
- 2) MEMORANDUM OF AGREEMENT. The Director must meet with the person(s) served the Stop-Work Order notice within seven (7) days of any such meeting being requested. A Memorandum of Agreement shall be drafted stating the conditions by which construction or action may be resumed. This Memorandum of Agreement must be signed by the Director and the property owner responsible for the violation.
- 3) APPEALS. Any Stop-Work Order issued as a result of the enforcement of this Ordinance, may be appealed to the Zoning Board of Adjustment. This appeal shall follow the provisions established in *Section 11.11 - Administrative Appeals Procedure* of this chapter.
- 4) Resumption of Construction Activities. The Stop-Work Order shall be lifted and construction activity may resume upon either:
  - a) The resolution of the violation(s) to the satisfaction of the Director; or
  - b) The execution of all tasks required by the Memorandum of Agreement.

**Sec. 12.04 – IMMEDIATE PUBLIC RISK VIOLATIONS**

---

- 1) GENERAL REQUIREMENTS. Any violation of this Ordinance that presents an immediate risk to the health, safety, or welfare of the public or to property within The City of Dallas may be corrected by the Director, or a person, firm, or organization selected by the Director without prior notice to the

property owner or other person responsible for the violation.

- 2) IMMEDIATE PUBLIC RISK VIOLATION DEFINED. Immediate Public Risk violations shall include but not limited to:
  - a) Obstructions. Signs, structures, landscaping or other materials placed in an easement, sight visibility triangle, or other non-public right-of-way in violation of this Ordinance;
  - b) Distractions. Any sign, structure, landscaping, or other material located on private property that serves to distract or inhibit operators of motor vehicles on adjacent public streets, pedestrians, or other members of the general public; and
  - c) Other Threats. Any other immediate threat to public welfare as determined by any representative of The City of Dallas, or by the City Council based upon the advice and recommendation of the Director.
- 3) NOTICE OF VIOLATION. The Director shall provide notice to the owner of the property, as listed in the records of the County Recorder's Office, upon which the violation was located, or any discernible appropriate owner of materials placed within the right-of-way in violation of this Ordinance, by placing a notice in a conspicuous place on the property and by mailing a letter to that property owner.
  - a) Notice Contents. The letter and posted notice shall include the following:
    - i) A citation of the section(s) of the Ordinance that were violated and the characteristic(s) of the violation that posed an immediate threat to public welfare; and
    - ii) The address and phone number of the Director and the name of the person to be contacted by the property owner to discuss the violation.
- 4) LIABILITY. Neither the Director, The City of Dallas, nor any other official or entity involved in the seizure of items in violation of this Zoning Ordinance shall be liable for any damage to the seized materials or the property from which they were taken.

#### **Sec. 12.05 – TRIAL FOR VIOLATIONS**

---

- 1) PROCEDURE. A person who receives a notice of violation may elect to stand trial for the offense by indicating on the notice of violation his intent to stand trial and returning a copy of the notice of violation to the issuing agency. The returned copy of the notice of violation shall serve as notice of the person's intent to stand trial, and additional monetary fines prescribed in *Section 12.06 – Monetary Fine and Penalties* shall be stayed upon receipt of the notice. Depending on the nature of the infraction, the City may issue a citation for a violation of the ordinance and send the offending party to Municipal Court for adjudication.
- 2) CIVIL REMEDIES. If a person who receives a notice of violation fails to remedy the situation on their own, and fails to give notice of his intention to stand trial as prescribed in this section, The City of Dallas, the City Council on behalf of the City or any officer designated by the City Council on behalf of the City may file suit for injunction against any violation of this Zoning Ordinance, or if the violation has caused damages to the City for a judgment for damages and any person, property owner or occupant of property who can show that the person, property owner or occupant of property has suffered harm or whose property has suffered harm as a result of violations of this Zoning Ordinance may file suit for injunction or damages to the fullest extent provided by the law.
- 3) COURT COST AND FEES. A person adjudged to have committed a civil zoning violation is liable for the

court costs and fees. No cost shall be assessed against the enforcement agency in any such action.

- a) Burden. In proceedings before the court for a civil zoning violation, the *Georgia Civil Practice Act embodied in O.C.G. A. 9-11-1 et. seq.*, shall govern. The designated enforcement entity has the burden of proving the civil zoning violation by a preponderance of the evidence.
- b) Relief or Remedy. Seeking a civil penalty as authorized by this section does not preclude the City from seeking alternative relief from the court in the same action, or from seeking injunctive relief or other remedy in a separate action for the enforcement of this Ordinance.
- c) Change of Venue. If the City is successful in an action brought under this section, the respondent shall bear the costs of the action. A change of venue from the County Superior Court may not be granted in such an action.

**Sec. 12.06 – MONETARY FINE AND PENALTIES**

---

- 1) **APPLICABILITY**. Any person who uses property in violation of the Zoning Ordinance of City of Dallas shall be deemed to have committed a civil zoning violation and may receive a notice of violation by the Dallas Code Enforcement division.
- 2) **FINE**. A separate offense shall be deemed committed each day upon which a violation occurs or continues and may be subject to a fine of two-thousand five-hundred dollars (\$2,500.00) per violation.
- 3) **ACCOUNTABILITY**. The owner or tenant of any building, structure, premises, or part thereof, and any architect, builder, contractor, realtor, agent, or other person who commits, participates in, assists in, or maintains such violation may each be found guilty of a separate offense and suffer the penalties herein provided.
- 4) **COST OF ATTORNEY, INVESTIGATION, AND OTHER FEES**. If the City of Dallas is required to utilize the services of an attorney in investigating a possible violation of this Ordinance or in enforcing the provisions of this Ordinance pursuant to this section or any other Section; and such investigation results in a determination that a violation has occurred, or if the City Council or City is successful in its enforcement of the Ordinance by way of suit, appeal or other appropriate proceeding; the respondent, defendant or party investigated for a violation shall pay the City's reasonable attorney fees and all costs related to the investigation of the violation and/or the enforcement of this Ordinance, unless such attorney fees or the costs are specifically waived by the Dallas City Council.
- 5) **WAIVING FINES**. The Community Development Director may, at his/her discretion, waive the assessed fine for timely correction of the violation.

Figure 12.1: Code Compliance Process – City of Dallas



---

**CHAPTER XIII – DEFINITIONS**

---

- A -

**ABANDONMENT:** The relinquishment of property or a cessation of the use of the property by the owner with the intention neither of transferring rights to the property to another owner nor of resuming the use of the property.

**ABUT OR ABUTTING:** To physically touch or border upon; or to share a common property line.

**ACCESS ROAD:** A street designed to provide vehicular access to abutting property and to discourage through traffic.

**ACCESSIBLE ELECTRIC VEHICLE CHARGING STATION:** An electric vehicle charging station where the battery charging station is located within accessible reach of a barrier-free access aisle and the electric vehicle to enable access by disabled persons.

**ACRE:** A measure of land area containing forty-three thousand five-hundred and sixty (43,560) square feet.

**ACREAGE, GROSS:** The total area within a parcel of land.

**ADDITION (to an existing structure):** Any construction that increases the size of a structure in terms of site coverage, floor area, volume, and/or height. Any walled and roofed expansion to the perimeter of a structure in which the addition is connected by a common load-bearing wall other than a firewall.

**ADJACENT:** To be separated by common property lines, lot lines, right of way or an alley.

**AGRICULTURAL ROADSIDE STAND:** A removable, temporary structure, not permanently affixed to the ground, used or intended to be used solely by the owner or the tenant of a property on which it is located for the sale of seasonable agricultural products produced on the premises and to be removed and stored behind the front building line of the property at the conclusion of the seasonal sales. No roadside stand shall be more than three-hundred (300) square feet in ground area and there shall not be more than one roadside stand on any one premise.

**AGRICULTURAL STRUCTURE:** A structure located on agriculturally used property and designed and constructed to house farm implements, livestock, hay, grain, fruit, and/or other agricultural products, supplies, and equipment used by the operators of the agricultural use. An agriculture structure shall not include dwellings or structures used for the processing, treating, or packaging of agricultural products, or by the public.

**AGRICULTURAL USE, LOW INTENSITY:** Farming, including but not limited to plowing, tillage, cropping, installation of best management practices, seeding, cultivating, or harvesting for the production of food and fiber products (excluding commercial logging and timber harvesting operations); the grazing or raising of livestock (excluding CAFO and CFO operations); Aquaculture; orchards; viticulture (vineyard); Christmas tree farms; and agricultural roadside stands.

**AIR POLLUTION:** Presence in the outdoor atmosphere of one or more air contaminants in sufficient quantities and of characteristics and duration that are injurious to human, plant, or animal life, to property, or which unreasonably interfere with the comfortable enjoyment of life and property.

**AISLE:** The traveled way by which cars enter and depart parking spaces.

**ALLEY:** A right-of-way, other than a street, road, crosswalk, or easement, designed to provide a secondary means of access for abutting properties.

ALTERATION: Any change, addition, or modification in construction or use of an existing structure or property.

ALTERATION, STRUCTURAL: Any change in the supporting members of a building such as bearing walls, columns, beams, foundations or girders.

AMENITY: A natural or man-made feature that enhances or makes more attractive or satisfying a particular property.

ANIMAL: Any live vertebrate creature, domestic or wild, excluding human beings.

- 1) Exotic Animal: Any animal not identified in the definition of “animal” provided in this part that is native to a foreign country or of foreign origin or character, and is not native to the United States, or was introduced from abroad. This term specifically includes animals such as, but not limited to, lions, tigers, leopards, elephants, camels, antelope, anteaters, kangaroos, and water buffalo, and species of foreign domestic cattle, such as Ankole, Gayal, and Yak.
- 2) Farm Animal: Any domestic species of cattle sheep, swine, goats, llamas, horses, or poultry which are normally and have historically, been kept and raised on farms in the United States, and used or intended for use as food or fiber, for improving the quality of food or fiber, or for transportation. This term also includes animals such as rabbits, mink, and chinchilla, when they are used solely for purposes of meat or fur, and animals such as horses and llamas.
- 3) Pet Animal: Any animal that has commonly been kept as a pet in family households in the United States, and is cared for and treated in a manner acceptable for pet dogs, cats, guinea pigs, rabbits, hamsters, and birds. This term excludes exotic animals and wild animals.
- 4) Wild Animal: Any animal which is now or historically has been found in the wild, or in the wild state, within the boundaries of the United States, its territories, or possessions. This term includes, but is not limited to, animals such as deer, skunk, opossum, raccoon, mink, armadillo, coyote, squirrel, fox, and wolf.

ANIMAL BOARDING AND STABLES (excluding kennels): Any structure, land, or combination thereof used, designed, or arranged for the boarding, breeding, or care of dogs, cats, fowl, horses, or other similar domesticated animals for profit, but exclusive of animals used for agricultural purposes.

ANIMAL SHELTER: A facility used to care for and house lost, stray, homeless, abandoned, or unwanted animals; including those found running at-large or otherwise subject to impoundment consistent with applicable laws. Animal shelter includes facilities for adoption, medical treatment, and cremation.

ANTENNA: Any system of wires, poles, rods, reflecting discs, or similar devices used for the purpose of receiving and/or transmitting signals, images, sounds, or information of any nature by radio, visual, or electromagnetic waves, including but not limited to directional or omni-directional antennas, panels, and microwave or satellite dishes external to, or attached to, the exterior of any building.

APPEAL: A request for a review of the Director’s interpretation of any provision of this Ordinance.

APPLICANT: The owner of real estate or an appointed agent of an owner, who makes application to the City of Dallas Community Development Department for action by the Dallas Planning & Zoning Commission or City Council.

APPLICATION: The completed form or forms, together with any other required materials, exhibits, and fees required of an applicant consistent with the procedures established by this Ordinance.

APPURTENANCE: A minor element of a larger structure, such as a bay window, stairs, light post, etc.

ARBORIST: An individual trained in arboriculture, forestry, landscape architecture, horticulture, or related fields and experienced in the conservation and preservation of trees.

ASSEMBLY FACILITY: A building or portion of a building in which facilities are provided for group civic, educational, political, professional, religious, cultural, or social functions.

ASSISTED LIVING FACILITY: A multiple family structure, controlled either by a public body, institutional body, or nonprofit corporation, a majority of whose occupants shall be sixty-five (65) years of age or over, or a multiple family structure where each unit is occupied by at least one person who is fifty-five (55) years of age or over and is retired, and where the rental arrangement includes primarily non-medical services dealing with the instrumental activities of daily living such as dressing, grooming, bathing, etc.

AUCTION FACILITY (excluding livestock): A building or property used for the storage of goods and materials that are to be sold on the premises by public auction, and for the sale of the said goods and materials by public action on an occasional basis only.

AWNING: Any structure made of cloth, metal, or glass with a frame attached to a building and projecting over a window, sidewalk, or door, when the same is so erected as to permit its being raised or retracted to a position flat against the building when not in use.

- B -

BALCONY: A platform that projects from the wall of a building and is surrounded by a railing or parapet.

BANQUET HALL: An establishment which is rented by individuals or groups to accommodate private functions including, but not limited to, banquets, weddings, anniversaries and other similar celebrations. Such a use may or may not include: 1) kitchen facilities for the preparation or catering of food; 2) the sale of alcoholic beverages for on-premise consumption, only during scheduled events and not open to the general public; and 3) outdoor gardens or reception facilities.

BASEMENT: A story all or partly underground but having at least one-half ( $\frac{1}{2}$ ) of its interior height below the average finished grade adjoining ground. A basement shall not be counted as a story for the purpose of height regulations unless it has been subdivided into rooms and used for tenant purpose.

BATTERY CHARGING STATION: An electrical component assembly or cluster of component assemblies designed specifically to charge batteries within electric vehicles.

BATTERY ELECTRIC VEHICLE: Any vehicle that is licensed and registered for operation on public and private highways, roads, and streets; either partially or exclusively, on electrical energy from the grid, or an off-board source, that is stored on-board via a battery for motive purpose. Any vehicle that operates exclusively on electrical energy from an offboard source that is stored in the vehicle's batteries, and produces zero tailpipe emissions or pollution when stationary or operating.

BEACON: Any light with one or more beams directed into the atmosphere or directed at one or more points not on the same zone lot as the light source; also, any light with one or more beams that rotate or move.

BERM: A man-made mound of earth of definite height and width used for landscaping and obscuring purposes.

BLOCK: A unit of property bounded by street rights-of-way, railroad rights-of-way, or waterways.

**BOARDING HOUSE:** An establishment offering rooms for rent, where meals are regularly served from a single kitchen (not open to the general public) for compensation for three (3) or more persons, but not exceeding twelve (12) persons. Boarding houses do not include bed and breakfasts, multifamily dwellings, hotels, or motels.

**BREWERY:** A manufacturer or producer of malt beverages for wholesale off the premises but does not include a brewpub as that term is defined in this section. Typical brewing production is greater than 15,000 barrels per year.

**BREWERY, MICRO:** A manufacturer or producer of malt beverages for wholesale off the premises limited to no more than 15,000 barrels per year.

**BREWERY, NANO:** A manufacturer or producer of malt beverages for wholesale off the premises limited to no more than 2000 barrels per year.

**BREWERY, PUB:** Brewpub means a restaurant in which beer or malt beverages are manufactured or brewed, subject to the barrel production limitation prescribed in O.C.G.A. § 3-5-36 for retail consumption on the premises and solely in draft form.

**BUFFER YARD:** An area adjacent to front, side and/or rear property lines, measured perpendicularly from adjacent property lines and/or right-of-way lines, intended to visibly separate one use from another through the use of trees, shrubs, walls, fences, berms, other related landscaping features. Buffer yards are intended to: help maintain existing trees or natural vegetation; maintain privacy; or to shield / block sound, noise, light, odor, chemicals, or other nuisances. Buffer yards can exist in the same horizontal space as front, side, and rear setbacks provided that the largest setback distance shall be met.

**BUILD-TO LINE:** A line parallel to the front property line indicating the distance from the front property/right-of-way line at which principal structures must be built. A built-to line is neither a minimum or a maximum, but rather a specific requirement. Front porches and handicap ramps shall be exempt from build-to line requirements, and must occur behind the property line.

**BUILDABLE AREA:** The three dimensional portion of a lot remaining after the setback, easement, buffers, maximum height, landscaping, or open space requirements of this Ordinance have been met. Also referred to as “Building Envelope.”

**BUILDING:** Any structure that is primarily above ground and enclosed, having a roof supported by columns or walls and intended for the shelter, housing or enclosure of any persons, property, or animals. When separated by division walls from the ground up and without openings, each portion of such building may be deemed as a separate building.

**BUILDING, ACCESSORY:** A subordinate building or structure on the same property or on an approved property as the principal building or structure.

**BUILDING, ATTACHED:** A building that is structurally connected to another building by a foundation, wall, or roof line.

**BUILDING CODE:** The City Ordinance establishing and controlling the standards for constructing buildings, utilities, mechanical equipment and all forms of structures and permanent installations and related matters within the City.

**BUILDING, DETACHED:** A building having no structural connection with another building.

**BUILDING, FRONT LINE OF:** The line of the face of the building nearest the front Lot Line.

**BUILDING INSPECTOR:** That individual designated by the Community Development Director to enforce the provisions of the building code.

**BUILDING, PRINCIPAL:** The building or structure in which is conducted the principal use of the lot on which it is located. Where a substantial part of an accessory building is attached to the principal building in a substantial manner, as by a roof, such accessory building shall be counted as a part of the principal building. Standards recognized by the Indiana Department of Fire and Building Services shall be used to determine whether a given structure constitutes one (1) or more buildings in cases where ambiguities exist.

**BUILDING, PRINCIPAL:** The main building or structure on a single lot or parcel of land and includes any attached garage or attached porch.

**BUS OR TRAIN TERMINAL:** A centralized and/ or primary community facility for the transient housing or parking of motor driven buses, trains, or similar mass transit modes of transportation, and the loading and unloading of passengers.

**BUSINESS, COMMERCIAL SERVICE:** Establishments that primarily render services rather than goods. Such services may include, but not be limited to, copy shops, printing services, photo processing, barber and beauty shops, dance/ martial arts/gymnastics studios, salon, nail and tanning.

**BUSINESS, RETAIL:** Any business selling goods, wares or merchandise directly to the ultimate consumer for direct consumption and not for resale. A retail business use includes, but need not be limited, to such activities as: supermarkets or stores that sell hardware, apparel, footwear appliances, furniture, department stores, and discount stores. Also includes the maintenance or operation of offices.

**BUSINESS, RETAIL, SMALL SCALE:** Any retail business that is less than fifteen-thousand (15,000) square feet in floor area. This use may include, but shall not be limited to: antique shop, flower shop, grocery store / supermarket, jewelry store, news dealer / bookstore, office supply store, pharmacy, print shop / copy center, shopping centers ( $\geq 15,000$ sf), and video/music store.

**BUSINESS, RETAIL, MEDIUM SCALE:** Any retail business that is greater than fifteen-thousand ( $\leq 15,000$ ) square feet, but less than thirty-five thousand (35,000) square feet in floor area. This use may include, but shall not be limited to: building supply store, department store, home electronics / appliance store, manufactured home sales, and nursery (retail and wholesale).

**BUSINESS, RETAIL, LARGE SCALE:** Any retail business that is greater than thirty-five thousand (35,000) square feet in floor area. Includes “big box” stores, superstores, and department store bulk sales. This use may include, but shall not be limited to: “big box” stores, superstores, department store bulk sales, or mall/outlet shopping centers.

**BUSINESS, WHOLESALE:** A business establishment that generally sells commodities in large quantities or by the piece to retailers, jobbers, other wholesale establishments, or manufacturing establishments. The commodities are basically for future resale, for use in the fabrication of a product or for use by a business service.

**BUSINESS/FINANCIAL SERVICES OFFICE:** Any office where the primary occupation is concerned with such federal or state-regulated businesses as banking, savings and loans, loan companies, and investment companies.

**BUSINESS, SEXUALLY-ORIENTED:** Adult arcade, adult bookstore, adult novelty store, adult video store, adult cabaret, adult motel, adult motion picture theater, adult theater, escort agency, nude modeling studio, sexual encounter center, or massage parlor.

- C -

**CAMPUS:** An area of land constituting and making up the grounds of an institution, such as a college or university, a business complex, or a manufacturing park.

**CANOPY:** Any structure, other than an awning, made of cloth or metal with frames attached to a building, projecting over a sidewalk.

**CANOPY, GASOLINE ISLAND:** Any structure made of metal with frames attached to the ground or a building, that projects over gasoline islands or pumps.

**CAR WASH:** A building or part of a building containing facilities for washing more than two (2) automobiles within self-service open bays, or using production-line methods with a chain conveyor, blower, steam cleaning device or other mechanical device and which may include on the same site the fueling of automobiles when such fueling is ancillary and preliminary to the principal function of washing vehicles.

**CARPORY:** A covered automobile parking space not completely enclosed by walls or doors.

**CEMETERY:** Land used or intended to be used for the burial of the animal or human dead and dedicated for cemetery purposes, including crematories, columbariums, mausoleums, and mortuaries if operated in connection with and within the boundaries of a cemetery.

**CERTIFICATE OF COMPLETION:** A required certificate for any non-roofed structure, including but not limited to signs and pools, that allows use of the structure after it has been determined that the structure meets all of the requirements of applicable ordinances.

**CERTIFICATE OF OCCUPANCY:** A required certificate allowing occupancy or use of a building or structure after it has been determined that the building or structure meets all the requirements of applicable City and County codes and ordinances, and state and federal regulations.

**CHANGE OF USE:** Any use which substantially differs from the previous use of a building or parcel of land.

**CHARGING LEVELS:** The standardized indicators of electrical force, or voltage, at which an electric vehicle's battery is recharged. The terms 1, 2, and 3 are the most common charging levels, and include the following specifications:

- 1) Level-1 is considered slow charging. Voltage including the range from 0 through 120.
- 2) Level-2 is considered medium charging. Voltage is greater than 120 and includes 240.
- 3) Level-3 is considered fast or rapid charging. Voltage is greater than 240.

**CLUSTER DEVELOPMENT:** A development design technique that concentrates buildings/ structures in specific areas on a site to allow the remaining land to be used for recreation, common open space, and/or preservation of historic or environmentally sensitive features.

**COMMON AREA:** Land within a development which is not individually owned or dedicated to the public, but which is designed and intended for the use, enjoyment, and maintenance of the property owners within that development or other specific area. The common area may include complimentary structures and/or other improvements.

**COMMUNICATIONS SERVICE EXCHANGE:** A telecommunications facility that houses one or more computer systems and related equipment dedicated to building, maintaining, and/or processing data. Such a facility would likely include a telephone service exchange, a data center, and a server farm.

**COMPATIBLE:** Having harmony and consistency in design, function, and/or appearance.

**COMPREHENSIVE PLAN:** A plan adopted by the Dallas City Council showing the general location and extent of present and proposed physical facilities including residential, industrial and commercial uses, major streets, parks, schools and other community facilities. This plan establishes the goals, objectives, and policies for the physical development of the City.

**CONCEPT PLAN:** An illustration of the layout of a proposed planned unit development, required prior to a PUD rezoning consideration, and prior to the filing of a Preliminary Plan for a PUD or a Primary Plat for a subdivision.

**CONDITION OF APPROVAL:** Stipulations or provisions set forth as a prerequisite for approval of an application.

**CONDOMINIUM:** Real estate lawfully subject to *O.C.G.A Chapter 3, Article 3*, as amended: Condominiums by the recording of condominium instruments, in which undivided interests in the common areas and facilities are vested in the condominium unit owners. Also, a form of property ownership providing for individual ownership of space in a structure together with an individual interest in the land or other parts of the structure in common with other owners.

**CONSTRUCTION, ACTUAL:** Work done which is beyond the preparation stage and into that stage where the changes or additions are made permanent. Actual construction includes the placing of construction materials in a permanent position and fastened in a permanent manner. Where demolition or removal of an existing building has been substantially begun preparatory to rebuilding, such demolition or removal shall be deemed to be actual construction, provided that the work shall be carried out diligently.

**CONSTRUCTION, NEW:** Any walled and roofed addition, which is connected by a firewall or is separated by independent perimeter load-bearing walls, is new construction.

**CONSTRUCTION, START OF:** The date the building permit was issued, provided the actual start of construction, repair, reconstruction, or improvement was within one-hundred eighty (180) days of the permit date. The actual start means the first placement or permanent construction of a structure (including a manufactured home) on a site, such as the pouring of slabs or footing, installation of piles, construction of columns, or any work beyond the stage of excavation for placement of a manufactured home on a foundation. Permanent construction does not include land preparation, such as clearing, grading and filling; nor does it include the installation of streets and/or walkways; nor does it include excavation for a basement, footings, piers, foundations, or the erection of temporary forms; nor does it include the installation on the property of accessory buildings, such as garages or sheds not occupied as dwelling units or not part of the main structure. For substantial improvement, the actual start of construction means the first alteration of any wall, ceiling, floor, or other structural part of a building, whether or not that alteration affects the external dimensions of the building.

**CONSTRUCTION TRAILER:** A manufactured mobile unit without cooking or bathroom facilities, not designed for dwelling purposes, and used as a temporary office during construction.

**CONSTRUCTION PLANS:** Drawings that detail the specific location and design of utilities, streets, and other improvements.

**CONVALESCENT CARE/NURSING HOME:** A home, licensed by the state, for the aged or chronically or incurably ill persons in which five (5) or more persons not of the immediate family are provided with food and shelter or care for compensation, but not including hospitals, clinics or similar institutions devoted primarily to the diagnosis and treatment of the sick or injured.

COVENANTS: Private and legal restrictions of various kinds on the usage of lots, typically within a subdivision and applied by the developer, that are recorded with the plat and deed. Covenants are enforceable in civil court by interested or affected parties.

CREMATORY: A building or structure containing one or more cremation chambers or retorts for the cremation of dead human bodies or large animals and "large animals" means all cattle, horses, sheep, goat, swine or similar species commonly kept as livestock.

CROSSWALK: A strip of land dedicated to public use, which is reserved across a block to provide pedestrian access to adjacent areas.

CURB: A concrete boundary marking the edge of a street or other paved area and providing for a change in grade between the street surface and the adjacent unpaved portions of the street right-of-way.

CURB CUT: The providing of vehicular ingress and/or egress between property and an abutting public street.

CURB RADIUS: The curved edge of a street, driveway, or other paved area at an intersection with another street, driveway, or other paved area.

CUT: An excavation. The difference between a point on the original ground and a designated point of lower elevation on the final grade. Also, the material removed in excavation.

- D -

DAY CARE CENTER (child/adult): As defined by Georgia Law, and for the purposes of this Zoning Ordinance, a non-residential building where at least one (1) child or adult receives care from a provider:

- 1) While unattended by a parent, legal guardian, or custodian;
- 2) For regular compensation; and
- 3) For more than four (4) hours but less than twenty-four (24) hours in each of ten (10) consecutive days per year, excluding intervening Saturdays, Sundays, and holidays.

DAY CARE HOME (child/adult): As defined by Georgia Law, and for the purposes of this Zoning Ordinance, a residential structure in which at least six (6) children or adults (not including those for whom the provider is a parent, stepparent, guardian, custodian, or other relative or any child who is at least fourteen (14) years of age and does not require child care) at any time receive care from a provider:

- a) While unattended by a parent, legal guardian, or custodian;
- b) For regular compensation; and
- c) For more than four (4) hours but less than twenty-four (24) hours in each of ten (10) consecutive days per year, excluding intervening Saturdays, Sundays, and holidays.

DEALERSHIP OUTDOOR DISPLAY AREA: An area of designated size for the placement of automobiles, recreational vehicles, motorcycles, trucks, trailers and farm implements, new or used for sale outside of the building or structure. This does not include areas to be designated for customer & employee parking or service areas.

DECK: A platform, either freestanding or attached to building that is supported by pillars or posts.

DECIBEL: A unit of measurement of the intensity of loudness of sound. Sound level meters are used to measure such intensities and are calibrated in decibels.

DENSITY: A unit of measurement that indicates the number of units per acre of land.

- 1) Gross Density: A number of units per acre of the total land to be developed, including public rights-of-way and dedicated open space.
- 2) Net Density: A number of units per acre of land when the acreage involved includes only the land devoted to intended uses and common open space, and excluding public rights-of-way and dedicated open space.

DESIGN: A planned arrangement of forms, shapes, massing, colors, and materials intended to serve a useful purpose or be decorative or artistic. The essence of a design resides not in the elements individually, nor in their method of arrangement, but in the total ensemble that awakens some sensation in the observer's mind.

DESIGNATED ENFORCEMENT ENTITY: The board, commission, person, or other entity charged with enforcing a violation of the Zoning Ordinance.

DETACHED STRUCTURE: A building that has no structural connection with the principal structure.

DEVELOPER: An individual, partnership, corporation (or agent thereof), or other entity that undertakes the responsibility for land development, particularly the designing of a subdivision plat or site Development Plan showing the layout of the land and the public improvements involved therein.

DEVELOPMENT: Any man-made change to improved or unimproved real estate including but not limited to:

- 1) Construction, reconstruction, or placement of a building or any addition to a building;
- 2) Installing utilities, erection of walls, construction of roads, or similar projects;
- 3) Construction of flood control structures such as levees, dikes, dams, or channel improvements;
- 4) Mining, dredging, filling, grading, excavation, or drilling operations;
- 5) Construction or reconstruction of bridges or culverts;
- 6) Storage of materials; or
- 7) Any other activity that might change the direction, height, or velocity of flood or surface waters.
- 8) Development does not include activities such as the maintenance of existing buildings and facilities such as painting, re-roofing, resurfacing roads, or gardening, plowing and similar agricultural practices that do not involve filling, grading, excavation, or the construction of permanent buildings.

DEVELOPED PARCEL: A fully developed parcel or lot is a parcel of land with an existing development or use that is of a size that is within the range of density or intensity permitted within the underlying zoning classification, is generally similar in size to other developed parcels or lots within the immediate vicinity, and does not qualify within the definition of an undeveloped or underdeveloped parcel or lot. Any lot or parcel with an existing residential development or use that is below 8,500 square feet shall be classified as fully developed.

DEVELOPMENT PLAN: Also referred to as Site Development Plan or Site Plan. A detailed, dimensioned plan that illustrates the proposed development or alterations of a site, which would normally include architectural, engineering, landscape architectural, lighting and signage plans, prepared in accordance with the rules and regulations of the City of Dallas, and submitted to the Planning & Zoning Commission or other designated body or authority for review and approval.

**DEVELOPMENT PLAN REVIEW:** A process through which adaptive reuse, new development, and structural/site expansions of more than thirty (30%) percent for all multifamily, commercial or industrial development, and major residential subdivisions must proceed according to the provisions of this Zoning Ordinance.

**DEVELOPMENT STANDARDS:** Regulations provided by this Ordinance that provide specific conditions for the development and use of buildings/structures and property.

**DISTANCE BETWEEN STRUCTURES ON SAME LOT, MINIMUM:** This distance, measured between the points of shortest distance on the exterior facades of two (2) structures, shall determine the minimum separation of multiple structures within one (1) developed lot.

**DISTRICT:** An area with common social, physical, economic, or land use characteristics.

**DRIVE-IN FACILITY:** Any portion of a building or structure from which business is transacted or is capable of being transacted directly with customers located in a motor vehicle during such business transactions.

**DRIVEWAY:** A private roadway providing access for vehicles to a parking space, garage, dwelling or other structure intended for motor vehicle access.

**DRIVEWAY, COMMON:** An access shared by adjacent property owners.

**DWELLING:** Any building, or portion of a building, which is designed or used primarily for residential purposes, including single-family, two-family and multifamily; but not including hotels, motels, boarding houses, lodging houses and tourist housing. Any building or part of a building containing living, sleeping and housekeeping accommodations, and sanitary facilities for occupancy by one (1) or more families.

**DWELLING, ACCESSORY APARTMENT:** A dwelling unit designed for and occupied by one (1) family or single unit of housekeeping, and secondary to a principal use of the property, for use as a complete, independent living facility with provision in the accessory apartment for cooking, eating, sanitation, and sleeping. Accessory apartments shall be clearly subordinate to the principal use in both size and location.

**DWELLING, APARTMENT:** A dwelling unit in a structure arranged, intended, designed, or occupied on a rental basis for the housing of a single-family, an individual, group of individuals, or other single housekeeping unit.

**DWELLING, MANUFACTURED HOME/MOBILE HOME:** As defined in *42 USC 5402*, and for the purposes of this Ordinance, a structure, transportable in one or more sections, which, in the traveling mode, is eight (8) body feet or more in width or forty (40) body feet or more in length, or, when erected on site, is three-hundred twenty (320) or more square feet, and which is built on a permanent chassis and designed to be used as a dwelling with or without a permanent foundation when connected to the required utilities, and includes the plumbing, heating, air-conditioning, and electrical systems contained therein; except that such term shall include any structure which meets all the requirements of this paragraph except the size requirements and with respect to which the manufacturer voluntarily files a certification required by the Secretary and complies with the standards established under this chapter; and except that such term shall not include any self-propelled recreational vehicle.

**DWELLING, MULTI-FAMILY:** A building consisting of three (3) or more dwelling units, including condominiums, with varying arrangements of entrances and party walls. Individual kitchen/ dining and restroom/bathing facilities shall be provided in each separate dwelling unit. Multifamily housing may include public housing and industrialized units. The number of families and housekeeping units in residence not exceeding the number of dwelling units provided.

DWELLING, SINGLE FAMILY, ATTACHED: Single-family units, not more than three (3) in any one (1) building, which are physically attached, one to another, by a combination of common or adjoining vertical walls or floors which have individual heating and plumbing systems. Includes two-family dwellings.

DWELLING, SINGLE FAMILY: A building containing one (1) dwelling unit and that is not attached to any other dwelling by any means and is surrounded by open space or yards. This definition includes Manufactured Homes that are approved under *2010 Georgia Code Title 8 –Chapter2: Buildings and Hosing*.

DWELLING SITE: A site within a manufactured home park with required improvements and utilities that is leased for the long term placement of manufactured homes.

DWELLING, TWO-FAMILY: A building consisting of two (2) dwelling units which may be either attached side by side, or one above the other; and each unit having a separate or combined entrance or entrances from the outside of the building.

DWELLING UNIT: A room or group of rooms designed and equipped exclusively for use as living quarters for only one (1) family and its household employees, including sleeping, cooking, and sanitary facilities. The term shall include manufactured homes but shall not include recreational vehicles.

- E -

E.I.F.S.: Acronym for Exterior Insulation Finishing System, a construction siding material.

EASEMENT: Authorization by a property owner for the use of a designated part of the subject property by specific persons, the general public, corporations, utilities, or others, for a specified purpose, of any.

EDUCATIONAL INSTITUTIONAL, EXCLUDING P-12, PUBLIC/PRIVATE: Examples may include trade schools, learning academies, defensive driving schools, self-defense, martial arts, colleges and universities.

EGRESS: An exit.

ELECTRIC VEHICLE: Any vehicle that is licensed and registered for operation on public and private highways, roads, and streets; either partially or exclusively, on electrical energy from the grid, or an off-board source, that is stored on-board via a battery for motive purpose. "Electric vehicle" includes: (1) a battery electric vehicle; and (2) a plug-in hybrid electric vehicle.

ELECTRIC VEHICLE CHARGING STATION: A public or private parking space that is served by battery charging station equipment that has as its primary purpose the transfer of electric energy (by conductive or inductive means) to a battery or other energy storage device in an electric vehicle. An electric vehicle charging station equipped with Level-1 or Level-2 charging equipment is permitted outright as an accessory use to any principal use.

ELECTRIC VEHICLE CHARGING STATION – private restricted use: An electric vehicle charging station that is (1) privately owned and restricted access (i.e., single-family home, executive parking, designated employee parking) or (2) publicly owned and restricted (i.e., fleet parking with no access to the general public).

ELECTRIC VEHICLE CHARGING STATION – public use: An electric vehicle charging station that is (1) publicly owned and publicly available (i.e., commuter parking, public library parking lot, on-street parking) or (2) privately owned and available to visitors of the use (i.e., shopping center parking).

ELECTRIC VEHICLE INFRASTRUCTURE: Conduit/wiring, structures, machinery, and equipment necessary and integral to support an electric vehicle, including battery charging stations and rapid charging stations.

ELECTRIC VEHICLE PARKING SPACE: Any marked parking space that identifies the use to be exclusively for the parking of an electric vehicle.

**ELECTRONIC VARIABLE MESSAGE SIGNS (EVMS):** A sign, or component of a sign, such as an electrically or electronically controlled message center, where the characters, letters, or illustrations can be changed or rearranged either in the field, or from a remote location, without physically altering the face or the surface of the sign.

**ELEVATION:** A flat scale drawing of the front, rear, or side of a building.

**ENLARGEMENT:** An increase in size of an existing structure or use.

**ESSENTIAL SERVICES, MAJOR:** Services of a regional nature that normally entail the construction of new buildings or structures such as generating plants and sources, electrical switching facilities, and stations or substations, community waste water treatment plants, and similar facilities. Included in this use type are also electric, gas, and other utility transmission lines of a regional nature that are not otherwise reviewed and approved by the state and all overhead service, distribution and transmission lines.

**ESSENTIAL SERVICES, MINOR:** Services that are necessary to support development within the immediate vicinity and that involve only minor structures. Included in this use type are small facilities such as transformers, relay and booster devices, and well, water and sewer pump stations. Also included are wireless telecommunication antennas attached to an existing building or structure, including but not limited to utility poles, signs, broadcasting or communication facilities, and water towers, and that do not increase the height of such building or structure by ten (10) feet.

**EXCAVATION:** Any act by which earth, sand, gravel, rock or any other similar material is dug into, cut, quarried, uncovered, removed, displaced, relocated or bulldozed. Shall also include the conditions resulting therefrom.

- F -

**FACADE:** The portion of any exterior elevation on a building, extending from grade level to the top of the parapet, wall, or eaves for the entire width of the building elevation.

**FAMILY:** Defined as:

- 1) one (1) or more persons related by blood, marriage, adoption or other duly-authorized custodial arrangement; or
- 2) not more than four (4) unrelated persons living together in a dwelling sharing common sleeping, cooking, living, and eating facilities; or
- 3) residents of a Group Home (see "Group Home") licensed by the State of Indiana.
- 4) A family does not include any society, club, fraternity, sorority, group living in a boarding house, hotel, motel, bed and breakfast facility, lodging house, rooming house, assisted living facility, nursing home, or club.

**FAMILY DAY CARE HOME:** Family child care is home-based care provided for a portion of the day in a private family home for compensation. The home must be inhabited by the family/individual who is providing care, and the provider's hours of operation may not exceed eighteen (18) hours in a 24-hour period.

**FARMER'S MARKET:** The seasonal selling at retail of home-grown vegetables or produce, occurring in a pre-designated area, where the vendors are the same individuals who have raised the products for sale.

**FENCE:** Any artificially constructed barrier of any material or combination of materials erected to enclose or screen areas of land.

**FENCE, BARBED-WIRE/RAZOR-WIRE:** One or more strands of wire or other material having intermittent sharp points of wire or metal that may puncture, cut, tear, or snag persons, clothing, or animals.

**FILL:** Any act by which earth, sand, gravel, rock or any other material is placed, pushed, dumped, pulled, transported or moved to a new location above the natural surface of the ground or on top of the stripped surface. Shall also include the conditions resulting therefrom. Also the difference in elevation between a point on the original ground and a designated point of higher elevation on the final grade, or the material used to make a fill.

**FINANCIAL GUARANTEE:** Any cash guarantee which may be accepted in lieu of a requirement that certain improvements be made before the Commission approves the secondary plat.

**FINANCIAL INSTITUTION:** Any building, property or activity of which the principal use or purpose of which is the provision of financial services including but not limited to banks, facilities for automatic teller machines (ATM's), credit unions, savings and loan institutions and mortgage companies.

**FIXTURE, LIGHT:** The assembly that holds the lamp (bulb) in a lighting system. It includes the elements that provide light output control, such as a reflector (mirror) or refractor (lens), the ballast, housing, and the attachment parts.

**FLAG:** Any fabric, banner, or bunting containing distinctive colors, patterns, or symbols, used as a symbol of a government, political subdivision, or other entity.

**FLAT ROOF:** The silhouette formed by a roof line. While the name infers a roof with no pitch, the actual roof structure is required to have a slope for drainage purposes. The roof line can be stepped or flat in appearance by using architectural elements such as cornices, mansards, and parapets.

**FLEA MARKET:** An occasional or periodic sales activity held, for profit, within a building, structure, or open area where groups of individual sellers offer goods new and used, for sale to the public, (not to include private garage sales) in rental spaces for a fee. Flea market shall not include informal garage or yard sales.

**FLEX SPACE:** A building, usually prefabricated, that provides the appearance of a "store front" with a designated use and generally includes an additional use located within the back of a building. Typically, these buildings are designed to be multifunctional containing office or retail space in the front of the building along the "storefront" while other uses including office, retail, warehousing or light manufacturing are located in the rear of the building, hidden by the "store front" use.

**FLOOR AREA, FINISHED:** That portion of floor area constructed, completed, and usable for living purposes with normal living facilities which includes sleeping, dining, cooking, working, entertainment, common space linking rooms, areas for personal hygiene, or combination thereof. Floor area or portion thereof used only for storage purposes and not equipped for the facilities mentioned above shall not be considered Finished Floor Area. The Finished Floor Area of a principal structure does not include a garage, carport, deck, unfinished storage, patio, or open porch.

**FLOOR AREA, GROSS:** The sum of the gross horizontal areas of the several floors of a building measured from the exterior face of exterior walls, or from the center line of a wall separating two (2) buildings. The gross floor area shall not include interior parking spaces, loading space for motor vehicles or any space where the floor to ceiling height is less than six (6) feet.

**FLOOR AREA, GROUND:** The area of a building in square feet, as measured in a horizontal plane at the ground level within its largest outside dimensions, exclusive of open porches, breezeways, terraces, garages, and exterior stairways.

**FLOOR AREA, NET:** The total of all floor area of a building, excluding stairwells and elevator shafts, equipment rooms, interior vehicular parking or loading, and all floors below the first or ground floor, except when used or intended to be used for human habitation or service to the public.

**FLOOR AREA RATIO:** The total floor area of all stories of all buildings or structures on a lot, divided by the total land area of such lot.

**FOUNDATION:** The supporting member of a wall or structure.

**FOUNDATION, PERMANENT:** A structural system, constructed of masonry or poured concrete, for transposing loads from a structure to the earth at a depth below the established frost line without exceeding the safe bearing capacity of the supporting soil.

**FRONTAGE OR BLOCK FRONTAGE:** All property on both sides of a street between two intersecting streets (crossing or terminating) measured along the line of the street, or if the street is dead-ended, then all of the property abutting both sides between an intersecting street and the dead end of the street. Also known as Street Frontage.

**FRONTAGE ROAD:** A road which parallels a major arterial or collector street, providing access from abutting property and separated from the thoroughfare by a common dividing strip.

**FULL CUTOFF:** A light fixture which prevents distribution of light above a horizontal line through the lowest point of the bulb or lens, diffuser, reflective passing enclosure, or other parts intended to distribute light.

**FULLY SHIELDED:** A fixture constructed, installed, and/or mounted so that a line of sight to the bulb is obstructed by an opaque material when viewed at ground level or above from all adjoining residential and public right-of-way property lines and from twenty (20) feet inside all other adjoining property lines.

- G -

**GARAGE, PRIVATE:** A detached accessory building or portion of a principal building for the parking or temporary storage of automobiles, travel trailers or boats of the occupants of the premises. (Not a repair facility.)

**GARAGE, PUBLIC:** A principal building or accessory building other than a private garage, used for parking or temporary storage of passenger automobiles, and, in which, no vehicle sales or service shall be provided for remuneration.

**GARAGE/YARD SALE:** The sale or offering for sale to the general public six (6) or more items of personal property on any portion of a lot in a residential zoning district, either within or outside of a structure.

**GLARE:** The reflection of harsh, bright light producing an effect that causes annoyance, discomfort, or loss of visual performance and visibility.

**GRADE:** The surface of the ground adjacent to the exterior walls of a building.

**GRADING:** Any stripping, cutting, filling, stockpiling or any combination thereof; also the land in its cut or filled condition.

**GRADING PLAN:** The drawing and supporting documents that describe the process and result of the excavating, filling, or leveling of a property by mechanical or other artificial methods.

**GRANDFATHERED:** A description of the status of certain properties, uses, activities, and conditions that were legally existing prior to the effective date of this Ordinance.

**GREEN SPACE AREA:** That portion of the front yard of a lot that is immediately adjacent and parallel to the street right-of-way of the Ronald Reagan Parkway and all other Roads within the identified boundaries.

**GREENHOUSE, COMMERCIAL:** A greenhouse used for the growing of plants, all or part of which are sold at retail or wholesale either on or offsite.

**GROUP HOME:** A residential care facility licensed by the State of Georgia which provides room and board, and personal care and supervision for not more than ten (10) aged, developmentally disabled or mentally ill persons, none of whom has a history of violent or anti-social behavior, who are able to be integrated into a family-type setting.

- H -

**HARDSHIP (as related to variances of this ordinance):** The exceptional hardship that would result from a failure to grant the requested variance. The City Council requires that the variance is exceptional, unusual, and peculiar to the property involved. Mere economic or financial hardship alone is NOT exceptional. Inconvenience, aesthetic considerations, physical handicaps, personal preferences, or the disapproval of one's neighbors likewise cannot, as a rule, qualify as an exceptional hardship. All of these problems can be resolved through other means without granting a variance, even if the alternative is more expensive, or requires the property owner to build elsewhere or put the parcel to a different use than originally intended.

**HAZARDOUS WASTE:** Any refuse, solid waste or combination of solid wastes that, because of its quantity, concentration, or physical, chemical, or infectious characteristics, may:

- 1) Cause or significantly contribute to an increase in mortality or increase in serious irreversible, or incapacitating reversible illness; or
- 2) Pose a substantial present or potential hazard to human health or the environment when improperly treated, stored, transported, disposed of, or otherwise managed.

**HAZARDOUS MATERIAL:** Any substances or materials that by reason of their toxic, caustic, corrosive, abrasive, or otherwise injurious properties, may be detrimental to the health of any person handling or otherwise coming into contact with such material or substance.

**HEALTH CARE FACILITY, MEDICAL OR EMERGENCY:** A facility or institution, whether public or private, used for the care, diagnosis and treatment of sick, ailing, infirm and/or injured persons and those who are in need of medical or minor surgical attention, but who are not provided with board or room, nor kept overnight on the premises.

**HEALTH SPA:** A place or building where active exercise and related activities are performed utilizing weight control or muscle building equipment or apparatus for the purpose of physical fitness. Also a place or building that provides massage, exercise, and related activities with or without such equipment or apparatus.

**HEDGE:** A row of closely planted shrubs, bushes, or any other kind of plant used as a compact, dense, living barrier that protects, shields, separates, or demarcates an area.

HEIGHT: Defined as:

- 1) Structure or Building Height: In all instances, the height of a structure shall be measured from the average elevation of the proposed finished grade to the highest point of the structure. Exemptions are listed in *Section 7.07 – Height Standards*.
- 2) Building Maximum: The maximum allowable vertical distance of a building or structure. Certain height exceptions are permitted according to the provisions of *Section 7.07 – Height Standards*.

HOME BASED-BUSINESS: A business based in the dwelling and/or accessory structures of its owner or operator which results in limited business practices within certain single family residential districts, the scope and character of which is defined by the requirements of the Home Business standards of this Ordinance.

HOME OCCUPATION: A business based in the dwelling of its owner or operator which results in minimal business practices within residential zoning districts, the scope and character of which is defined by the requirements of the Home Occupation standards of this Ordinance.

HOME OWNERS ASSOCIATION: An incorporated non-profit organization operating under recorded land agreements through which each lot owner is automatically a member and each lot is automatically subject to a proportionate share of the expenses for the organization's activities, such as maintaining common property.

HORIZONTAL FOOTCANDLES: The amount of light striking a horizontal plane or surface.

HOSPITAL: Any building or other structure containing beds for at least four (4) patients and devoted to medical diagnosis, treatment or other care of human ailments. Any institution, licensed by the State Department of Health, providing primary health services and medical or surgical care to persons, primarily in-patients, suffering from illness, disease, injury, deformity and other abnormal physical or mental conditions, and including as an integral part of the institution, related facilities such as laboratories, outpatient facilities, central service facilities, staff offices, or training facilities. Such institution must be operated by, or treatment given under direct supervision of a licensed physician. Types of hospitals include general, mental, chronic disease and allied special hospitals such as cardiac, contagious disease, maternity, orthopedic, cancer, and the like. Hospital does not include nursing homes, retirement facilities, shelters, or boarding houses.

HOTEL OR MOTEL: A facility offering transient lodging accommodations on a daily rate to the general public and potentially providing additional accessory services such as restaurants, meeting rooms and recreational facilities.

HOUSE-SIDE (SHIELD): Lighting industry term for an internal or external shield installed on a light fixture designed to limit light spill and glare to off-property locations.

- I -

ILLUMINATION, EXTERNAL: Illumination of a sign that is affected by an artificial source of light not contained within the sign itself.

IMPERVIOUS SURFACE: Any hard surfaced, man-made area that does not readily absorb or retain water, including but not limited to: building roofs, parking and driveway areas, sidewalks and paved recreation areas.

**IMPROVEMENT:** Any man-made building, structure, bridge, work of art, area, parking facility, public facility, fence, gate, wall, landscaping, or other immovable item that becomes part of, placed upon or is affixed to real estate.

**INCIDENTAL:** A minor occurrence or condition that is customarily associated with a permitted use and is likely to ensue from normal operations.

**INDUSTRIAL PARK:** A planned, coordinated development of a tract of land with two or more separate industrial buildings. Such development is planned, designed, constructed, and managed on an integrated and coordinated basis with special attention given to on-site vehicular circulation, parking, utility needs, building design, orientation and open space.

**INFILL DEVELOPMENT:** The development of new housing or other principally permitted buildings on scattered development sites in a developed or built-up area.

**INFRASTRUCTURE:** Facilities and services needed to sustain industry, residential, commercial, and all other land use activities, including utilities and streets.

**INGRESS:** Access or entry point.

**INSPECTORS:** Employees of the City authorized by the Community Development Director to enter, examine, and survey all lands within the City to accomplish the enforcement of this Ordinance and any other land use regulations of the City.

**INTEGRATED CENTER:** A group of commercial establishments planned, constructed and managed as a total entity with customer and employee parking provided on-site, provision for goods delivery separated from customer access, aesthetic considerations, and protection from the elements.

- J -

**JUNK:** Old or scrap copper, brass, rope, rags, batteries, paper, trash, rubber debris, waste, or junked, dismantled, or wrecked automobiles or automobile parts, iron, steel, and other old scrap ferrous or nonferrous material.

**JUNK YARD:** As defined by *O.C.G.A. 43-43-1*, as amended; An establishment or place of business that is maintained, operated, or used for storing, keeping, buying, or selling junk, or for the maintenance or operation of an automobile graveyard.

**JURISDICTION:** Any area over which a unit of government exercises power and authority.

- K -

**KENNEL, PRIVATE:** Any building or land designated or arranged for the care of more than a combined total of eight (8) dogs and/or cats, and limited further to a maximum of four (4) dogs and a maximum of four (4) cats, six (6) months of age or older, belonging to the owner of the principal use, kept for the purposes of personal enjoyment as pets, all of which have been sterilized (spayed or neutered) or more than a combined total of three (3) dogs and/or cats, six (6) months of age or older, belonging to the owner of the principal use, kept for the purposes of personal enjoyment as pets, that have not been sterilized.

**KENNEL, COMMERCIAL:** An establishment licensed to operate a facility housing domestic animals such as, but not limited to, dogs or cats, and where activities including, but not limited to, grooming, breeding, boarding, training or selling of animals are conducted as a business.

- L -

**LAND DISTURBANCE PERMIT:** A permit stating that the proposed erection, construction, enlargement, alteration, repair, improvement, removal, conversion, demolishing, or moving of a building or structure; alteration of the condition of the land; or change in the use or occupancy of a property complies with the provisions of this Ordinance.

**LANDSCAPING:** The improvement of a lot with grass, shrubs, trees, and other vegetation and/ or ornamental objects. Landscaping may include pedestrian walks, flower beds, berms, fountains and other similar natural and man-made objects.

**LANDSCAPING, DEFECTIVE:** Dead or dying plant material, damaged berms, walls, fences, and/or other landscaping elements.

**LDN CONTOUR:** A line linking together a series of points of equal cumulative noise exposure bases on the LDN metric.

**LIGHT INDUSTRIAL PROCESSING AND DISTRIBUTION:** Processing and distribution of materials and products from processed or previously manufactured materials. Light industry is capable of operation in such a manner as to control the external effects of processing such as smoke, noise, odor, etc.

**LIVING AREA:** The sum of the livable horizontal areas of a building measured from the interior faces of the exterior walls, exclusive of unfinished basements, unfinished attics and attached garages.

**LIVING AREA, GROUND FLOOR MINIMUM:** The sum or average, where designated, of the livable horizontal areas on the ground level of a residential building measured from the interior faces of the exterior walls, exclusive of attached garages and communal facilities such as multifamily laundry facilities or common rooms. The minimum for a specific residential structure shall be dependent on the number of stories within the residential structure.

**LIVING AREA, TOTAL MINIMUM:** The sum of the livable horizontal areas on all levels of a residential dwelling unit measured from the interior faces of the exterior walls, exclusive of basements, unfinished attics and attached garages. Each residential dwelling unit shall have separate and individual kitchen and bathroom facilities.

**LOADING SPACE, OFF-STREET:** Space logically and conveniently located for bulk pickups and deliveries, scaled to delivery vehicles expected to be used, and accessible to such vehicles when required off-street parking spaces are filled. Required off-street loading space is not to be included as off-street parking space. Off-street loading spaces shall be located totally outside of any street or alley right-of-way. An off street space, located on the same lot with a building or group of buildings, for the temporary parking of a commercial vehicle while loading or unloading merchandise, materials or goods.

**LOCATION MAP:** A drawing which shows the relationship of the proposed subdivision, Development Plan or use to other nearby developments or landmarks and community facilities and services in order to better locate and orient the area in question. Such map shall show the closest cross streets in all directions.

**LOT:** A parcel of land of sufficient size to meet minimum zoning requirements for use, coverage, and buildable area, and to provide such yards, setbacks, and other open spaces as required by this Ordinance. Such lot shall have frontage on an improved public street, or on a private street which meets City standards. A lot may be a single parcel separately described in a deed which is recorded in the Office of the County Recorder; or a lot may be a single parcel separately described in a survey which is recorded in the Office of the County Recorder; or a lot may include a parcel contained in a plat or subdivision of land which is recorded in the Office of the County Recorder; or a lot may include parts of, or a combination of, such parcels which are adjacent to one another and used as one. Each lot shall be limited to one (1) principal building and one (1) principal use and its accessory buildings.

**LOT AREA:** The horizontal area within the exterior lines of a lot, including any easements, but excluding any rights-of-way or other similar dedications to the public.

**LOT, BUILDABLE:** Any lot upon which improvements are permitted to be constructed, or which is otherwise allowed to be occupied and used consistent with all applicable requirements of this Ordinance.

**LOT, CORNER:** A lot or parcel of land abutting upon two (2) or more streets at their intersection, or upon two (2) parts of the same street forming an interior angle of less than one-hundred thirty-five (135) degrees.

**LOT COVERAGE:** The ratio of either enclosed ground floor area of all buildings; or the lot area that is covered, occupied or enclosed by buildings structures, parking areas, driveways, walkways, and other paved or impervious surface on a lot, to the horizontally projected area of the lot, expressed as a percentage.

**LOT COVERAGE (all impervious surfaces), MAXIMUM:** The maximum amount of ground floor area occupied by buildings, structures, parking lots, or other impervious surfaces on a lot expressed as a percentage of the horizontally projected area of the lot.

**LOT COVERAGE (structures and buildings), MAXIMUM:** The maximum amount of enclosed ground floor area of all buildings on a lot expressed as a percentage of the horizontally projected area representing the bulk and mass on the lot.

**LOT DEPTH:** The mean horizontal distance measured from the Front Lot Line to the Rear Lot Line, measured in the general direction of the Side Lot Line.

**LOT, DEVELOPED:** A lot upon which improvements have been made or is otherwise being used for human purposes.

**LOT, FLAG:** A lot not meeting the minimum frontage requirements and where access to the public road is by a narrow private right-of-way or driveway.

**LOT FRONTAGE:** The frontage of a lot shall be construed to be the portion adjacent to street right-of-way. For the purpose of determining setback and other lot requirements on corner lots and through lots, all sides of a lot adjacent to street right-of-way shall be considered frontage.

**LOT FRONTAGE, MINIMUM:** The minimum length for each lot frontage, which shall be measured between side lot lines at the street right-of-way or private street easement.

**LOT, INTERIOR:** Any lot which is not a corner lot or through lot.

**LOT, IRREGULAR:** A lot that is characterized by elongations, angles, shapes, and/or configuration that is inconsistent with the topography, street systems, other lots, and other features of the area in which it is located.

**LOT, KEY:** The first interior lot to the rear of a reversed corner lot.

**LOT LINE:** The property lines defining the legal boundary of a lot.

**LOT LINE, FRONT:** The line separating a lot from the adjacent street right-of-way on which the lot fronts. For a corner lot, the line marking the boundary between the lot and each of the abutting street rights-of-way.

**LOT LINE, REAR:** The Lot Line opposite and most distant from the Front Lot Line. In the case of an irregular or triangular-shaped lot, and for the purposes of determining any setback measured from the rear lot line, the rear lot line shall be an imaginary line at least ten (10) feet in length within the lot, parallel to and at the maximum distance from the Front Lot Line.

**LOT LINE, SIDE:** Any Lot Line other than a Front Lot Line or Rear Lot Line.

**LOT, MINIMUM AREA OF:** The smallest lot area established by this Ordinance on which a use or structure may be located in a particular district, and which does not include any street right-of-way.

**LOT, NONCONFORMING:** see “Nonconforming Use, Lot, Structure (Legal)” and “Nonconforming Use, Lot, Structure (Illegal)”

**LOT OF RECORD:** A lot which is part of a subdivision recorded in the Office of the County Recorder; or a lot or parcel described by metes and bounds, the description of which has been so recorded; or a parcel of land, the deed to which has been recorded in the Office of the County Recorder prior to the date of passage of this Ordinance.

**LOT, REVERSED FRONTAGE:** A lot on which frontage is at right angles to the general pattern in the area. A reversed frontage lot may also be a corner lot.

**LOT SIZE, MINIMUM:** The smallest area established by this Ordinance on which a use, structure or building may be located in a particular district and which does not include any street right-of-way.

**LOT, THOUGH:** A lot other than a corner lot having frontage on two (2) or more non-intersecting streets. Also referred to as Double Frontage Lot.

**LOT, UNDEVELOPED:** A lot of record upon which no improvements exist.

**LOT WIDTH:** The horizontal distance between the side property lines of a lot measured at right angles to its depth along a straight line parallel to the front lot line at the front setback line. Lot width on cul-de-sac lots and other lots with curving frontages is measured as a line parallel to the frontage and at the front setback line.

**LOT WIDTH, MINIMUM:** This refers to the minimum width a lot must have in order to be considered developable by this Ordinance.

**LUMINAIRE:** A complete lighting unit consisting of a light source and all necessary mechanical, electrical, and decorative parts.

- M -

**MAINTENANCE GUARANTEE:** Any security which may be required and accepted by Dallas City Council to assure that necessary improvements will function as required for a specific period of time.

**MANEUVERING AISLE:** A maneuvering space which serves two or more parking spaces, such as the area between two rows of parking spaces and/or the driveway leading to those spaces.

**MANEUVERING SPACE:** An open space in a parking area which is immediately adjacent to a parking space; is used for and/or is necessary for turning, backing or driving forward a motor vehicle into said parking space; but is not used for the parking or storage of motor vehicles.

**MANUFACTURED HOME PARK:** A parcel or contiguous parcels of land containing two (2) or more dwelling sites, with required improvements and utilities, that are either sold or leased for long term placement of Manufactured Home Dwellings. A Manufactured Home Park does not involve sales of Manufactured Home Dwellings in which unoccupied units are parked for inspection or sale.

**MANUFACTURING, HEAVY:** A use engaged in the processing and manufacturing of materials or products predominately from extracted or raw materials, or a use engaged in storage of, or manufacturing processes using flammable or explosive materials, or storage or manufacturing processes that potentially involve hazardous or commonly recognized offensive conditions which would generate objectionable or hazardous elements such as: heat, smoke, odor, vibration, water pollution, electromagnetic disturbances, radiation or dust.

**MANUFACTURING, LIGHT:** Manufacturing or other industrial uses which are controlled operations; relatively clean, quiet and free of objectionable or hazardous elements such as smoke, noise, odor, or dust; operating and storing within enclosed structures; and generating little industrial traffic and no nuisance.

**MASONRY:** Construction material that consists of brick, stone, tile, rock, granite, marble, or other built-up panels of these materials, or molded concrete that is held together with mortar, as long as the molded concrete does not make up a continuous wall section.

**MASSING:** The shape and form a building takes on through architectural design. There are ten (10) architectural design elements that create urban space;

- 1) building silhouette (similar pitch and scale to a roof line),
- 2) spacing between building facades (setbacks or notches between primary facades that frame the structure),
- 3) setback from property line (building setback and/or primary facade setback from the property line),
- 4) proportion of windows, bays, and doorways (vertical or horizontal elements tied together in bands across facade lengths),
- 5) proportion of primary façade (size of facades similar in area and height to width ratios),
- 6) location and treatment of entryway (important visual commonality between structures),
- 7) exterior materials used (similar materials and treatment add to detail and monumentality of a building),
- 8) building scale (similarity of building height and configuration),
- 9) landscaping (ties together buildings and defines space), and
- 10) shadow patterns form decorative features (the light and dark surfaces from materials used and projections from windows, bays, and setbacks create visual breaks). A specific project may not need to incorporate all ten (10) elements.

**MECHANICAL EQUIPMENT:** Equipment installed for a use appurtenant to the principal use. Such equipment may include heating and air conditioning equipment, solar collectors, parabolic antennas, and power generating devices.

**MEDIAN:** An area in the approximate center of a city street or state highway that is used to separate the directional flow of traffic, may contain left-turn lanes, and is demarcated by curb and guttering, having painted or thermally applied stripes or other means of distinguishing it from the portion of the roadway used for through traffic.

**METES AND BOUNDS:** A description of land prepared by a state-registered land surveyor providing measured distances and courses from known or established points on the surface of the earth.

**MIXED-USE DEVELOPMENT:** An area, parcel of land, or structure developed in a compact urban form for two (2) or more different, principal land uses, at least two (2) of which must be from separate use categories such as but not limited to residential, office, retail, service, public, light manufacturing, or entertainment, and planned as a unified complementary whole, and functionally integrated to the use of shared vehicular and pedestrian access and parking areas.

**MIXED USE STRUCTURE:** A building or structure which includes two (2) or more principal, compatible uses, at least two (2) of which must be from separate use categories such as but not limited to residential (not allowed on the ground floor), office, retail, service, public, light manufacturing, or entertainment, and planned as a unified complementary whole, and functionally integrated to the use of shared vehicular and pedestrian access and parking areas.

**MOBILE FOOD UNIT:** A self-contained vehicle, trailer or pushcart that serves prepared foods or prepares and serves food in various locations of the city.

**MOBILE FOOD UNIT PARK:** More than one mobile food unit (a.k.a. food truck park) located on a site larger than  $\frac{1}{4}$  acre.

**MOBILE HOME:** A structure, transportable in one or more sections, which, in the traveling mode, is eight feet or more in width or 40 body feet or more in length or, when erected on site, is 320 or more square feet and which is built on a permanent chassis and designed to be used as a dwelling with or without a permanent foundation when connected to the required utilities and includes the plumbing, heating, air-conditioning, and electrical systems contained therein.

**MODIFICATION:** A specific change or lessening of the regulations established by this Ordinance that may be initiated by the Planning & Zoning Commission for a specific development in response to

- 1) unique site characteristics or development patterns that justify relief from the otherwise generally applicable regulations, or
- 2) an alternative development proposal deemed by the Planning & Zoning Commission to meet the intent and spirit of this Ordinance and representing a creative and desirable application of different standards.

**MOTOR VEHICLE:** A mechanically propelled vehicle used on roads, with power from an internal or external source.

**MOTOR VEHICLE, COMMERCIAL:** Any motor vehicle used or designed:

- 1) for use in pulling, towing, hauling, transporting, or
- 2) as a temporary or permanent base, platform, or support for equipment, machinery, materials or other goods (including but not limited to stake body trucks, dump trucks, trucks or trailers having dual rear wheels or more than two (2) axles, semi-trailer tractors, semi-trailers and trailers having dual rear wheels or more than one (1) axle or having an overall length of more than twelve (12) feet;

- 3) passenger vehicles marked by signage, logos or commercial messages. This definition does not apply to motor vehicles which serve as a source of transportation for an individual residing at the premises where the vehicle is stored or parked on a regular basis and is not used in any commercial activity.

**MOTOR VEHICLE IMPOUND FACILITY:** A parcel of land or a building that is used for the storage of wrecked motor vehicles usually awaiting insurance adjustment or transport to a repair shop and where motor vehicles are kept for a period of time not exceeding forty-five (45) days and must remain mechanically operable and licensed at all times.

**MOTOR VEHICLE, INOPERABLE:** A motor vehicle which meets one (1) or more of the following conditions:

- 1) a vehicle from which the engine, transmission, or differential has been removed or that is otherwise partially dismantled or inoperable and left on public property, or;
- 2) a vehicle that is at least three (3) model years old, is mechanically inoperable, and is left on private property continuously in a location visible from public property for more than twenty (20) days, or;
- 3) a vehicle which does not carry a current year state registration or license tag, or a vehicle that cannot be driven legally on public roads due to, but not limited to, defects in brakes, brake lights, tail lights, head lights, windshields or exhaust systems.

**MOTOR VEHICLE REPAIR AND SERVICE, MAJOR:** An establishment primarily engaged in the repair or maintenance of motor vehicles, trailers, and similar large mechanical equipment, including paint, body and fender, and major engine and engine part overhaul.

**MOTOR VEHICLE REPAIR AND SERVICE, MINOR:** An establishment primarily engaged in the repair or maintenance of motor vehicles, trailers, and similar mechanical equipment, including brake, muffler, upholstery work, tire repair and change, lubrication, tune ups, and transmission work.

**MOTOR VEHICLE SALES, LARGE:** The sale, rental and display of new and used motor vehicles, including, but not limited to trucks, trailers, farm implements, mobile/manufactured homes, recreational vehicles, buses, boats, and heavy equipment, and similar size vehicles which have gross vehicle weights greater than ten-thousand (10,000) pounds (but not including repair work except incidental warranty repair) This does not include airplanes or aircraft.

**MOTOR VEHICLE SALES, SMALL:** The sale, rental and display of new and used motor vehicles, including, but not limited to, motorcycles, passenger cars, light trucks, vans, and similar size vehicles that have gross vehicle weights less than 10,000 pounds.

**MOTOR VEHICLE WRECKING:** The dismantling or wrecking of used motor vehicles, manufactured homes and trailers; or the storage, sale or dumping of dismantled, partially dismantled, obsolete or wrecked vehicles or their parts.

**MULTIPHASE DEVELOPMENT:** A development project that is constructed in stages, each stage being capable of existing independently of the others.

**MULTI-TENANT BUILDING:** A grouping of two (2) or more business establishments that either share common parking on the lot where they are located, or that occupy a single structure or separate structures that are physically or functionally related or attached.

- N -

**NONCONFORMING USE, LOT, STRUCTURE (Legal):** A continuous use, lot, or structure which was lawful prior to the adoption, revision, or amendment of this Ordinance but which fails by reason of the adoption, revision or amendment to conform to the present requirement of the zoning district. Also applies to uses, lots, or structures which have been granted a variance from this Ordinance, and therefore does not meet the lot-specific development standards. Legal nonconforming differs from illegal nonconforming in that the reason for the nonconformance is caused by the enactment of a Zoning Ordinance or a change to a Zoning Ordinance (including the official Zoning Map). The building, structure, lot or use has not changed, but due to the Zoning Ordinance enactment or change, the property no longer conforms to the standards of the zoning district in which it is located. When this situation occurs, the property is deemed legal nonconforming or “grandfathered”.

**NONCONFORMING USE, LOT, STRUCTURE (Illegal):** A use, lot, or structure that does not conform to the regulations of the zoning district in which it is located and was not lawful prior to the adoption, revision, or amendment of this Ordinance and was not granted a variance from this Ordinance. This applies to any use, building, structure or lot which is nonconforming, and was constructed or is being used without an approved Land Disturbance Permit or approval from the City Council or Planning & Zoning Commission. An illegal nonconforming use, building, structure or lot shall be subject to actions and penalties allowed by this Ordinance and shall be altered to conform with all applicable standards and regulations of this Ordinance and all other applicable City ordinances.

**NON-ELECTRIC VEHICLE:** Any motor vehicle that is licensed and registered for operation on public and private highways, roads, and streets that does not meet the definition of electric vehicle.

**NUISANCE:** Operations, activities, or general use of land which is injurious to health, indecent, offensive to the senses, or an obstruction to the use of property so as to interfere with the comfortable enjoyment of life or property.

- O -

**OBJECTIONABLE ODOR:** Odors that are nauseating, noxious, or generally recognized as unpleasant.

**OCCUPANCY:** The residing of an individual overnight in a dwelling unit; or the installation, storage or use of equipment, merchandise or machinery on the premises or in any public, commercial or industrial building; and/or the continuing use of land, building, or structures. A change in occupancy is not intended to include a change of tenants or proprietors.

**OCCUPIED SPACE:** The total area of earth horizontally covered by the structure, excluding garages, patios and porches and other accessory structures.

**OFF-SITE:** Located outside the property lines of the parcel in question.

**OFFICIAL ZONING MAP:** The legally adopted map showing the legally established boundaries and the zoning districts within the City as adopted by the Dallas City Council.

**ON-SITE:** Located within the property lines of the parcel in question.

**OUTBUILDING:** A separate accessory building or structure not physically connected to the principal building.

**OUTDOOR SALES AND DISPLAY:** Outdoor sales and display shall include merchandise for retail sale, whether seasonal or not.

**OUTDOOR STORAGE:** The storage of any materials outside the principal or accessory buildings on a property for more than twenty-four (24) hours, provided, however, that truck and/ or tractor-trailer unit parking associated with a legally established warehouse or distribution center shall not be deemed outdoor storage.

**OUTPARCEL:** A lot platted as part of a larger development that is intended for the development of uses and structures which are complementary to but of a smaller scale than the principal use or structure in the development.

- P Q -

**PACKAGE STORE:** An establishment engaged in the retail sale of packaged alcoholic beverages, such as ale, beer, wine, and distilled spirits for consumption off the premises and at which on-premises consumption is specifically prohibited. The term "package store" is considered synonymous with the term "liquor store" and "Liquor Outlets." A package store shall include any premises classified as Industry No. 5921 in the Standard Industrial Classification (SIC) Manual 1972, prepared by the Executive Office of the President, Office of Management and Budget. The term "package store" shall not include a "wine specialty shop" and shall not include a city food market.

**PARAPET:** The portion of a wall which extends above the roof line.

**PARCEL:** Any legally established piece of land designated by the owner or developer as land to be used or developed as a unit, or that has been developed as a unit.

**PARKING LOT:** An open off-street area to be used for the storage of motor vehicles, whether free or for compensation, for limited periods of time. A parking lot includes all parking spaces, interior drives, and maneuvering areas.

**PARKING, OFF-STREET:** A temporary storage area for a motor vehicle, with room to open doors on both sides, that is directly accessible to an access aisle and which is not located on a dedicated street right-of-way.

**PARKING, ON-STREET:** A temporary storage area for a motor vehicle that is located on a dedicated street right-of-way.

**PARKING, SHARED:** A parking space or lot used jointly by two (2) or more uses or structures.

**PARKING SPACE:** A space within a public or private parking area for the storage of one (1) motor vehicle.

**PARKING STRUCTURE:** A structure of two or more stories, whether privately or publicly owned, used for parking.

**PARTICULATE MATTER:** Finely divided liquid or solid material which is discharged and carried along in the air. This shall not include water droplets, commonly called steam.

**PATHWAY:** A designated route for travel by pedestrians, bicycles, and other non-motorized methods of personal transportation and recreation which is surfaced with crushed rock, concrete, or asphalt and separated from streets by distance or striping.

**PAVED SURFACE:** A durable surface for parking, driving, riding or similar activities that utilizes asphalt, Portland cement, concrete, brick, paving blocks, pervious pavement, or similar material. Crushed gravel, street grindings, stone, rock, or dirt, sand or grass are not a paved surface.

**PEDESTRIAN SCALE:** The proportional relationship between the dimensions of a building or building element, street, outdoor space, or streetscape element and the average dimensions of the human body, taking into account the perceptions and walking speed of a typical pedestrian. Examples include ornamental lighting no higher than twelve (12) feet; bricks, pavers, or other paving modules with small dimensions; a variety of planting and landscaping materials; arcades or awnings that reduce the perception of the height of walls; and signage and signpost details designed for viewing from a short distance. The use of a pedestrian scale can imbue occupants and users of the built environment with a sense of comfort and security.

**PERFORMANCE GUARANTEE:** An agreement by a developer with the City for the amount of the estimated construction cost guaranteeing the completion of physical improvements according to plans and specifications within the time prescribed by the developer’s agreement.

**PERSONAL CARE HOME:** A residence providing the protective care of residents who do not require chronic or convalescent medical or nursing care. Personal care involves responsibility for safety of the resident while inside the building and may include daily awareness by the management of the residents functioning and whereabouts, making and reminding a resident of appointments, the ability and readiness for intervention in the event of a resident experiencing a crisis, supervision in the areas of nutrition and medication, and the actual provision of transient medical care.

- 1) Personal Care Home, Congregate: Means a home for persons which offers care to sixteen (16) or more persons
- 2) Personal Care Home, Group: Means a home for persons in a residence or other type building(s), non-institutional in character and appearance, which offers care to seven (7) through sixteen (16) persons.
- 3) Personal Care Home, Family. A home for persons in a family type residence, no institutional in character an appearance, which offers care to two through six persons.

**PERSONAL SERVICE:** Any enterprise conducted for gain which primarily offers services to the general public such as a health club, fitness facility, barber shops, beauty parlors, nail salons, and similar activities but excluding sexually oriented business.

**PERVIOUS PAVEMENT:** A hard surface that presents an opportunity for precipitation to infiltrate into the ground.

**PERVIOUS SURFACE:** A surface that presents an opportunity for precipitation to infiltrate into the ground.

**PETITIONER:** Any person who formally makes a request before the Planning & Zoning Commission or City Council consistent with the processes and requirements of this Ordinance.

**PLACE OF WORSHIP:** The use of a building and/or property by a non-profit group/congregation of people who regularly attend, participate in, or hold religious services, meetings and other activities, including incidental uses commonly associated with such a facility, such as a daycare center or school. Place of worship includes church, synagogue, temple, mosque or any other like facility used for worship and religious activities.

**PLANNED UNIT DEVELOPMENT:** A large-scale unified development meeting the requirements of this Ordinance. Generally a planned unit development consists of a parcel or parcels of land, controlled by a single person, to be developed as a single entity, containing a single type of land use or a combination of land uses including but not limited to single-family residential, multi-family residential, public, quasi-public, commercial or industrial uses, which does not correspond in size of lots, bulk or type of buildings, density, lot coverage, and required open space to the regulations established in any zoning district of this Ordinance.

**PLANTING SEASON:** The spring and fall time periods during which new plant material which is installed is most likely to survive the planting process. Generally, these periods are from April 15<sup>th</sup> to June 15<sup>th</sup> in the spring and from October 15<sup>th</sup> to November 15<sup>th</sup> in the fall.

**PLAT, FINAL:** The final map of all or a portion of a subdivision or Development Plan that contains all information or detail required by law and by these regulations, and is presented to the proper review authority for final approval.

**PLAT, PRELIMINARY:** An initial map of a subdivision of land or Development Plan that is presented to the proper review authority for preliminary approval.

**PLUG-IN HYBRID ELECTRIC VEHICLE:** Any vehicle that is licensed and registered for operation on public and private highways, roads, and streets; either partially or exclusively, on electrical energy from the grid, or an off-board source, that is stored on-board via a battery for motive purpose. An electric vehicle that (1) contains an internal combustion engine and also allows power to be delivered to drive wheels by an electric motor; (2) charges its battery primarily by connecting to the grid or other off-board electrical source; (3) may additionally be able to sustain battery charge using an on-board internal-combustion-driven generator; and (4) has the ability to travel powered by electricity.

**PORCH:** A covered, but otherwise unenclosed structure projecting out from the wall or walls of a main structure.

**PRACTICAL DIFFICULTY:** A difficulty with regard to one's ability to improve land stemming from regulations of this Ordinance. A practical difficulty is not a "hardship," rather it is a situation where the owner could comply with the regulations within the Zoning Ordinance, but would like a variance from the Development Standards to improve his/her site in a practical manner. For instance, a person may request a variance from a side setback due to a large tree which is blocking the only location that would meet the Development Standards for a new garage location.

**PRELIMINARY APPROVAL:** An approval (or approval with conditions) granted to a subdivision or Development Plan indicating that it has determined after a public hearing that the proposal complies with the standards prescribed in this Ordinance.

**PUBLIC HEARING:** A formal meeting, announced and advertised in advance consistent with the requirements of this Ordinance, which is open to the public, and at which members of the public have an opportunity to participate.

**PUBLIC IMPROVEMENT:** Any drainage ditch, street, highway, parkway, sidewalk, pedestrian way, tree, lawn, off-street parking area, lot improvement, or other facility for which the local government may ultimately assume the responsibility for maintenance and operation, or which may affect an improvement for which local government responsibility is established.

**PUBLIC SAFETY AND NUISANCE:** Anything which is injurious to the safety or health of an entire community, neighborhood or any considerable number of persons, or unlawfully obstructs the free passage or use, in the customary manner, of any navigable lake, or river, bay, stream, canal, or basin.

**PUBLIC USE:** Public parks, schools and administrative and cultural structures not including public land or buildings devoted solely to the storage and maintenance of equipment and materials and public service facilities.

**PUBLIC WAY:** An alley, avenue, boulevard, bridge, channel, ditch, easement, expressway, freeway, highway, land, parkway, right-of-way, road, sidewalk, street, subway, tunnel, viaduct, walk or other ways in which the general public or a public entity have a right, or which are dedicated, whether improved or not.

- Q -

**QUARRY:** A lot or any part of a lot used for the extracting of stone, sand, gravel, or any other material to be processed for commercial purposes.

- R -

**RECORD:** The written documentation of the actions and expressions of a public body, such as the Planning & Zoning Commission or City Council.

**RECREATION, ACTIVE:** Leisure activities, usually performed with others, often requiring equipment and taking place at prescribed places, sites, and fields. Activities include, but are not limited to, swimming, tennis, and other court games, baseball and other field sports, and playground activities.

**RECREATION, PASSIVE:** The use of unimproved land, in its natural state, which provides for a variety of activities for the outdoor exercise and activity needs of the community. Passive recreation areas shall include, but are not limited to: unimproved backpacking trails, unimproved hiking trails, riding stables, primitive camping areas, canoeing and rafting areas.

**RECREATIONAL VEHICLE:** A vehicle which is

- 1) built on a single chassis;
- 2) four-hundred (400) square feet or less when measured at the largest horizontal projection;
- 3) designed to be self-propelled or permanently towable by a light duty truck; and
- 4) designed primarily not for use as a permanent dwelling, but as temporary living quarters for recreational camping, travel, or seasonal use. Recreational vehicles include pick-up truck coaches, motorized homes, boats, travel trailers, snow mobiles, and camping trailers not meeting the definition of a manufactured or mobile home.

**RECYCLABLE MATERIAL:** Any material that can be converted into a raw material for use in a manufacturing process. Recyclable materials include but are not limited to glass, metal and plastic containers and paper products.

**REPAIR SERVICES:** Establishments that provide repair services to individuals and households, rather than businesses, not including automotive and equipment repair. Typically, such services include the repair of appliances, watches, jewelry, and musical instruments.

**REPLAT (or Re-subdivision):** Any change in a recorded plat which does not result in the creation of additional lots. It may include all or any part of a previous subdivision or plat. A replat shall be considered an Administrative Subdivision, provided no new streets or utility expansions are required.

**RESEARCH ACTIVITY AND TESTING LABORATORY:** Research, development and testing related to such fields as chemicals, pharmaceutical, medical, electrical, transportation and engineering. All research, testing and development, whether conducted within or outside of buildings shall create no noise, smoke, glare, vibration or odor which can be detected outside of the buildings or property line. A research and testing laboratory shall mean a building in which scientific research, investigation, testing or experimentation is conducted, but not including the manufacturing or sale of products, except as incidental and accessory to the main purpose of the laboratory.

**RESTAURANT:** An establishment with or without table service whose principal business is the selling of unpackaged food and beverages to the customer in a ready-to-consume state, in individual servings or in non-disposable containers regardless of whether consumption is on or off the premises.

**RESTAURANT, DRIVE-IN:** A facility, including a building and adjoining parking area, the primary function of which is selling food to the public by order from and service to passengers in vehicles parked outside of the structure. Drive-in restaurants may also provide seating inside of the building.

**RESTAURANT, FAST-FOOD:** An establishment whose principal business is the sale of already prepared or rapidly prepared food, in disposable containers, directly to the customer in a ready-to-consume state for consumption either within the restaurant building or off-premises. Orders are generally not taken at the customer's table, and food is generally served in disposable wrapping or containers.

**RETIREMENT FACILITY:** A residential complex containing multifamily dwellings designed for and occupied by senior citizens (persons sixty (60) years of age or older, or couples where either the husband or wife is sixty (60) years of age or older). Such facilities may include a common gathering and dining facilities, but exclude nursing care.

**REZONING:** An amendment to the official Zoning Map which has the effect of removing property from one zoning district and placing it in a different zoning district.

**RIGHT-OF-WAY (R.O.W.):** A strip of land acquired by reservation, dedication, forced dedication, prescription or condemnation and intended to be occupied or occupied by a road, crosswalk, railroad, electric distribution or transmission line, telephone line, oil or gas pipeline, water line, sanitary or storm sewer and other similar uses.

**RIGHT-OF-WAY LINE:** The limit of publicly owned land encompassing a public facility, such as a street or an alley.

**RINGELMANN NUMBER:** The number of the area on the Ringelmann Chart that most nearly matches the light-obscuring capacity of smoke. The Ringelmann Chart is published by the U.S. Bureau of Mines, and it illustrates graduated shades of gray for use in estimating smoke density. Smoke below the density of Ringelmann No. 1 shall be considered no smoke, or Ringelmann "0."

**ROADSIDE STAND:** A structure not permanently fixed to the ground that is readily removable in its entirety, covered or uncovered and not wholly enclosed, and used for display and sale of products grown or produced on or off site. Sales are conducted on a temporary or seasonal basis.

RUNOFF: The surface water discharge or rate of discharge of a given watershed after a fall of rain or snow that does not enter the soil but runs off the surface of the land.

- S -

SALES, INCIDENTAL: Sales that are related and subordinate to the primary service or retail activities of a commercial use.

SALES, TEMPORARY/SEASONAL: Facilities that are indoor or outdoor and operate on a temporary basis for the sale of seasonal fruits and vegetables, fireworks, Christmas trees, and/or other holiday, event, or season related products.

SALVAGE YARD: A facility or area for storing, selling, keeping, dismantling, shredding, compressing or salvaging scrap or discarded material or equipment. Scrap or discarded materials shall include, but are not limited to: metal, paper, rags, tires, bottles, motor vehicles, motor vehicle parts, machinery, structural steel, equipment and appliances.

SATELLITE DISH/ANTENNA: An apparatus capable of receiving communications from a transmitter relay located in a planetary orbit or broadcasted signals from transmitting towers.

SCREENING STRIP: A strip of land to be used as a planting strip on which shall be placed evergreen, hedge, shrubbery or other planting materials maintained in a neat and orderly manner for the purpose of limiting visibility.

SECONDARY APPROVAL: An approval by the official designated by the Planning & Zoning Commission indicating that all conditions of Preliminary Approval have been met.

SETBACK LINE: A line indicating the minimum horizontal distance between the right-of-way of any street, or the property line of the side and rear yards, and a part of any structure regardless of whether it is the front, side, or rear of the building. It is an imaginary line established by this Ordinance that requires all buildings to be set back a certain distance from the property lines. The line is generally parallel with and measured from the appropriate Lot Line (front, side, or rear).

SETBACK, FRONT: The horizontal space between the right-of-way lines as established by the current Thoroughfare Plan and the Front Setback Line, extending to the side lines of the lot, generally parallel with and measured from the front lot line, defining the area in which no building or structure may be located above ground, except as may be provided in this Ordinance. The front setback applies to all frontages of a lot facing a street or right-of-way. The setback is usually based on the classification of the road on which the building is located, as determined by the *Transportation Element of the Paulding County Comprehensive Plan*.

SETBACK, REAR: The horizontal space between the Rear Lot Line and the Rear Setback Line, extending to the side lines of the lot, generally parallel with and measured from the rear lot line, defining the area in which no building or structure may be located above ground, except as may be provided in this ordinance. For through lots, the rear of the structure facing a street shall meet front setback requirements. Rear Setbacks for Corner Lots will apply to the portion of the lot that is furthest in the opposite direction of the general orientation of the structure.

**SETBACK, SIDE:** The horizontal space between the Side Lot Lines and the Side Setback Lines, extending to the Front and Rear Lot Lines, generally parallel with and measured from each side lot line, defining the area in which no building or structure may be located above ground, except as may be provided in this Ordinance. However, for corner and through lots, any side of a structure that faces a street shall meet front setback requirements.

**SHIPPING CONTAINER:** Originally, specifically or formerly designed for or used in the packing, shipping, movement or transportation of freight, articles, goods or commodities; and/or designed for or capable of being mounted or moved by rail, truck or ship by means of being mounted on a chassis or similar transport device. This definition includes the terms “transport containers” and “portable site storage containers” having a similar appearance to and characteristics of cargo containers.

**SHRUB, ORNAMENTAL:** A shrub planted primarily for its ornamental and screening value, not to be confused with a perennial.

**SIDE YARD SEPARATION:** The sum of the distance of the horizontal space between a foundation and side Lot Line, plus the horizontal space between the foundation and shared side Lot Line of the structure on the immediately adjacent lot.

**SIDEWALK:** A paved surfaced or leveled area, usually parallel to and separate from the street, used as a pedestrian walkway.

**SIGHT VISIBILITY TRIANGLE:** Triangular shaped areas on each corner of an intersection that are looked through by drivers approaching or departing an intersection to view oncoming vehicular/pedestrian/etc. traffic on crossing streets and roadways.

**SLOPE:** The face of an embankment or cut section. Any ground whose surface makes an angle with the plane of the horizon. Slopes are usually expressed in a percentage based upon vertical difference in feet per one-hundred (100) feet of horizontal distance.

**SMOKE UNIT:** The number obtained when the smoke density in Ringelmann number is multiplied by the time of emission in minutes. For the purpose of this calculation, a Ringelmann density reading shall be made at least once a minute during the period of observation; each reading is then multiplied by the time in minutes during which it is observed. The various products are then added together to give the total number of smoke units observed during the entire observation period.

**SOLID WASTE COLLECTION FACILITY:** Establishments that

- 1) collect or haul hazardous waste, non-hazardous waste, or recyclable materials within a locale area; and
- 2) operate hazardous or nonhazardous waste transfer stations. Waste collection establishments may be responsible for the identification, treatment, packaging, and labeling of waste for the purposes of transport.

**SPECIAL EXCEPTION:** A special use, that is a use not permitted in a particular district except by a special use permit granted under the provisions of this chapter and any zoning ordinances adopted herewith.

**SPOT ZONING:** The zoning of a typically small area of land controlled by a single or limited number of property owners that results in the property involved being granted permitted uses and/or development standards that are inconsistent with those provided to, or planned for, similar surrounding properties.

**STOP-WORK ORDER:** A written document issued by an enforcement official which requires the cessation of an activity.

**STORAGE FACILITY, SELF-SERVICE:** A building or group of buildings in a controlled access environment that contains varying sizes of individual, compartmentalized, and controlled access stalls or lockers for the temporary storage of customer's goods or wares.

**STORAGE, SEMI-TRACTOR/TRAILER:** The storage of any vehicle without motive power designed to be coupled with or drawn by a motor vehicle and constructed so that some part of its weight and that of its load rests upon or is carried by another vehicle.

**STORY:** The part of a building between the surface of a floor and the ceiling immediately above, or if there is no floor above, then the space between such floor and the ceiling or roof above. Unless otherwise defined, this distance shall be set at eight (8) feet. For the purpose of this Ordinance, a basement shall not be considered a story unless it has been subdivided into rooms and used for tenant purpose.

**STREET, HALF:** A street for which only half of the required right-of-way and/or pavement width has been provided.

**STREET (or Alley) IMPROVEMENT:** Shall mean the construction of a street or alley to its full thickness, commencing at the subgrade according to the specifications contained in this Ordinance. The placing of a new surface over an existing paved or closed surface street or alley shall not be considered as an improvement but as maintenance.

**STREET INTERSECTING:** Any street that joins another street at an angle, whether or not it crosses the other street.

**STREET INTERSECTION:** The point of crossing or meeting of two (2) or more streets.

**STREET, NON-RESIDENTIAL:** Any street where the principal land use of the lots which the street provides access to, as well as the lots on either side of the street is not residential.

**STREET ORIENTATION:** The direction of the architectural front facade of a building in relation to the street.

**STREET, PRIVATE:** A privately maintained thoroughfare which affords principal means of vehicular access to more than one (1) abutting property or dwelling unit, and which has not been dedicated to the public, or subject to public easements.

**STREET, PUBLIC:** A public thoroughfare which has been dedicated to the public use and accepted and maintained by the City, affording the principal means of access to abutting property and which has been identified and defined by the Atlanta Regional Commission as:

- 1) Interstate
- 2) Urban Principal Arterial
- 3) Rural Principal Arterial
- 4) Urban Minor Arterial
- 5) Rural Minor Arterial
- 6) Urban Collector
- 7) Rural Collector
- 8) Local Road

**STREET RIGHT-OF-WAY LINE:** A dividing line between a lot, tract or parcel of land and a contiguous street. Where the lot, tract or parcel of land has been conveyed to the center of the street, the street right-of-way line then becomes the inside line of land reserved for street purposes.

**STRUCTURAL ALTERATION:** Any change in the supporting members of a building or structure, such as bearing walls or partitions, columns, beams, foundations or girders, or any increase in the area or cubical contents of the building or structure. Also, substantial roofing and siding work when repairs are made to the structure beneath.

**STRUCTURE:** Any object constructed or installed by man, including but without limitation, buildings, towers, smokestacks and overhead transmission lines.

**STRUCTURE, ACCESSORY (APPURTENANT STRUCTURE):** A structure that is subordinate and incidental to a principal structure in area, intent, and/or purpose; contributes to the comfort, convenience, or necessity of occupants of the principal structure; does not alter or change the character of the property; and is located on the same lot as the principal structure. Accessory structures should constitute a minimal initial investment, may not be used for human habitation, and be designed to have minimal flood damage potential. Examples of accessory structures are billboards, detached garages, carports, storage sheds, pole barns, and hay sheds.

**STRUCTURE, PRINCIPAL:** The building or structure in which the principal use of the lot or premises is located or conducted. With respect to residential uses, the principal building or structure shall be the main dwelling. For agricultural uses, the principal structure may be a barn or other agricultural structure.

**SUBDIVISION:** The division of a parcel of land into two (2) or more lots, parcels, sites, units, plats, or for the purpose of sale, lease, or development, either on the installment plan or upon any and all other plans, terms, and conditions, including re-subdivision. Subdivision includes the division and development of land opened for residential and non-residential uses, whether by deed, metes and bounds description, devise, intestacy, lease, map, plat, or other recorded instrument. The following kinds of division of existing parcels of land are exempt from the Dallas Subdivision Ordinance:

- 1) A tract, which is at least twenty (20) acres in size;
- 2) A division of land for the sale or exchange of tracts to correct errors in an existing legal description, provided that no additional building sites other than for accessory buildings and/or structures are created by the division;
- 3) A division of land for the acquisition of street right-of-way or easement;
- 4) A division of land for the sale or exchange of tracts between adjoining land owners, provided no additional building sites other than for accessory buildings and/or structures are created by the division;
- 5) A division of land into cemetery plots for the purpose of burial of corpses;
- 6) A division of land to be subdivided for agricultural use only, provided that no additional building sites are created by this division; and a division of land containing a minimum of one (1) acre of lot area and having ever been located on such lot the principal residence.

**SUBDIVISION, EXEMPT:** A subdivision of a parent tract of land for the purpose of splitting off an existing legally conforming residence and accessory structures, provided that (1) the new residential parcel meets all current development standards applicable to a residential parcel in the relevant zoning district, and (2) the remaining parent parcel is at least twenty (20) acres in size.

**SUBDIVISION, MAJOR:** All subdivisions not classified as minor subdivisions and resulting in the creation of more than three (3) lots, including but not limited to subdivisions requiring any new street or extension of utilities or the creation of any public improvements.

**SUBDIVISION, MINOR:** The subdivision of a parent parcel into any combination of not more than three (3) contiguous or non-contiguous new residential, commercial, or industrial building sites whether at the same time or over the course of time, and which does not involve the construction or extension of public or private streets or utilities. The parcel shall front upon an existing street which is an improved right-of-way maintained by the City or other governmental entity and not involve any new street.

**SUBDIVISION, MINOR RESIDENTIAL:** The subdivision of a parent tract into one (1) new residential building site, and a remainder, which does not involve the construction or extension of public or private streets, or under the standards set forth in this ordinance, does not involve substantial improvement or realignment of any existing city, county, or state road. To qualify as a minor residential subdivision, the proposal must meet all of the conditions set forth in this ordinance for minor residential subdivisions.

**SUBSTANTIAL DAMAGE:** Substantial Damage: Damage of any origin sustained by a structure whereby the cost of restoring the structure to its before damaged condition would equal or exceed fifty (50%) percent of the market value of the structure before the damage occurred.

**SUBSTANTIAL IMPROVEMENT:** Any reconstruction, rehabilitation, addition, or other improvement of a structure, the cost of which equals or exceeds fifty (50%) percent of the market value of the structure before the “start of construction” of the improvement. This term includes structures which have incurred “substantial damage” or repetitive loss regardless of the actual repair work performed. The term does not include improvements of structures to correct existing violations of state or local health, sanitary, or safety code requirements or any alterations of a “historic structure,” provided that the alteration will not preclude the structures continued designation as a “historic structure.”

**SURETY:** An amount of money or other negotiable instrument provided by a developer to the City which guarantees that they will perform all actions required by the City regarding an approved site Development Plan, plat, or other improvement, which provides that if the developer fails to comply with the requirements of approval, funds will be provided for the City to complete those requirements.

- T -

**TECHNICAL ADVISORY COMMITTEE (TAC):** A committee established by the City of Dallas to assist with the technical evaluation of subdivisions and Development Plans by reviewing sketch plats, and to make appropriate technical recommendations to the developer, Planning & Zoning Commission, or other City departments. The TAC includes the Departments of Community Development, Public Works, City Manager, and Public Safety officials where applicable, and may seek additional outside consultation in the evaluation of a development application.

**TECHNICAL REVIEW:** A process prior to Development Plan approval in which detailed technical information pertaining to all applicable local building, fire and City and County Codes are presented to and reviewed by the City for conformance.

**TELECOMMUNICATIONS ANTENNA:** Any structure or device, including all appurtenances, used for the purpose of collecting or radiating electromagnetic waves, including those used to transmit cellular telephone service, data, radio and television signals, and any other information.

**TEMPORARY STRUCTURE:** A structure without any foundation or footings and which is removed when the designated time period, activity or use for which the temporary structure was erected has ceased.

**TIMBER, HARVESTING:** The cutting and removal of trees from their growing site, and the attendant operation of cutting and skidding machinery but not the construction or creation of roads. Timber harvesting does not include the clearing of land for construction approved under this ordinance.

**TOPOGRAPHY:** The configuration of the earth's surface, including the relative relief, elevations, and position of land features.

**TOWER:** A ground pole, spire, structure, or combination thereof including supporting lines, cables, wires, braces, and masts intended primarily for the purpose of mounting an antenna, a meteorological device, or other similar apparatus above ground.

**TOWNHOUSE:** A single-family dwelling with a private entrance that is attached horizontally to other dwelling units in a linear arrangement, with a front and a rear wall that are totally exposed for light, access, and ventilation.

**TRACT:** A unit, or contiguous units, of land under single ownership.

**TRAFFIC CALMING:** Methods of reducing the negative impact of vehicles on surrounding land uses and other methods of personal transportation through street design that decreases the speed of vehicles and provides increased space and comfort for pedestrians.

**TRAIL:** A public way, separate from a street, alley, or other vehicle roadway, designed for and used by pedestrians, cyclists, and others using non-motorized transportation and recreation equipment.

**TRANSFER STATION:** A facility that receives and temporarily stores solid waste as defined by this ordinance at a location other than the generation site, and which facilitates the transfer of accumulated solid waste to another facility for further processing or disposal. This term includes any solid waste handling facility, but does not include recovered materials processing facilities, nor portable storage containers used for the collection of municipal solid waste.

**TREE, BROADLEAF:** Trees having non-needle like leaves.

**TREE, DECIDUOUS:** Trees and shrubs that shed their leaves annually.

**TREE, EVERGREEN:** Trees and shrubs that do not shed their leaves annually.

**TREE, ORNAMENTAL:** A deciduous tree possessing qualities such as flowers or fruit, attractive foliage, bark or shape, with a mature height generally under forty (40) feet.

**TREE, PROHIBITED:** A tree, as listed in this Ordinance that does not meet site-landscaping or performance standard requirements.

**TREE, SHADE:** A deciduous tree planted primarily for its high crown of foliage or overhead canopy.

- U -

**UNDERDEVELOPED PARCEL** - An underdeveloped parcel or lot is a parcel that contains a residential unit, commercial use or industrial use that does not take advantage of the full density or intensity permitted in the underlying zoning classification. For the purposes of this definition an underdeveloped parcel or lot shall refer only to a lot which is in a configuration which will allow the parcel or lot to be re-divided or utilized for additional development or use in conformance with the requirements of Table 4.4 of this ordinance and/or parcels with structures that are vacant for more than twelve (12) consecutive months. Lots used solely for shared parking arrangements shall be considered underdeveloped lots.

**UNDEVELOPED PARCEL** - An undeveloped parcel or lot is one that does not contain structures and has the capacity to be developed for uses in compliance with the underlying zoning classification. Land in its natural state before development. Also known as unimproved land.

**USE:** The purpose of which land, building, or structure thereon is designed, arranged, or intended, or for which it is occupied, maintained, let, or leased. In the classification of uses, a “use” may be a use as commonly understood or the name of an occupation, business, activity or operation carried on, or intended to be carried on in a building or on premises, or the name of a building, place or thing which name indicates the use or intended use.

**USE, ACCESSORY:** A use or structure on the same lot with, and of a nature customarily incidental and subordinate to, in terms of size, intent, and/or purpose, the principal use or structure, and does not alter or change the character of the property.

**USE CATEGORY:** A group of similar use types that are associated with each other to such an extent that they are grouped together for the purpose of identifying land uses by this Ordinance, such as retail uses, office uses, personal service uses, and general industrial production.

**USE, CHANGE OF:** The discontinuation of the specific principal use of a lot or structure and the replacement of that use with a different specific use.

**USE, EXISTING:** The use of a lot or structure present at the time of the enactment of this Ordinance.

**USE, ILLEGAL:** Any use that is neither legal nonconforming or permitted by right or special exception in the zoning district in which it is located as defined by this Ordinance.

**USE, PERMITTED:** Any use listed as a permitted use in this Ordinance or which is an accessory or temporary use associated with a permitted use for the zoning district in which it is located.

**USE PETITION (ALSO LAND USE PETITION):** A rezoning petition, variance petition, special exception petition, or any other petition permitted by rules of procedure adopted by the Planning & Zoning Commission.

**USE, PRINCIPAL:** The primary or predominant use of land or structures, as distinguished from an accessory use. A principal use may be either a permitted use or a special exception.

**USE, SPECIAL EXCEPTION:** Uses that, because of potential incompatibility and negative impact on the immediate neighborhood, require a greater degree of scrutiny and review of site characteristics and impacts to determine their suitability in a given location. Special exception uses are permitted only following approval by the City Council.

**USE, TEMPORARY:** A land use or structure established for a limited and fixed period of time with the intent to discontinue such use upon the expiration of the time period.

UTILITY SUBSTATION: A building or structure used for the distribution or transmission of utilities such as water, gas, electricity, or sewer.

- V -

VARIANCE: A grant of relief from the requirements (development standards such as height, bulk, area, etc.) of this ordinance, which permits construction in a manner otherwise prohibited by this ordinance, where the modification will not be contrary to the public interest, and where owing to conditions peculiar to the property and not a result of action of the applicant, a literal enforcement of the regulations would result in a practical difficulty or an unnecessary hardship.

VERTICAL FOOTCANDLES: The amount of light striking a vertical plane or surface.

VESTED RIGHT: A right that has become fixed and cannot be revoked by subsequent changes of applicable regulations.

VICINITY MAP: A drawing located on a plat which shows by dimensions or other means, the relationship of the proposed subdivision or use to other nearby developments or landmarks and community facilities and services within the City of Dallas in order to better locate and orient the area in question.

VIOLATION: The failure of a structure or other development to be fully compliant with this Ordinance. A structure or other development without the elevation, other certification, or other evidence of compliance required in this ordinance is presumed to be in violation until such time as that documentation is provided.

- W X -

WALKWAY/BIKEWAY: A dedicated public way, four (4) feet or more in width, for pedestrian or bike use, whether along the side of a road or not.

WAREHOUSE: A use engaged in storage, wholesale, and distribution of manufactured products, supplies, and equipment, and not involved in manufacturing or production.

WATER SYSTEM, CENTRAL: A system where individual lots are connected to a common water distribution system whether publicly or privately owned and operated.

WHOLESALE FACILITY: An establishment or place of business primarily engaged in selling and/or distributing merchandise to retailers, to industrial, commercial, institutional, or professional business users, or to other wholesalers.

WIDTH, LIVING AREA FACADE MINIMUM: The minimum width required for the front facade of a residential structure, exclusive of garages, porches, decks, or terraces. This requirement may apply to a continuous facade for multi-family or single-family attached units.

WINE AND CRAFT BEER BOUTIQUE: An establishment selling Georgia wine products and other fine wines and craft beer under a limited pouring license by the taste, drink, original package or growler for the purposes of promoting tourism in certain designated areas of the city.

WIRELESS TELECOMMUNICATIONS FACILITY: A tract, lot or parcel of land that contains the cellular or wireless communications tower, antenna, support structure(s), parking and any other uses associated with and ancillary to cellular or wireless communications transmission.

- Y Z -

**YARD:** A space on a lot that is open, unoccupied and unobstructed other than by steps, walks, terraces, driveways, lamp posts and similar structures. Front, side, and rear yards shall be considered those yards that exist in the space between the structure or applicable facade (front, side, or rear) and the applicable lot line (front, side, or rear).

**ZERO LOT LINE:** The location of a building on a lot in such a manner that one or more of the building's sides rests directly on a Lot Line.

**ZONING DISTRICT:** An area within the Dallas Planning & Zoning Commission's jurisdiction for which uniform regulations governing the use, height, area, size, intensity of use of buildings and land, and open spaces about buildings, are herein established.

**ZONING INSPECTOR:** The Planning and Building Director or the duly appointed administrative officer designated to administer the Zoning Ordinance.

**THIS PAGE INTENTIONALLY LEFT BLANK**